

deluge

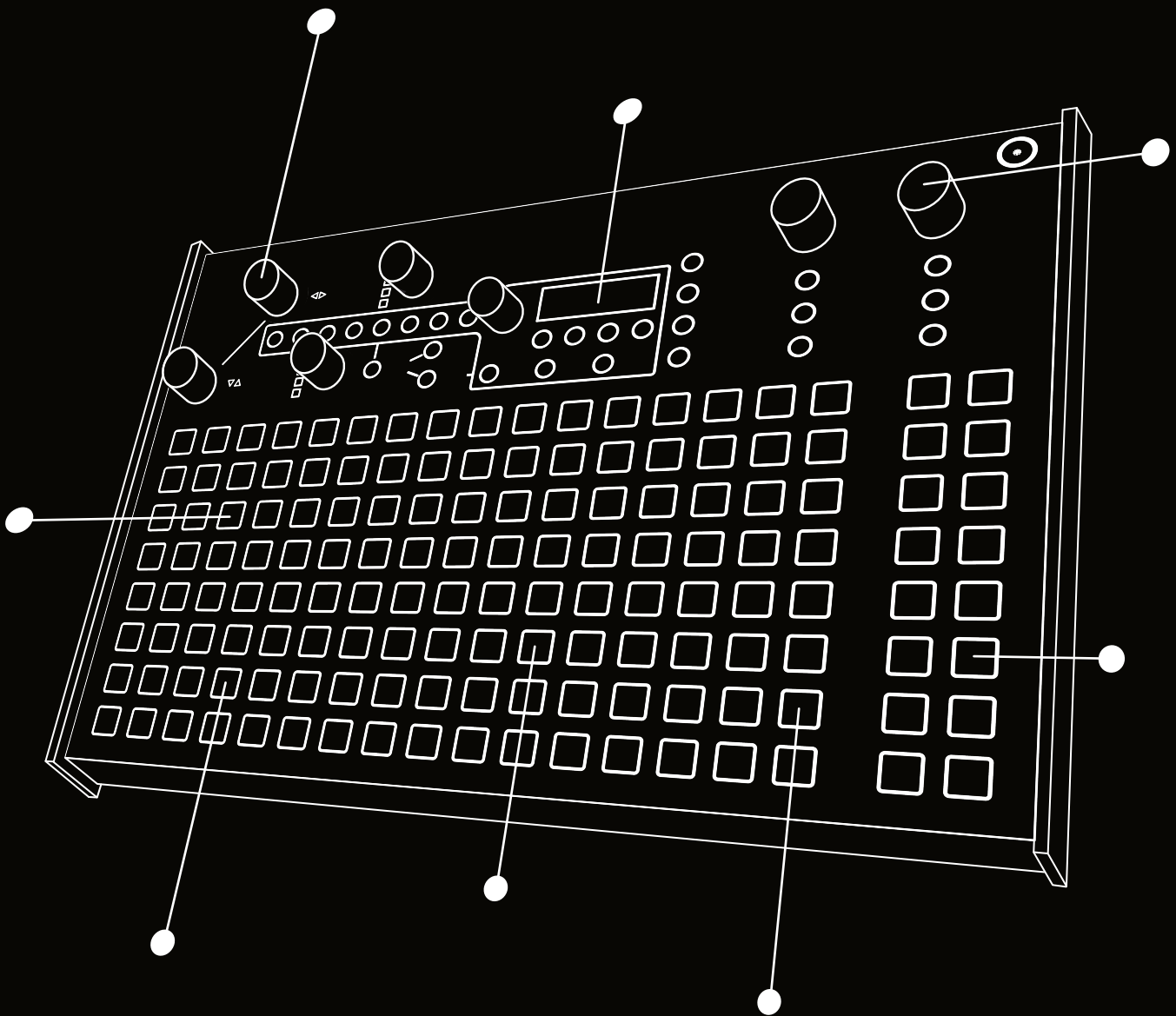

The Official Guidebook



OS
4.0

SANTHSTROM AUDIBLE

MORE THAN JUST A MANUAL
Guidebook - Reference - Notebook

SYNTHSTROM AUDIBLE



Contents

OVERVIEW	1
BASIC OPERATION	11
SEQUENCING	33
SYNTHESIZERS	73
KITS	107
MODULATION	117
SONG VIEW	135
ARRANGER VIEW	153
AUDIO	169
LOOPING	199
EFFECTS	213
MIDI	235
CV	265
SYSTEM & GENERAL	275
COMMUNITY GUIDE	295
INDEX	323

OVERVIEW

1 Overview

1.1 How to Use This Manual

This book is a formal reference to the Deluge, bringing together a comprehensive guide along with your own notes. Some pages are intentionally left blank and may contain wide margins enabling you to make your own notes on the specific topics covered.

The conventions used in this guide are:-

(OUTPUT LEVEL)

Curved parentheses / brackets represent the context sensitive rotaries indicated on Deluge in black or gold colour. These controls adjust parameters based on the specific context. The upper control for the parameters is referred to as (UPPER) likewise for lower control. Commands such as rotate - TURN or press - PRESS will accompany the command within the instructions.

[LEVEL / PAN] or [GRID]

Square parentheses and standard text contain functions that are selectable by the circular buttons on the upper control area. Grid buttons are shown with *italic font* within square parenthesis.

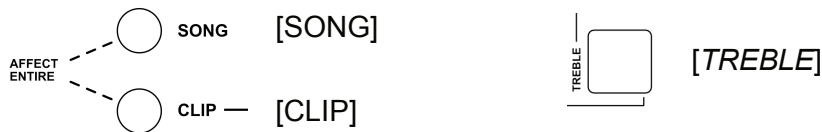

[SHIFT] + [BROWSE]

Functions which require multiple button selections simultaneously are shown with a + symbol between each button command. Some functions operate with a SHIFT button. These as labelled on the Deluge faceplate within a 'box' and are located under the primary function label or when representing a shortcut on the grid:-

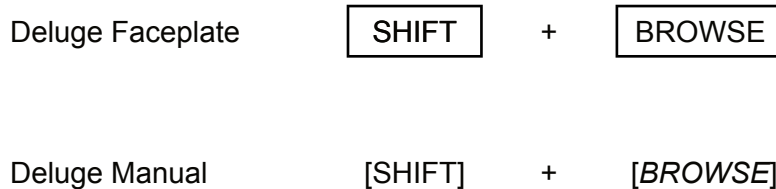

Where multiple labels are attached to a control for the primary or the [SHIFT] + secondary function, only the command name / label relevant to the context of the instruction will be used, for example SAVE or DELETE.

1.2 What's in the Box

Deluge is supplied with:-

Deluge

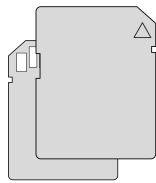
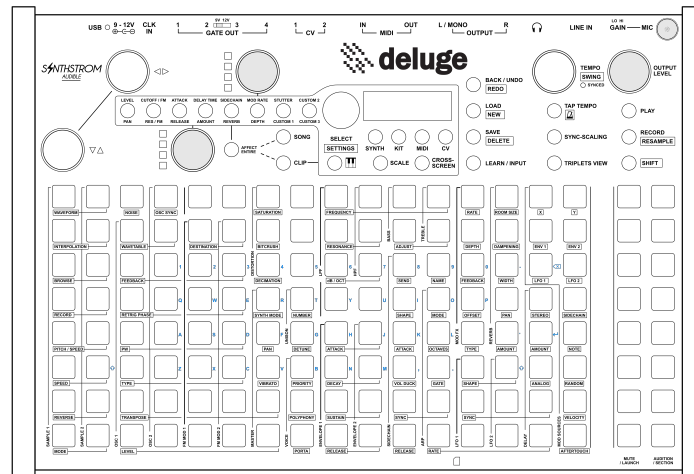

1 x 32GB SD card populated with presets and samples.



1 x USB cable type USB-B to USB-A



This guidebook. PDF located on the SD Card

Deluge is not supplied with:-

9-12v DC PSU. The supplied USB cable provides a charging option for Deluge.

An optional external DC supply, centre-negative (not centre-positive), 500mA or greater can also be used. Using an incorrect power supply may cause damage to the Deluge.

Hardcopy version of the producer guide is available from the Synthstrom store and the latest PDF version as a free download from the Synthstrom site.

1 Overview

1.3 Hardware Overview

- 1 Power LED**
Illuminates yellow for charging, green when charge is complete or red for low-battery.

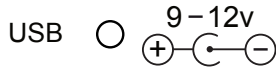

- 2 Zoom & Scroll**
Horizontal (SCROLL ◀▶) and vertical (SCROLL ▼▲) navigation through the grid. Press and turn (SCROLL ◀▶) will zoom in and out of the grid.

- 5 Parameter Controls**
Adjusts and affects the selected parameter, as labelled above the button (UPPER) in context with the clip type: kit, synth etc
Adjusts the selected parameter, as labelled below the button (LOWER) in context with the clip type kit, synth etc...

- 6 Parameter Selection**
Select the parameter to be adjusted. The label above and below the selection can be controlled by the (UPPER) & (LOWER) rotaries. Other parameters can be configured in the sound editor.

- 7 Pad Grid**
16 x 8 grid for sequencing. Also contains shortcuts using [SHIFT] + where columns represent Deluge function groups and row pad represents a parameter.

- 8 Alpha Numeric Keyboard**
Pads are used for text entry for example when entering names using the QWERTY keyboard.

- 9 Keyboard Mode**
Switches synth, MIDI, or CV clip view from the normal grid to an isomorphic keyboard [KEYBOARD] representation.

- 3 Select Control**
(SELECT) rotary control used for selecting patches, parameters and navigating menus.

- 4 Song or Clip View**
Select between song, arranger and clip view. Also enables parameter changes to 'affect all' functions within the context selected.

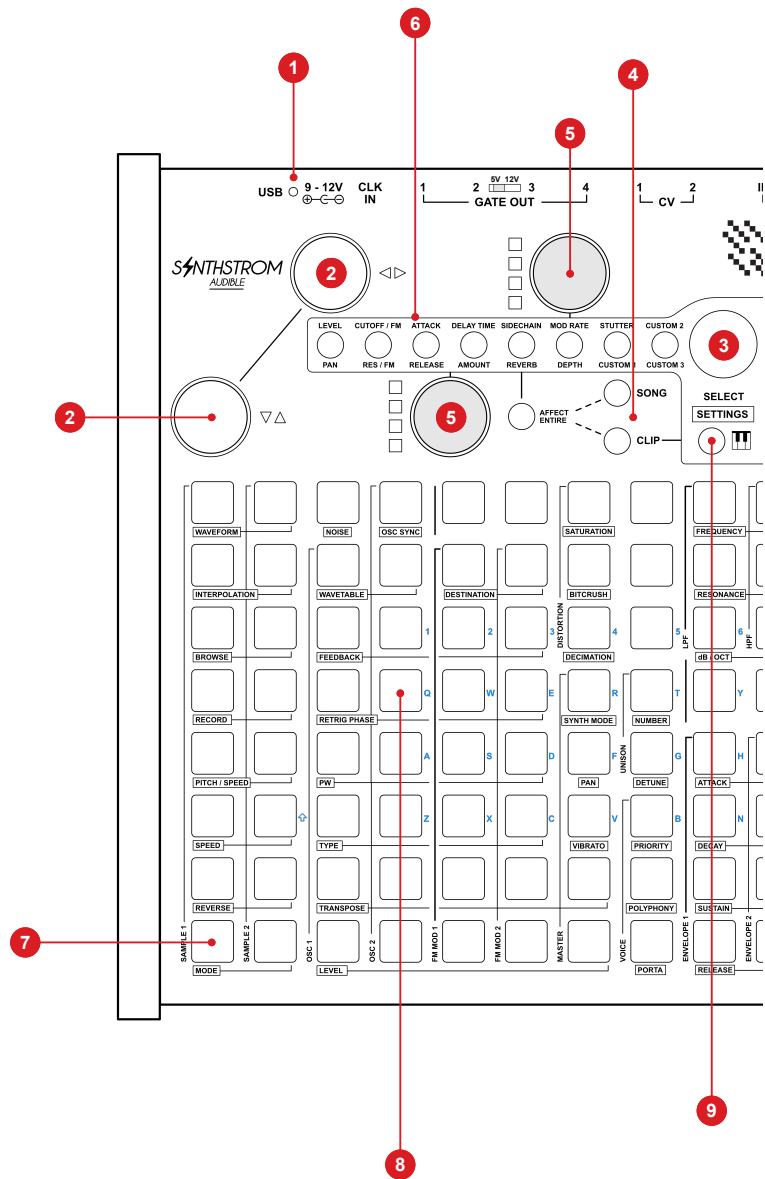

10 Scale
Sets the scale [SCALE] mode and locks clips to the major scale or can be used to change scales.

11 Clip Type
Used to select the clip type between [SYNTH], [KIT], [MIDI] and [CV].

12 Cross Screen Edit mode
[CROSS SCREEN] ensures any changes to the grid view will be reflected in the grid areas that are not in view.

13 Navigation Group
Navigates through the menus, saves, loads and also assigns controls.

14 Tempo & Timing Group
[TAP] to set tempo by tapping or turn (TEMPO) to set the tempo.

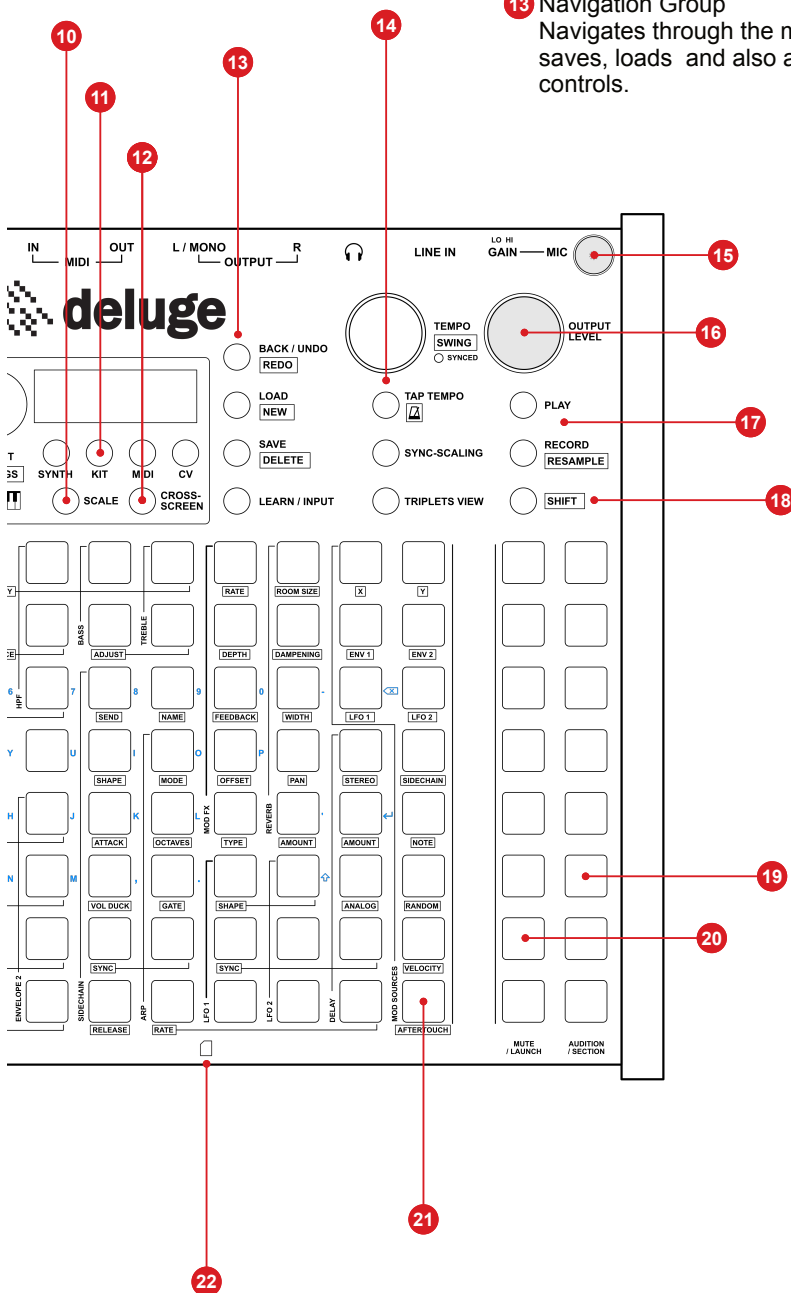

15 Internal Microphone

16 Main Output
(LEVEL) to adjust main output volume and headphone volume.

17 Mode Group: Transport Controls
Sequencer [PLAY] and STOP. Also [RECORD], loop and resample.

18 Shift
Used in conjunction with pads and buttons to select the secondary [SHIFT] function.

19 Audition / Section
Column of pads are manually playable individually across 1 octave or as chords to play each of the designated sounds. Also to launch a [SECTION].

20 Mute / Launch
Pads are manually selectable to [MUTE] or unmute clips / rows and [LAUNCH] clips.

21 Modulation Section
Grid area where modulation sources are located and can be selected.

22 SD Card Slot

1 Overview

Rear Panel

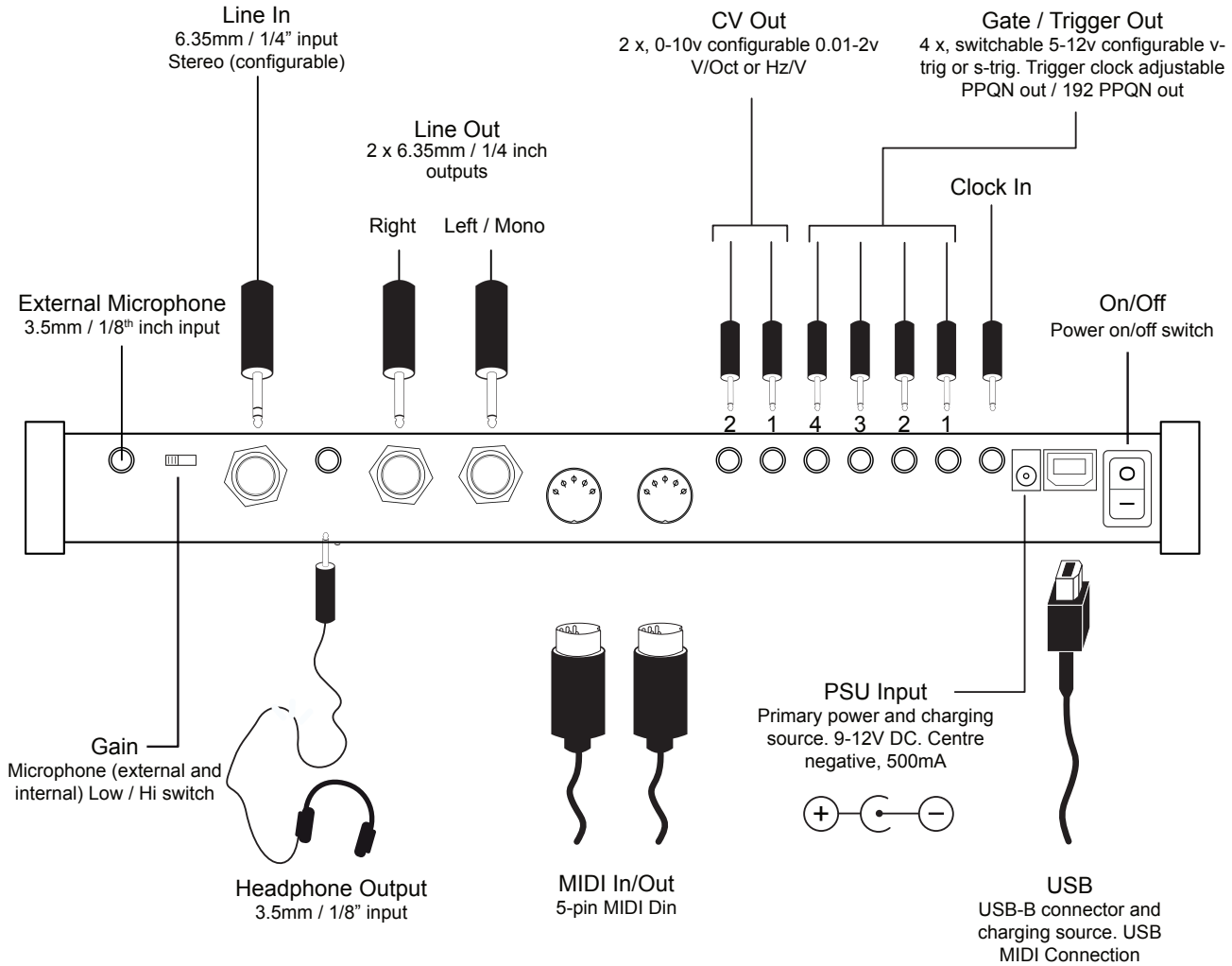

Front Panel

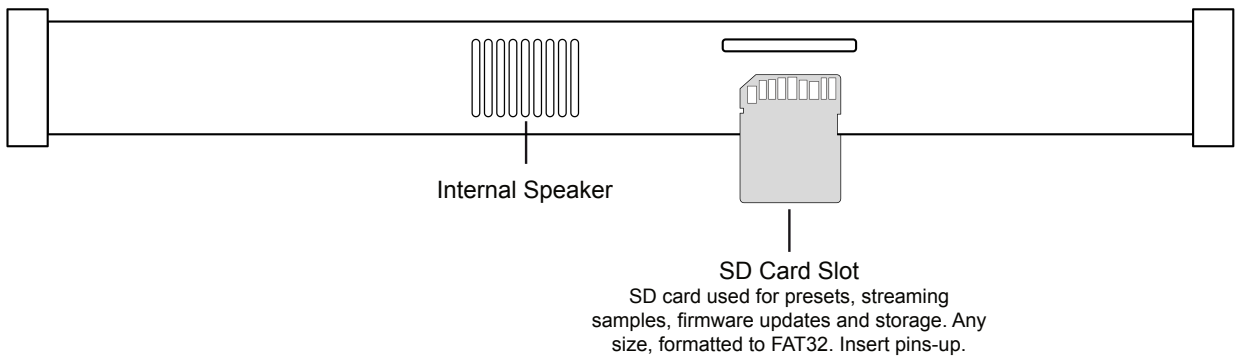

USB

The Deluge's USB type-B connection enables several functions. This can be used as a connection to your computer as a USB MIDI device, for use in any software that supports MIDI. The Deluge may also be powered by its USB connection - either from a computer, or from a USB wall adaptor with an appropriate cable. The Deluge may draw up to 500mA from its power source. Deluge also can be used as a USB Host. This requires Deluge to be DC powered, a USB device connected and then Deluge to be powered up.

DC Power Socket (9 - 12V)

The Deluge may be powered by any centre-negative 9 - 12V DC power supply which can provide at least 500mA. It can be a shared power supply with other units in a typical daisy chained pedal configuration only if the power supply can provide adequate current. The Deluge contains circuitry to minimise ground loop noise in such a setup, although some noise may still be introduced. DC and USB power may be connected simultaneously, in which case the Deluge will draw its power from the DC power supply rather than USB.

It is important to remember that the 9 - 12V DC power supply must be centre-negative, not centre-positive. Using the incorrect power supply may cause damage to the Deluge.

Battery

The Deluge has an internal Li-ion battery, providing 6+ hours of life. The battery charges any time a power source is connected to the USB or DC power socket, regardless of whether the Deluge is switched on. The battery status LED illuminates yellow for charging, green for charge-complete, or red for low-battery.

The Deluge's battery is an "18650" 3.7V Li-ion, and may be replaced by the user. These batteries are readily available from stores everywhere. A "protected" or "unprotected" type may be used. A battery of any mAh rating may be used - higher mAh ratings simply mean longer battery life.

Please note that your Deluge will be shipped with very little charge in the battery. You will need to plug it into a power source to use it and begin charging the battery.

1 Overview

SD card slot

The Deluge uses SD (or SDHC) card storage to load and record audio samples, store presets and save songs. Typically a 16GB or 32GB is recommended, but any size can be used, formatted to FAT32. The Deluge's firmware can also be updated via the SD card.

L / MONO and R outputs

The Deluge's main audio outputs are two quasi-balanced (that is, resistor-balanced but not differential) 1/4" connectors. They will work with non-balanced cables too. For best noise rejection, use balanced cables when connecting the Deluge's outputs to balanced / differential inputs. Output impedance: 47 ohms.

Deluge will detect if only the "L / MONO" output has a cable inserted (but not the "R" output or headphone output), and will output all sound in mono. In this case all panning and ping-pong delay will be deactivated, and stereo samples will be condensed to mono. This allows you to work on your music on a stereo setup, but not necessarily need to change anything if you are faced with a mono setup.

Headphone output

This can drive headphones, or can be used to connect other equipment with a 3.5mm / 1/8" connector - perhaps computer speakers or a car stereo.

Line input

For recording from another device's line output. The line input uses TRS 1/4" / 6.35mm connector, which may accept a single-ended / unbalanced signal, a differential / balanced signal, or a stereo signal. Input impedance: 4k.

Mic input

For recording with an external microphone use the 3.5mm / 1/8" jack. Gain is set via the "mic gain" switch, which also affects the internal microphone. Stereo and mono microphones are supported. 4.5V plug-in power is supplied on the tip and ring of the connector, each through a 3.9k resistor.

CV, gate, and trigger clock ("CLK IN") connectors

These all have the signal on their "tip", ground on their "sleeve", and their "ring" connected to ground via a 10k resistor.

1.4 System Architecture

Deluge high level overview of the system configuration.

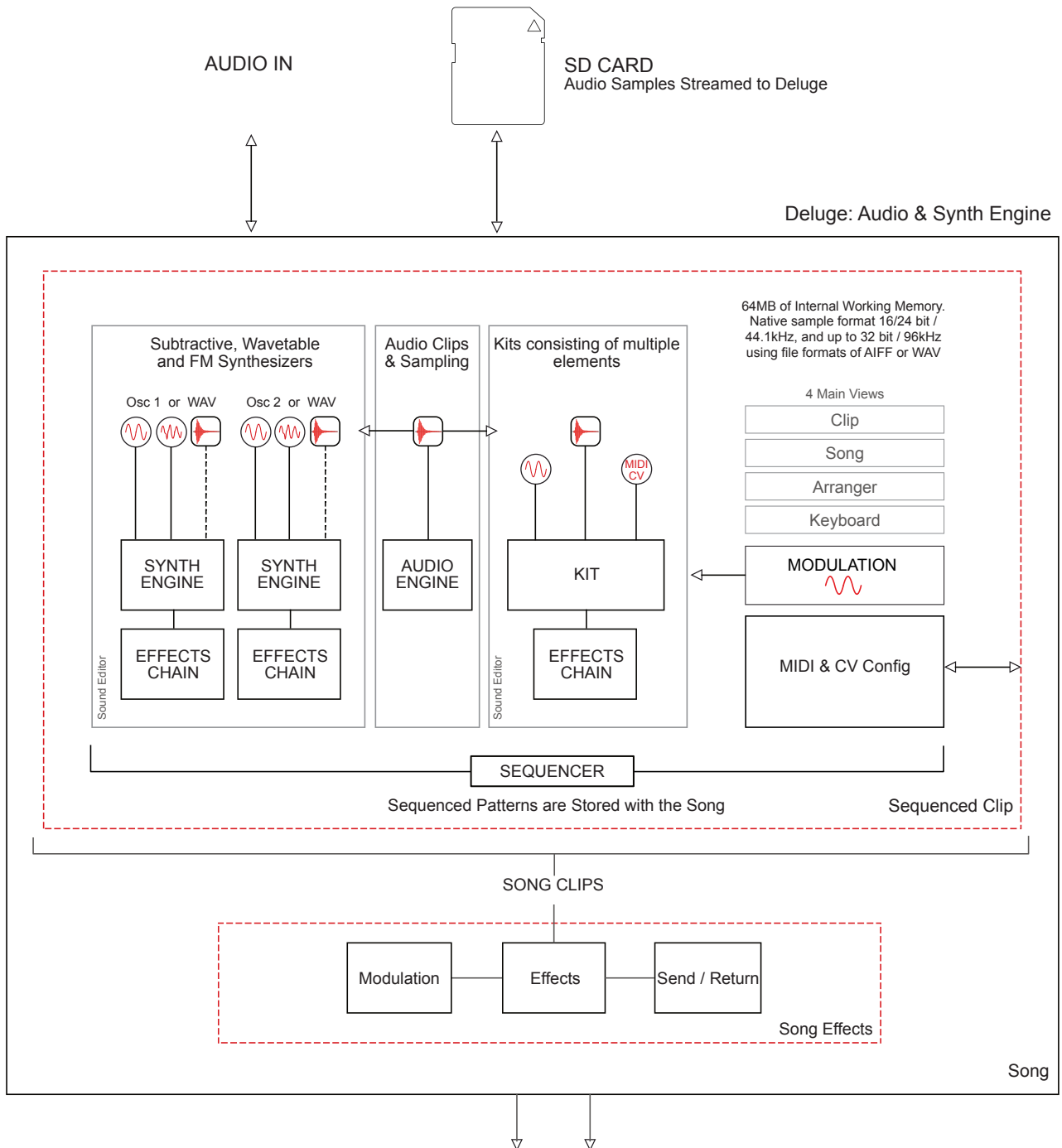

This is an illustration of the general architecture and functions of the Deluge and is not intended as a detailed schematic diagram

—— BASIC OPERATION ——

2 Basic Operations

2.1 Factory Library

NOTES

The Deluge is supplied with a formatted SD card loaded with the factory library. Samples are streamed directly from the SD card when in use, making it an integral part of the device. Ensure the card is inserted in Deluge when in use.

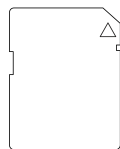
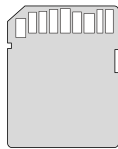

SD CARD

Formatted to FAT32. Any size card can be used. Factory library is held on the SD Card.

Insert the SD card with the power on or off and the card 'pins' facing up.

File Structure

Deluge's SD card contains the presets for kits and synths in XML format which stores the parameter settings and for kits points to the specific samples used.

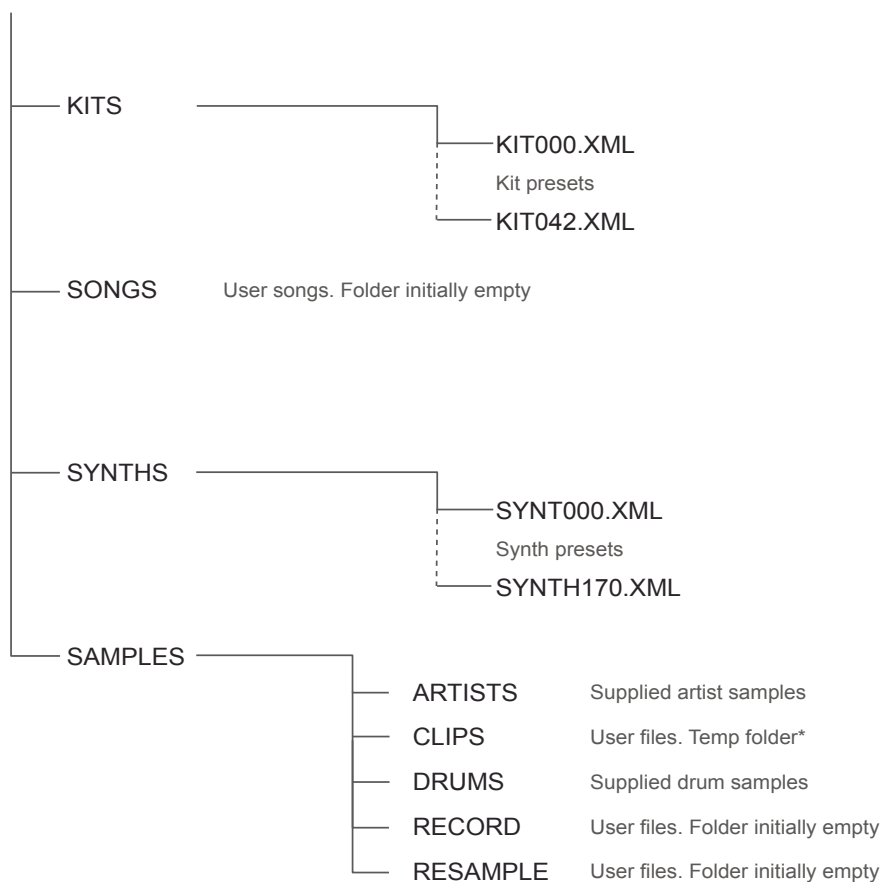

*TEMP Sub folder within CLIPS is managed by the system and is not accessible directly within Deluge.

Synth Presets ver 2.1

#	Name	Artist	#	Name	Artist
0	Rich Saw Bass		44	8-Bit Lead	
1	Sync Bass		45	Square Sync	
2	Basic Square Bass		46	Saw Sync	
3	Synthwave Bass	Marcel Bellve	47	Basic Dirty Bass	
4	Dubby Bass		48	Thin Pulse Bass	
5	Sweet Mono Bass	Marcel Bellve	49	Basic FM	
6	Vaporwave Bass		50	FM Basic Bass	
7	Detuned Saw Bass		51	FM Rich Bass	
8	FM Rich Distorted Bass		52	Soft Synth	
9	Hoover Bass		53	Detuned FM Horns 3	
10	Gravel Basscamp	NJM	54	Ghostly Sines 6	
11	Dubstep Bass	Guilherme Gomes	55	FM Theremin 6	
12	Blunt Sync Bass		56	FM Bell Modulation 10	
13	Trap Bass 1		57	FM Lead	
14	Trap Bass 2	Steve Swisher	58	FM Rising Attack	
15	Resonant Filter Bass		59	Distorted Guitar Lead	
16	Dark Saturated Bass	Marcel Bellve	60	Bass Guitar	
17	Impact Saw Lead		61	Blown / Staccato / Panpipes	Marcel Bellve
18	Rich Saw Lead		62	Trumpet	
19	Fizzy Strings	Marcel Bellve	63	Tuba	
20	Soft Saw Lead		64	Reeds / Flute / Oboe	Marcel Bellve
21	80's TV Lead		65	Cello	
22	Rich Filter LFO Lead		66	Violin	
23	Analog Mono Wow	Marcel Bellve	67	Marimba	
24	Warble Bass Pluck	Marcel Bellve	68	FM Bells 1	
25	Soft Synth Organ		69	FM Bells 2	
26	PW Organ		70	Glockenspiel	
27	PW Envelope		71	Rhodes	
28	PWM		72	Kyoto Phono	NJM
29	Chiptune Trill	Stephen Scofield	73	Piano	
30	Distant Porta	Luke Rowell	74	Electric Piano	
31	Nasal Choir		75	Electric Piano with Strings	
32	Bandpass Choir		76	Organ	
33	Rich Square		77	FM Perc / Organ	Matt Bairstow
34	Square Choir	Ron Cavagnaro	78	House 1	
35	Bell Lead & Bass	Guilherme Gomes	79	Phased Arper	Jeremy Blake
36	Analog Ambient Square	Marcel Bellve	80	House 2	
37	Echo Chord	Jeremy Blake	81	Xylophone Big Bass	Guilherme Gomes
38	Vapor Arp	Joey Esposito	82	Short Sharp Delay	
39	Detuned Retriggering Saws		83	Dark Chorus	
40	Spacer Leader	NJM	84	FM Narrow Band	
41	Zithar - Vibed	Marcel Bellve	85	Deep Fizz	Jani Hakala
42	High Triangle		86	Techno Organ	Pawel Czubak
43	Square Porta		87	Define Leader	NJM

2 Basic Operations

Synth Presets ver 2.1 (cont)

#	Name	Artist	#	Name	Artist
88	Yelp Chords	Matt Bairstow	132	Organ Strings	
89	Degraded Retro Lead	Jeremy Blake	133	80s Strings	Guilherme Gomes
90	FM Organ		134	Melody Strings	Ron Rapprich
91	FM Ricochet		135	Soothing Growth Pad	Stephen Scofield
92	Degraded Tremolo		136	Synthwave Pad	Marcel Bellve
93	FM Distorted Bells		137	Epic Saw Modulation Pad	Marcel Bellve
94	Ambient Occlusion Lead	Jeremy Blake	138	Brassy Pad	
95	Harsh FM Feedback		139	Detuned Saw Pad	
96	FM Guitar Power Chord		140	Slow Aural Swells	Daniel Stern
97	Saturated Filter		141	Ringmod Pad	
98	Saturated Sync		142	Phaser	
99	Overdrive Reese Sync	Pawel Czubak	143	Chillout Pad	Ron Rapprich
100	Noise Lead	Matt Bairstow	144	Sweep Chords	Matt Bairstow
101	Atebit	Jani Hakala	145	Eerie High Pad	
102	Harsh 5th		146	Atmosphere Squares Pad	Brad Antone
103	Sci-Fi Chaos	NJM	147	Resonant Filter Pad	Brad Antone
104	Alien Vomit		148	Warm 5 th Pad	
105	Attack Bass	Pawel Czubak	149	Cold 5 th Pad	Travis Hampton
106	Hang Drum	Marcel Bellve	150	Vaporwave Pad	Jeremy Blake
107	FM LPG Percussion	Neil Baldwin	151	Radiant FM Pad	
108	Robo Arp	Marcel Bellve	152	Small Jet Pad	NJM
109	Talking Arp	Marcel Bellve	153	FM Modulation Pad	Ron Rapprich
110	Crystalline Ringmod	Brad Antone	154	Rich FM Pad 1	
111	Satellite Drum	Franz Keller	155	Rich FM Pad 2	
112	Hard Tech Beat	Franz Keller	156	Rich FM Pad 3	
113	Bio Lab	Franz Keller	157	Rich FM Pad 4	
114	Sootheerio	Jani Hakala	158	Tempo-Synced LFO	
115	Sounds Like After Take Off	Daniel Stern	159	80s Bass Rhythm	Stephen Scofield
116	Evolving Frequencies	Daniel Stern	160	Synthwave Bass Arp	Marcel Bellve
117	Belledy	Jani Hakala	161	Synthwave Vibrato Arp	Marcel Bellve
118	Small Bridge Pad	NJM	162	Busy Arp	Marcel Bellve
119	Stars Of The Bin Pad	Jeremy Blake	163	Crisp Pop Arp	Marcel Bellve
120	High Harsh Pad	Marcel Bellve	164	Study Arp	NJM
121	Tiny Lights	Michael Bath	165	Acid Arp	
122	Majestic Synth Orchestra	Franz Keller	166	Harpsichord Cyborg	Franz Keller
123	Space Dust		167	FM Metallic Bass Arp	Pawel Czubak
124	Filter Modulation Pad		168	Hang Drum	Leonard Ludvigsen
125	Evolving Pad	Guilherme Gomes	169	Double Bass	Leonard Ludvigsen
126	Dark FM Pad		170	Sitar	Michael Bulaw
127	Alien Larvae				
128	Lunar Landing	Brad Antone			
129	Sci-fi Scenic	Brad Antone			
130	Dark Strings	Guilherme Gomes			
131	Warm Strings				

Kit Presets ver 2.1

#	Kit	Artist Kit	#	Kit	Artist Kit
0	TR-808		20		Leonard Ludvigsen
1	DDD-1		21		<<hodeur>>
2	SDS-5		22		<<hodeur>>
3	TR-909		23		<<hodeur>>
4	R-50		24		James R Closs
5	R-100		25		James R Closs
6	LD		26		amiga909
7	HR-16B		27		Reciprocal Sound
8	SCDT		28		Danny Taurus
9	RX-5		29		Danny Taurus
10	XV-5080		30		Chaz Bundick
11	KR-55		31		Reuben Winter
12	HR-II		32		Kody Nielson
13	AT Rhythm		33		Alfred Darlington
14	CR-78		34		Travis Egedy
15		Andrew Stirton (Frugal)	35		Sjionel Timu
16		Electronisounds	38		Stefanie Franciotti
17		Electronisounds	39		Stephanie Engelbrecht
18		Electronisounds	40		Jonathan Snipes (FX)
19		Fairburg	41		Campbell Kneale

2 Basic Operations

2.2 Power Up

NOTES

CHARGING / POWERING DELUGE

1. Connect the USB cable to Deluge and ensure it is connected to a powered USB device or the 9-12V (centre negative) external supply is connected. The power / USB led will illuminate to indicate power status.



- Red: battery is low, when operating on battery, and requires charging
- Yellow: unit is being charged and PSU / powered USB is connected
- Green: unit is fully charged. Battery lasts approx 6 hours from a full charge
- Off: when Deluge is switched on and is charged and operating from the internal battery source.

POWERING UP DELUGE

1. Ensure the device is charged or connected to a USB or external PSU.
2. Ensure the SD card is installed (pins / connectors facing up) using the SD card slot at the front of the unit.
3. Turn the unit on by switching the ON/OFF switch located at the rear of the device to ON.
4. Deluge will power up in 'clip view' with a blank song and one blank clip with an assigned synth preset '0' as shown on the display.
5. Although the sequence can be played the clips and song is blank at this stage.
6. The synth can be played manually using the right 'audition / section' pads where the notes are played chromatically (when SCALE is off) or by default C Major, 7 Note scale. The display will indicate the note as its played.

2.3 General Operating Controls

More in-depth details of the controls will come later. Some of the basic and fundamental controls are summarised here.

■ ADJUSTING THE MAIN VOLUME LEVEL

1. In any view, turn the (OUTPUT LEVEL) gold coloured rotary control.
2. This control adjusts the main output audio and headphone output levels. Care should be taken when adjusting as there is no display or indicator of the current level.

■ ADJUSTING THE TEMPO

1. In any view, turn the (TEMPO) black coloured rotary control.
2. Tempo changes in incremental BPM Steps. For finer resolution of +/-1 BPM press & turn (TEMPO) control.
3. The display will indicate the tempo change.

■ PLAYING AND STOPPING A SONG

1. In any view, press [PLAY] the button illuminates green when playing.
2. To stop the sequencer press [PLAY] while its running. The button will be unlit and the sequencer resets to the beginning when play is resumed.

2 Basic Operations

2.4 Views

NOTES

There are four main views which presents the user environment and toolkit for specific functions. Clip view concentrates on individual instruments, MIDI, CV, audio and their associated sequences. Song view is where a collection of clips are managed into a full song. Arranger enables the chaining of clips to develop a longer, linear arrangement. The fourth view is keyboard view, utilizing the grid as a live melodic instrument.

CLIP VIEW

Single synth, kit, audio, MIDI or CV clips configured as individual sequences, Clip view presents for example 1xsynth or 1xkit.

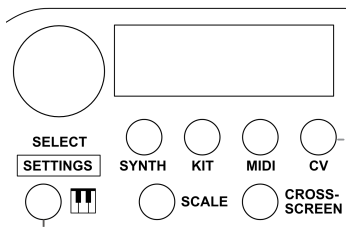

SYNTH CLIP VIEW

Synth button lit red

KIT CLIP VIEW

Kit button lit red

AUDIO CLIP VIEW

All buttons off / unlit

MIDI CLIP VIEW

MIDI button lit red

CV CLIP VIEW

CV button lit red

Instruments

External Gear

KEYBOARD VIEW

Enables playing melodic scales with the synth or for MIDI / CV.

SONG VIEW

Presents the overview of all clips collectively. Rows represent clips.



ARRANGER VIEW

Presents the view where clips can be chained together in series making a longer arrangement from the perspective of an instrument, MIDI, CV or audio track.

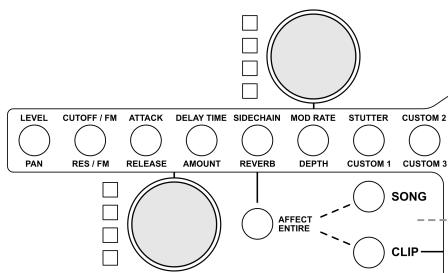

SONG VIEW

Song button lit blue

ARRANGER VIEW

Song button flashes blue

CLIP VIEW

Clip button lit blue

2.5 Synths and Kits

Deluge has the ability to sequence patterns arranged using kits or based on the synthesizer engine.

Synthesizer engine clips

- Deluge synth engine allows sound design by configuration of subtractive or FM synthesis, or the playback and manipulation of samples.
- Synth clips are typically used to create a melody for both lead and bass-style instruments.
- Notes are populated across the pad grid with the pitch affected by the up / down position on the grid rows.
- A colour is indicated for the notes on a synth clip and set by pitch. Colour can be edited.
- Synthesizer is selected by pressing the [SYNTH] button - lit red.
- Saving a synth preset only saves the synth setting data. No patterns are stored with synth presets.

Kit clips

- Kits consist of unique sounds per row. Typically based on samples but also may be synthesized sounds, or MIDI or CV outputs.
- While the obvious and common use of kits is to trigger drum sounds such as a kick or snare, longer loops and non-percussive samples can also be used within kits.
- Kit sounds are mapped across rows of the sequencer - each individual sound is represented on its own row.
- Each row of the clip is coloured independently. Colour can be edited.
- Kit is selected by pressing the [KIT] button - lit red.
- Saving a kit preset only saves the kit setting data and sample links. No patterns are stored with kit presets.

2 Basic Operations

2.6 Clip View: Overview

In clip view the pad grid is laid out with 16 x 8 physical pads which represents a piano roll style view. Clip view is the default mode which is available on start-up and is indicated by the blue lit [CLIP] button.

Grid Basics : Clip View

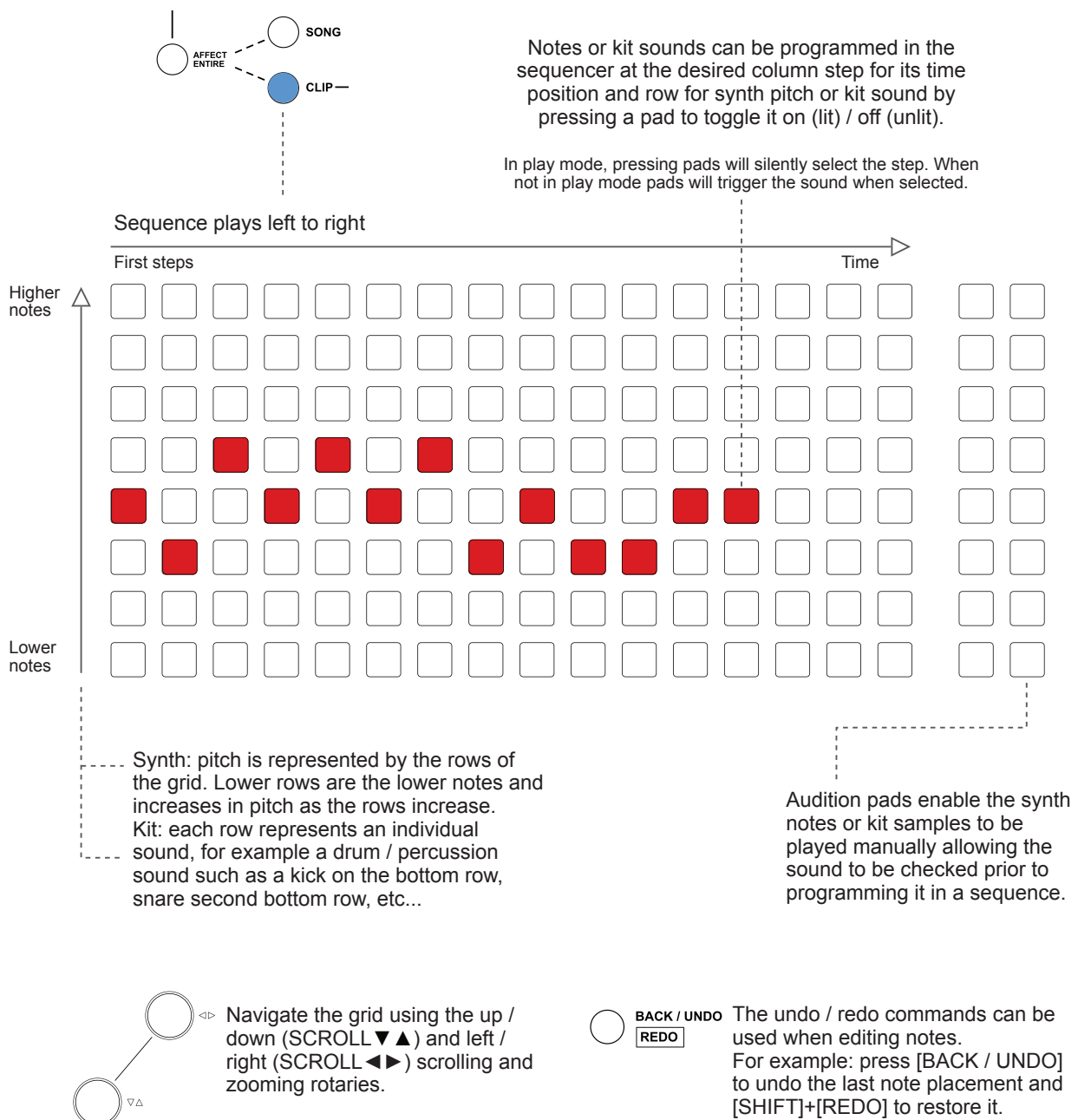

NOTES

Audition & Mute Pads : Clip View

Mute [MUTE] status is shown on the mute / launch pads located at the right of the Deluge interface.

The pads in the audition / section column are located far right of the Deluge interface and provide manual play out of sounds. Press [AUDITION] to trigger a sound. [SHIFT] + [AUDITION] to select a kit sound silently.

Unmuted rows / sounds can be heard and are indicated by a green illuminated pad button.

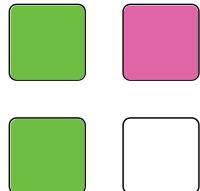

Synth root note may show two lit pad buttons if the full octave is in focus on the grid.

Muted rows / sounds are silent and are indicated by a yellow illuminated pad button.

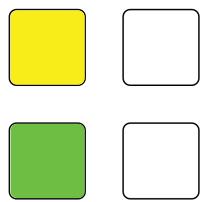

Kit sounds are selected by the row and hence only this row / sound is affected by parameter changes unless [AFFECT ENTIRE] is selected.

Pressing the mute pads toggle mute status on and off in clip view.



MUTE / LAUNCH AUDITION / SECTION

○ BACK / UNDO The undo / redo commands can be used when muting / unmuting. For example: press [BACK / UNDO] to undo the last mute command and [SHIFT]+[REDO] to restore it back

2 Basic Operations

SELECTING A SYNTH PRESET

1. Press [CLIP] to select clip view. This is indicated by the clip button illuminated blue.
2. Press [SYNTH] button to select synth. Synth button illuminates red.
3. Rotate the (SELECT) rotary control to select a synth preset. The selected preset is indicated by the number or name on the display.
4. Press an [AUDITION] pad to listen to the sound and the note played. This enables auditioning of the sounds for selection.
5. Once selected, the sound displayed will be ready for use on the current clip. Synth presets are only the instrument - not a pattern.

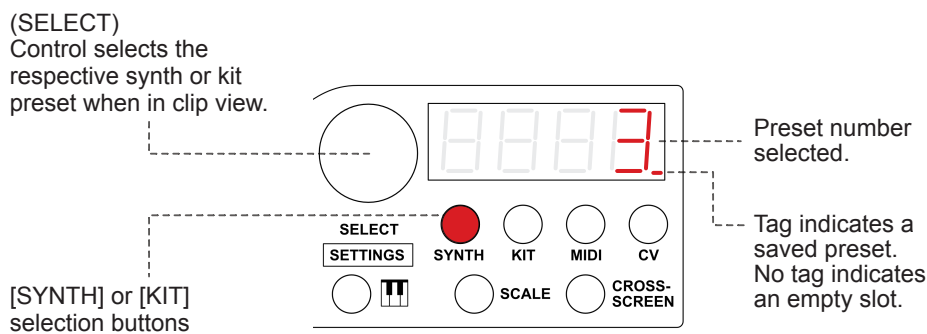

SELECTING A KIT PRESET

1. Press [CLIP] to select clip view. This is indicated by the clip button illuminated blue.
2. Press [KIT] button to select a kit. Kit button illuminates red.
3. Rotate the (SELECT) rotary control to select a kit preset. The selected preset is indicated by the number on the display.
4. Press an [AUDITION] pad up / down the pad row plays out each sound from the kit collection. This enables the auditioning of the individual sounds on each row prior to selection.
5. Once selected, the sound displayed will be ready for use on the current Clip. Kit presets are only the kit instrument and sounds / samples - not a pattern.

SELECTING A SYNTH PRESET WITH SELECTION MENU

1. Press [CLIP] to select clip view. This is indicated by the clip button illuminated blue.
2. Select synth by pressing [SYNTH] if not already selected. The synth button illuminates red.
3. Press [LOAD] + [SYNTH] to open the load menu.
4. The alphanumeric keyboard will appear to enable searching for a preset name or turn (SELECT) to choose a preset.
5. Press an [AUDITION] pad to listen to the sound and the note played. This enables auditioning of the sounds for selection.
6. Press [LOAD] to load the preset.
7. Once selected, the sound displayed will be ready for use on the current clip. Synth presets are only the instrument - not a pattern.

SELECTING A KIT PRESET

1. Press [CLIP] to select clip view. This is indicated by the clip button illuminated blue.
2. Press [KIT] button to select a kit. Kit button illuminates red.
3. Press [LOAD] + [KIT] to open the load menu.
4. The alphanumeric keyboard will appear to enable searching for a preset name or turn (SELECT) to choose a preset.
5. Press an [AUDITION] pad up / down the pad row plays out each sound from the kit collection. This enables the auditioning of the individual sounds on each row prior to selection.
6. Press [LOAD] to load the preset.
7. Once selected, the sound displayed will be ready for use on the current Clip. Kit presets are only the kit instrument and sounds / samples - not a pattern.

2 Basic Operations

SAVING A SYNTH PRESET IN CLIP VIEW / KEYBOARD VIEW

1. To save current preset sound, press [SAVE] + [SYNTH]. The buttons SAVE, SYNTH and BACK/UNDO plus the display will flash.
2. The display will indicate the next available iteration of patch number i.e patch 171, if patch 171 exists, Deluge will show 171A, then 171b etc. This avoids accidentally overwriting existing patches. Turning (SELECT) allows the option to select existing patch to overwrite.
3. The alphanumeric keyboard appears to allow a preset name to be entered.
4. Press [SAVE] button to confirm saving or press [BACK / UNDO] to cancel. A 'donE' message will be displayed when complete.
5. The patch is stored in the SYNTH folder on the SD card, named by the patch number selected i.e. for patch 171A: SYNT171A.XML.

SAVING A KIT PRESET IN CLIP VIEW

1. To save current kit, Press [SAVE] + [KIT]. The buttons SAVE, KIT and BACK/UNDO plus the display will flash.
2. The display will indicate the next available iteration of patch number i.e kit 0, if kit 0 exists, Deluge will show 0A, then 0b etc. This avoids accidentally overwriting existing patches. Turning (SELECT) allows the option to select an existing kit to overwrite.
3. The alphanumeric keyboard appears to allow a preset name to be entered.
4. Press [SAVE] button to confirm saving or press [BACK / UNDO] to cancel. A 'donE' message will be displayed when complete.
5. The kit is stored in the KIT folder on the SD card named by the kit number selected i.e. for kit 0A; KIT000A.XML.

Any new presets saved are available in the library for selection when loading. This means the numbering may vary from the listed factory library i.e. instead of the original kits 3, 4, 5, 6 for example the list may now read 2, 3, 4, 4A, 4b, 5, 6 as well as the manually named presets.

NOTES

■ CREATING A PRESET FOLDER

1. Press [CLIP] to select clip view. This is indicated by the clip button illuminated blue.
2. Press [SYNTH] or [KIT] button to select.
3. Press [SAVE] + [SYNTH] or [KIT] to open the save menu.
4. The alphanumeric keyboard will appear. Type a name of the folder to create.
5. Press and hold [SAVE] until 'CrEA' - Create appears.
6. Press [SAVE] to create the folder. This folder will be visible when loading and also will be available to save presets.
7. If required, type in the preset name or number to save or press [BACK/UNDO] to exit.

2 Basic Operations

2.7 Transferring Presets Between Deluge Devices

NOTES

Presets can be transferred between devices when the preset has been packaged in the correct format for Deluge to import. This needs to be setup manually as there is no automated preset export function. Part of this function would be performed on a PC or Mac on the SD card folders.

■ TRANSFERRING PRESETS (SD CARD TO SD CARD)

1. Insert the source SD card into the PC/Mac card reader.
2. The preset XML file to export should be identified on the SD card. This can be copied to a folder on the PC / Mac. For example a kit preset found in the KITS folder and filename breakbeat.xml.
3. Identify any audio files that are associated with the preset. These should be also copied to the PC/Mac within a sub-folder with the same name as the XML file. For example name the sub-folder 'breakbeat'.
4. Eject the source SD card from the PC/Mac card reader and insert the destination SD Card.
5. Copy the XML file from the PC/Mac folder into the appropriate folder on the destination SD. For example into the KITS folder.
6. Copy the folder named after the XML and which contains the audio from the PC/Mac to the SD Card. Copy this folder to the same location, next to the XML file.
7. Insert the SD card into Deluge.
8. Deluge will identify the audio files when loading the 'imported' the preset. The imported preset can be then saved.

Any imported presets will be retained in their original audio folder location and are not transferred elsewhere when saving the preset or a song containing it. This means the original folder should always be retained and not changed for the preset to be functional.

2.8 Clip View: Parameter Affect Group Changes

In clip view some quick access sound / synth parameters are immediately available and can be adjusted using the 'parameter affect' controls. These are quickly accessible using the two gold rotary controls and associated buttons and enable changes of parameters on the currently selected sound, whether synth or kit.

Parameter Affect Group : Clip View

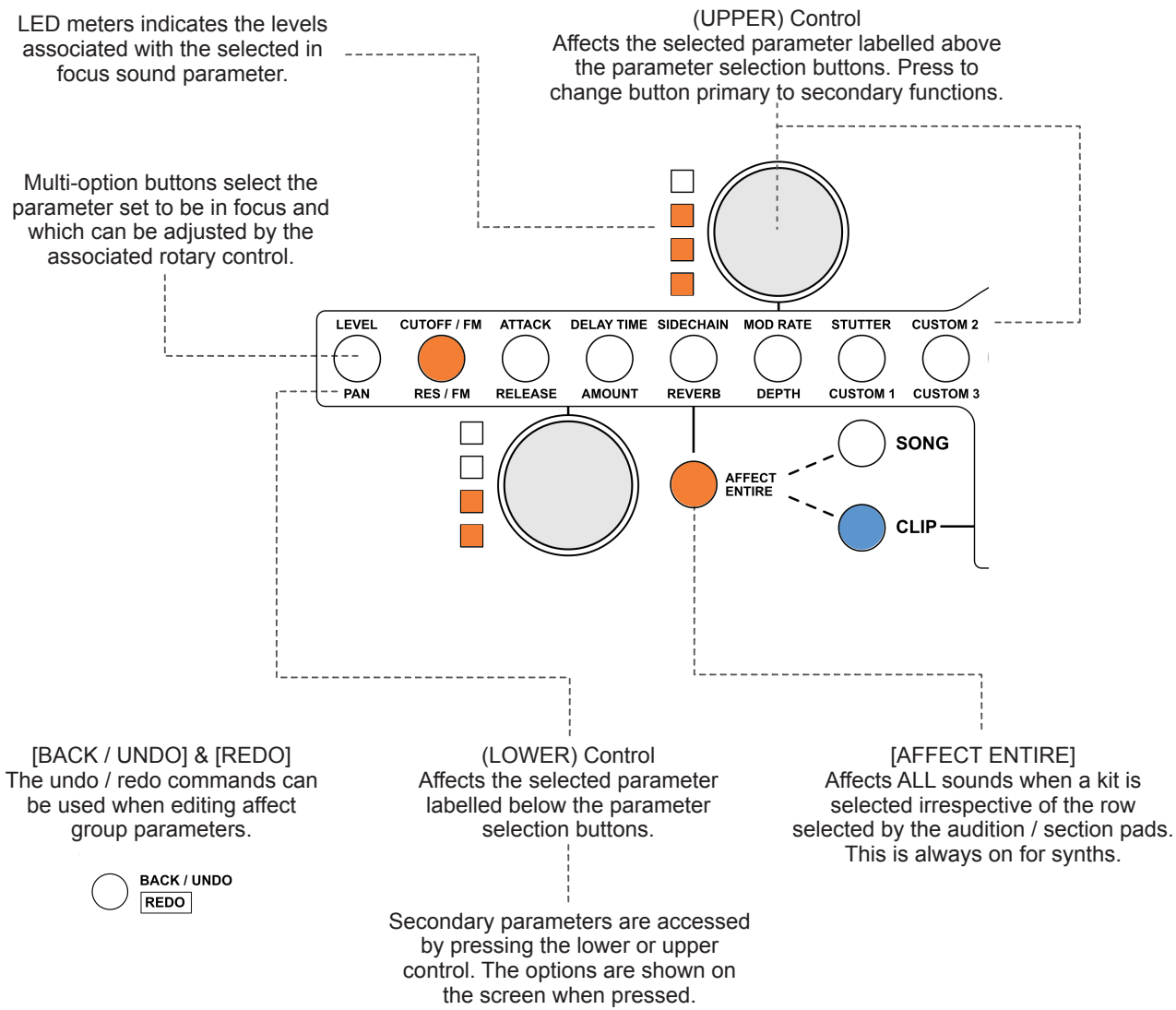

Custom 1, 2, and 3 are mapped based on the preset chosen. These custom controls can mapped to other settings. Labels therefore on the control buttons are defaults only. Parameters can be remapped to the 8 controls, mapped for external MIDI control or existing settings edited by using the sound editor.

2 Basic Operations

NOTES

Parameter Affect Group Reference : Clip View

Button + Upper / Lower	Primary Parameter Function	Secondary & Other Parameter Functions Press [UPPER] [LOWER] Control
B1 Upper	Volume Sound Level adjustment	
B1 Lower	Pan Panning of the sound	
B2 Upper	Cutoff / FM Cutoff frequency of the selected filter. In FM Mode Modulator 1 amount	Selects which filter is affected by the control LPF is default, HPF or EQ for Bass/Treble amount
B2 Lower	Res / FM. Filter Resonance In FM Mode Modulator 2 amount	Selects the filter slope for the LPF between 12dB / Octave, 24dB/Octave or Analog modelled DRIVE Filter (24dB/Oct +Saturation).
B3 Upper	Attack Env 1 Envelope Attack Time	
B3 Lower	Release Env 1 Envelope Release Time	
B4 Upper	Delay Time Effect delay time	Selects Ping-Pong style delay On (Ping) or Off (norm)
B4 Lower	Amount: amount of delay applied to the sound.	Selects Analog (AnA) or Digital (diGi) delay simulation. Analog is high in CPU Usage and will lower the voice count if necessary.
B5 Upper	Sidechain	Selects the synchronisation for fast speed with 32 nd notes or slow speed with 8 th notes.
B5 Lower	Reverb	Selects the song applicable reverb preset between 'Small' (SnAL), 'Medium' (nEdi) and 'Large' (LArG)
B6 Upper	Mod Rate Modulation rate	Only used when in 'Affect Entire' mode for songs and kit clips where Mod rate and depth are controlling a modulation effect i.e. chorus, flanger or phaser. This selects the next in the list
B6 Lower	Depth Modulation depth	Only used when in 'Affect Entire' mode for songs and kit clips where mod rate and depth are controlling a modulation effect i.e. chorus, flanger or phaser. This selects the control between depth, feedback and offset depending upon the active effect.
B7 Upper	Stutter:	Enacts the stutter effect when pressed and stops when released. Length and speed are controlled by turning the control. Speed stutter loop up by pressing and turning the control.
B7 Lower	Custom 1	Configurable. Typical synth presets set to portamento and pitch for sample based sounds
B8 Upper	Custom 2	Configurable. Typical kit presets set to decimation When Osc1 is set as a wavetable synth, Custom 2 is set to control the wave position
B8 Lower	Custom 3	Configurable. Typical kit presets set to bitcrush When Osc1 is set as a wavetable synth, Custom 3 is LFO2 modulation depth of wave position. When Osc2 is set as a wavetable synth, Custom 3 is set to control the wave position.

NOTES

ADJUSTING A PARAMETER IN THE AFFECT GROUP

1. Press [CLIP] to select clip view This is indicated by the clip button illuminated blue.
2. Selected SYNTH or KIT by pressing [SYNTH] or [KIT]. The selected button illuminates red.
3. Audition the synth or kit sound manually with the [AUDITION] Pads. This enables adjustments to be heard and for kits selects the target sound to edit.
4. To adjust parameters for ALL kit sounds select [AFFECT ENTIRE] which will be lit orange when selected. This is automatically selected to on for Synths as technically there is only one sound.
5. Select the affect group parameter to change. For example envelope 1 'attack' time. This is button 3 from left and the parameter is labelled above the button. The button will be lit orange.
6. Adjusting the (UPPER) will adjust the attack time. The LED meter indicates the level / position of the parameter setting within its range.
7. The (LOWER) will affect the 'release' of envelope 1 as the button selections are for two default set parameters.
8. Continue to audition the sound as changes are made or play a sequence to hear adjustments during playback.
9. The preset will automatically change to a new sub slot number when saving after a parameter is adjusted e.g. from 52 to 52A to enable saving without overwriting the original if required.

2 Basic Operations

2.9 Alphanumeric Keyboard & Grid Layout.

NOTES

Deluge has an alphanumeric keyboard function within the 16x8 pad grid. This enables text entry for naming of songs, clips, etc. The default setting is QWERTY mode (can be changed in settings) and the keyboard is highlighted on the grid and available automatically when text entry options are available such as when saving, file browser, etc. Tapping a pad when loading or saving will bring the keyboard into view and automatic predictive text entry is provided based on Deluge analysing existing file names.

 (SCROLL ◀▶)
 Navigate left & right to move
 cursor across the display position.

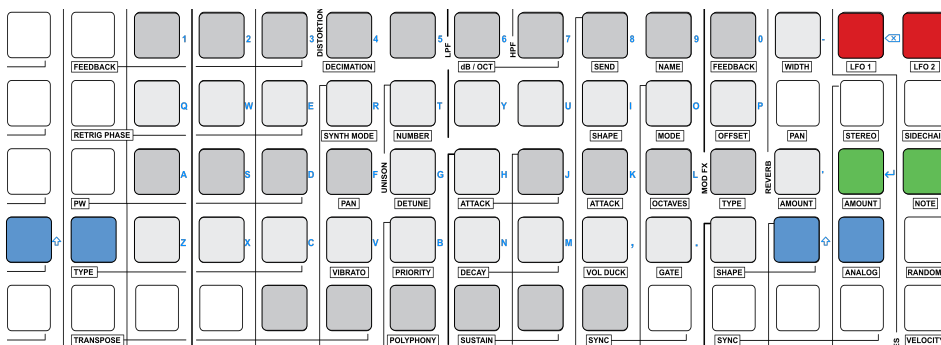

The shift, enter, backspace buttons are coloured and double up on pads for the function. Spacebar is the bottom row of 6 pads. Once the name has been typed in it is confirmed / saved by pressing 'RETURN' i.e. 'amount' or 'note' pads lit green.

[SHIFT] or [AUDITION] + [NAME] to rename a sound selected within a kit.

[AUDITION] + [NAME] to rename a track in arranger view.

NOTES

SETTING THE ALPHANUMERIC KEYPAD STYLE

1. Press [SHIFT] + press (SELECT) to open the settings menu.
2. Turn (SELECT) to choose the 'PADs' - pads option in-focus.
3. Press (SELECT) to drill into the sub-menu.
4. Turn (SELECT) to choose 'KEYb' - keyboard in-focus.
5. Press (SELECT) when 'KEYb' is in-focus.
6. Turn (SELECT) to choose the desired keyboard style from.
 - qwEr - QWERTY - Default to match grid layout.
 - AZEr - AZERTY
 - qrtZ - QWERTZ

SETTING THE SHORTCUT VERSION PAD LAYOUT

1. Press [SHIFT] + press (SELECT) to open the settings menu.
2. Turn (SELECT) to choose the 'PadS' - pads option in focus.
3. Press (SELECT) to drill into the sub-menu.
4. Turn (SELECT) to choose 'SHor' - shortcuts.
5. Press (SELECT) when 'SHor' is in-focus.
6. Turn (SELECT) to choose the desired shortcut style based on the firmware versions.
 - 3.0
 - 1.0

———— SEQUENCING ————

3 Sequencer

3.1 Sequencing Workflow

NOTES

An example of high level workflow on setting up a sequence.

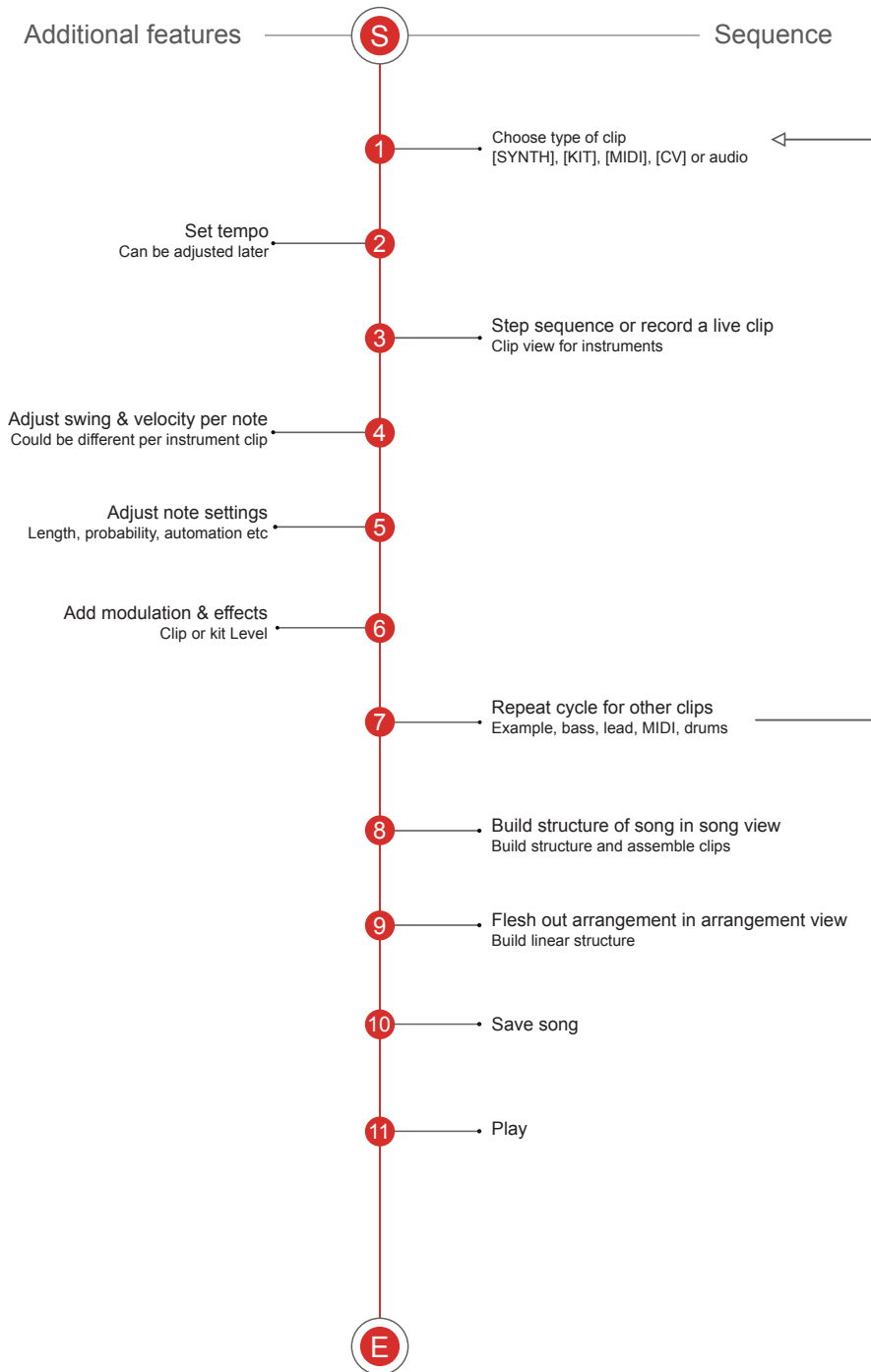

3.2 Playing a Sequence

Playing the sequence is a simple process using the mode group transport controls. The default direction is forwards, but reverse and ping-pong are also available as selectable options.

PLAYING A SEQUENCE

1. Press [CLIP] to select clip view. This is indicated by the clip button illuminated blue.
2. Press [PLAY] to start playback. Button is lit green. Press [PLAY] again to stop the sequence. Button is off.
3. Press (SCROLL ◀▶) + Press [PLAY] to start playback from the beginning of the grid / zoom position that is in focus instead of from the sequence start position.



PLAY

Press [PLAY]
To start sequencer playback.
Button illuminates green.



RECORD

RESAMPLE

Press [PLAY]
A second time to stop playback.
Button is unlit / off.



SHIFT

When playing the white column cursor will move left to right across the time range and can be seen in the respective pad grids.

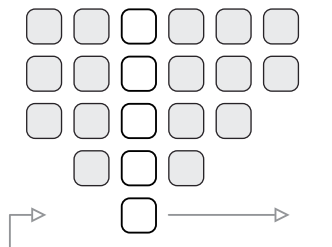

Press & hold (SCROLL ◀▶) + press [PLAY] to start the sequencer playback from the start of the current in focus grid scroll position instead of starting at the start of the full grid.

3 Sequencer

SETTING THE SEQUENCER PLAY DIRECTION

1. Press [CLIP] to select clip view. This is indicated by the clip button illuminated blue. For a KIT clip*, select the row, press [AUDITION].
2. Press [SHIFT] + [DIRECTION] to open the setup menu options. The button will flash and the display will indicate the current play direction. The default is FORWARD.
3. Turn (SELECT) to choose the desired direction from the three available options.
 - FORWARD. Will play the sequencer from the start - left to right. This is the normally expected playback behaviour.
 - REVERSE. Will play the sequencer in reverse where the start will be the end of the sequence - right to left.
 - PINGpong. Will play the sequencer firstly from the start - left to right, then at the end will reverse back right to left.
 - NONE. Only available for KIT rows* when AFFECT ENTIRE is OFF. This sets the current row direction to operate based on the global kit clip direction setting.
4. Once the direction is selected, press [PLAY] to start playback. Button is lit green. Press [PLAY] again to stop the sequence. Button is off.

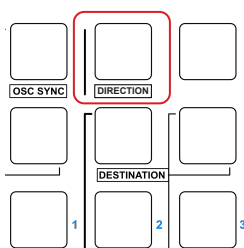

Note: The 'direction' shortcut button label may not be printed on faceplates.

*Note: Kit rows can be set to have independent direction control settings. Independent direction for rows are set in a KIT and when [AFFECT ENTIRE] is set to OFF. To set the global direction for all rows in a kit clip, set the direction setting while the [AFFECT ENTIRE] option is set to ON. This will therefore apply the direction to all rows.

NOTES

Play direction.

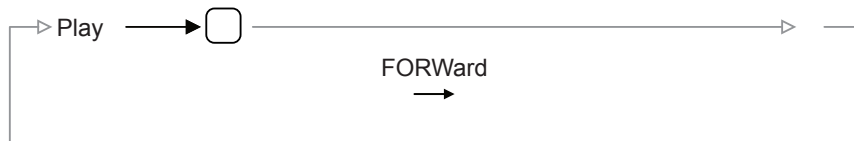
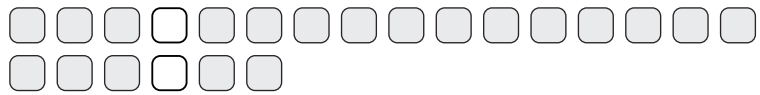

Plays from the start to end of length and then loops back to the start



Plays from the end to the start i.e. in reverse and then loops back to the end

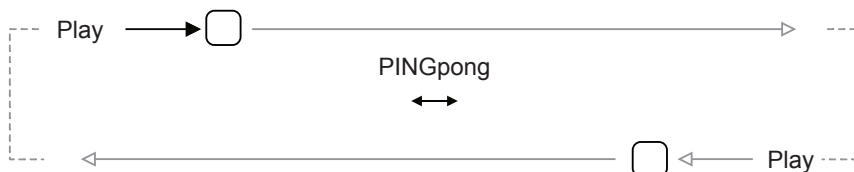

Plays from the start to the end, then back to the start and loops in this pattern

3 Sequencer

3.3 Tempo & Swing

NOTES

Tempo can be set manually or a tap tempo option is available.

MANUALLY SETTING THE TEMPO

1. Turn (TEMPO) control to adjust the BPM. Higher increments of change will occur at higher BPM settings than when changing lower BPM settings.
2. For 1 BPM increments, press + turn (TEMPO) to adjust the BPM.
3. The display will show tempo settings when adjustments are being made. Press (TEMPO) to quickly check the current setting.

SETTING THE TEMPO USING TAP TEMPO

1. Tap the [TAP TEMPO] button two or more taps. The button will flash green while tapping.
2. Tempo will adjust automatically and more accurately as more taps are captured.
3. The display will show tempo settings when tapping.

SWITCHING THE METRONOME ON/OFF

1. Press [SHIFT] + [TAP TEMPO] button. The button will illuminate green to signify that the metronome is turned on.
2. The metronome will sound out when the sequence is in play and running. A higher pitch at each bar start and lower pitch on the beat.
3. (OUTPUT LEVEL) will adjust the entire volume output and headphone output. This will also affect the metronome volume.
4. Press [SHIFT] + [TAP TEMPO] button when metronome is on to turn it off. The button will be unlit to signify that the metronome is turned off.

ADJUSTING SWING

1. Press [SHIFT] + turn (TEMPO) button. A swing % value between 1-99 can be dialled in to adjust the swing and shift.

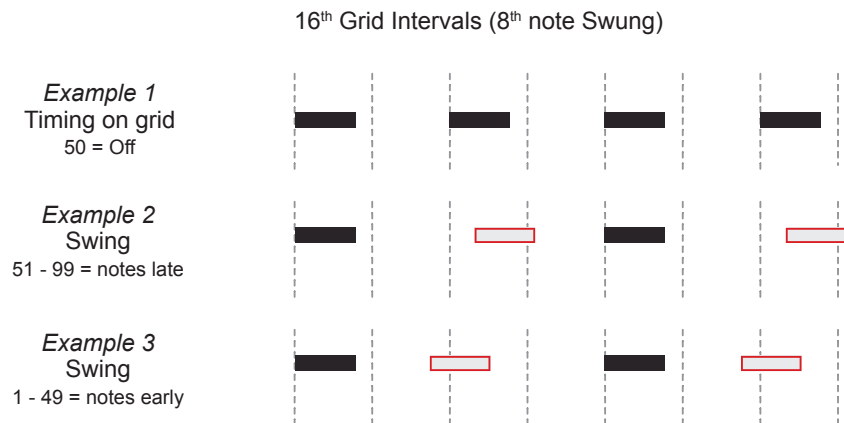

Swing feature provides a rhythmic adjustment that brings a more natural and organic feel to songs and operates generically and not at an individual note level.

ADJUSTING THE SWING INTERVAL SETTING

1. Open the settings menu by pressing [SHIFT] + press (SELECT).
2. Turn the (SELECT) control to navigate the menu top level and select 'SWING' in-focus.
3. Press (SELECT) to drill to the swing sub-menu.
4. Turn (SELECT) to choose between 4 bar, 2 bar, 1 bar, 2nd, 4th, 8th, 16th, 32nd, 64th note intervals. 16th is the default setting.
5. Press [BACK / UNDO] to back out of the menu when the parameter has been changed or at any time in the menu to back up.
6. The swing interval setting is saved as part of a song. New songs revert to default while saved and reloaded songs will retain the swing interval setting.

3 Sequencer

3.4 Recording Pattern Sequences

NOTES

The recording of note events can be performed manually using the step sequencer or live recording using the audition pads.

STEP RECORDING A BASIC SYNTH / MIDI / CV PATTERN

1. Press [CLIP] to select clip view. Clip button illuminated blue.
2. Select SYNTH by pressing [SYNTH] if not already selected. The synth button illuminates red. Also applies to MIDI & CV.
3. Select a preset for a synth or channel for MIDI & CV by turning the (SELECT) rotary. Auditioning the synth selections is available with the [AUDITION] pads which plays the scale.
4. Program a pattern on the grid by pressing one or more [PAD] buttons. The arrangement is made across columns for the time line from left to right. The note pitch is dependant on the row selected.
5. To extend the note length hold the first [PAD] + press end [PAD] which will extend the note between the two pads. The first pad is lit with the additional pads of the note dimly lit. Repeat to deselect.
6. The grid by default is in 1/16th Note intervals across 1 bar of the physical horizontal grid. The [PAD] buttons lit will trigger the synth when the sequence is playing. The actual grid environment can be bigger than just the physical 16 x 8 pads and therefore may be out of view.
7. Press [PLAY] to play out the synth sequence and observe the white cursor bar scrolling left to right and cycling across the grid.
8. Patterns can be edited during playback.
 - Press an unlit [PAD] to select it and press a lit [PAD] to deselect it.
 - Press [BACK / UNDO] to undo a note step placement action and [SHIFT] + [BACK / UNDO] to restore, redo the note step action
 - Use the mute / launch column to mute (yellow) or unmute (green) a selected row's notes from the pattern.
 - Saving synth presets in clip view will only save the synth settings. Patterns are stored with songs not in synth presets.
 - The lit audition / section pad indicates the root note by the lit button or buttons if a full octave is in view.
 - The colours will change dependant upon the pitch by row

STEP RECORDING A BASIC KIT PATTERN

1. Press [CLIP] to select clip view. This is indicated by the clip button illuminated blue.
2. Selected kit by pressing [KIT] if not already selected. The kit button illuminates red.
3. Select a preset by turning the (SELECT) rotary and auditioning the individual sound selections available with the [AUDITION] Pads.
4. Program a pattern on the grid by pressing one or more [PAD] buttons. The arrangement is made across columns for the time line from left to right. The individual sounds i.e. drum hits are dependant on the rows selected.
5. The grid by default is in 1/16th intervals across 1 bar of the physical horizontal grid. The [PAD] buttons lit will trigger the kit sounds when the sequence is playing. The actual grid can be bigger than just the 16 x 8 pads and therefore may be out of view.
6. Press [PLAY] to play out the kit sequence and observe the white cursor bar scrolling left to right and cycling across the grid.
7. Patterns can be edited during playback.
 - Press an unlit [PAD] to select it and press a lit [PAD] to deselect it from the pattern.
 - Press [BACK / UNDO] to undo a kit step placement action and [SHIFT] + [BACK / UNDO] to restore, redo the kit step action.
 - Use the mute / launch column to mute (yellow) or unmute (green) a selected row's notes from the pattern.
 - Saving kit presets in clip view will only save the kit settings. Patterns are not stored in kit presets, they are stored with songs.
 - The lit audition / section pad indicates the selected row and hence the selected kit sound.
 - Colours are assigned to the unique kit sound on each row.

3 Sequencer

LIVE RECORDING A BASIC PATTERN USING AUDITION PADS

1. Press [CLIP] to select clip view. This is indicated by the clip button illuminated blue.
2. Selected SYNTH or KIT by pressing [SYNTH] or [KIT] if not already selected. The synth or kit button illuminates red.
3. Press [RECORD] to put the sequencer into armed record mode ready for play. Record button is lit red.
4. Press [PLAY] to start the sequencer playing. Play is lit green.
 - Fixed length mode. If notes exist in the clip a white cursor will play. The notes are recorded for the length set, eg: 1 bar.
 - Auto extend mode: If the clip is fully empty, no notes or sounds on the grid, the cursor will play red. Notes will be recorded as the sequencer records with an 'unlimited' length.
5. Play the notes, chords, melody in real time using the 8 [AUDITION] pads. The pattern will be recorded as played including a predefined velocity, timing, length and note. Notes are displayed for each of the audition pads when played.
6. Press [PLAY] to stop playing the sequencer. Press [RECORD] to deselect record mode.
7. Overdubs can be created by repeating step 3 - 6.
8. Patterns can be edited during playback.
 - Default quantization for recording live is 32nd notes. Quantization sets how accurately the notes are placed onto the grid
 - Press an unlit [PAD] to select it and press a lit [PAD] to deselect it.
 - Press [BACK / UNDO] to undo phases of the recording and [SHIFT] + [BACK / UNDO] to restore, redo the recording.
 - Use the mute / launch column to mute (yellow) or unmute (green) a selected row's notes from the pattern.
 - The lit audition / section pad indicates the root note by the lit button or buttons if a full octave is in view for synths. Lit pad for kits indicates a selected row.
 - The colours will change dependant upon the pitch by row.

LIVE RECORDING A BASIC SYNTH PATTERN USING KEYBOARD

1. Press [CLIP] to select clip view. This is indicated by the clip button illuminated blue.
2. Select SYNTH by pressing [SYNTH] if not already selected. The synth button illuminates red. Keyboard view is not available for kits.
3. Press [KEYBOARD] to select keyboard view. Pads illuminate to represent keyboard scale to be played. Semitones horizontally and rows represent 4th intervals per row. This is similar to a guitar fret-board.
4. Press [RECORD] to 'arm' the sequencer in record mode ready for a play request. Record button is lit red.
5. Press [PLAY] to start the sequencer playing. Play is lit green and the red grid cursor steps through the sequence on the top row.
 - Fixed length mode. If notes exist in the clip a white cursor will play. The notes are recorded for the length set, example 1 bar.
 - Auto extend mode: If the clip is fully empty, no notes or sounds on the grid, the cursor will play red. Notes will be recorded as the sequencer records with an 'unlimited' length.
6. Play the grid keyboard [PAD] lit notes, chords, melody in real time. The pattern will be recorded as played including predefined velocity, timing, length and note. Notes are displayed for each of the keyboard pads when played.
7. Press [PLAY] to stop playing the sequencer. Press [RECORD] to deselect record mode.
8. Overdubs can be created by repeating step 4 - 7
9. Patterns can be edited during playback.
 - Default quantization for recording live is 32nd notes. Quantization sets how accurately the notes are placed onto the grid
 - Scale for the keyboard can be changed.
 - Press [BACK / UNDO] to undo phases of the recording and [SHIFT] + [BACK / UNDO] to restore, redo the recording.
 - The lit [PAD] indicates the root note by the brightest button.

3 Sequencer

■ SETTING A RECORDING COUNT-IN

1. Press [SHIFT] + press (SELECT) to access the settings menu.
2. Turn (SELECT) to highlight 'rECo' - recording, in-focus.
3. Press (SELECT) to open the sub-menu.
4. Turn (SELECT) to highlight 'CoUn' - count-in, in-focus.
5. Press (SELECT) to set the count-in option.
6. Turn (SELECT) to choose 'oFF' or 'oN'. This will set the count-in for recording on or off.
7. Count in will operate when set ON;-
 - With Deluge as leader, [RECORD] enabled, press [PLAY] to perform a count-in prior to recording.
 - Metronome and display counts down 4-3-2-1 prior to recording.
 - Count-in is disabled if recording is going to begin for just one audio clip from which it's going to auto-detect the tempo.

3.5 Note Characteristics

Several basic characteristics of notes can be changed in settings. These include, velocity, note repeat, note length, quantization and note scales. Some of these can be edited in the sequencer.

CHANGING A RECORDED SYNTH NOTE VELOCITY

1. After a pattern has been recorded, notes will be at a default velocity level.
2. Press & hold one or more [*PAD*]'s for the note to change and turn (SCROLL ◀▶).
3. The system default velocity is 64, however the velocity used on the last note entry / edited will be applied to the next note entered.
4. Velocity will be displayed and its value.

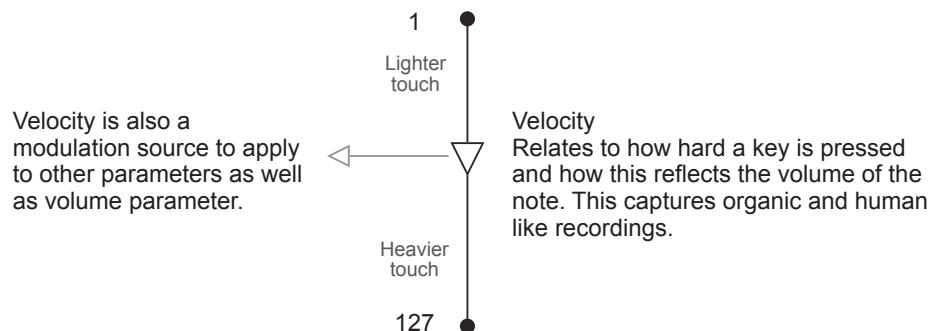

Deluge pads are not velocity sensitive. The default velocity is 64 but this default level can be changed in the settings options under the defaults menu.

SETTING A NOTE TO REPEAT

1. After a pattern has been recorded, notes will be trigger individually
2. Hold [*PAD*] + Press & turn (SCROLL ▼▲). [*PAD*] is the note to repeat.
3. The value selected will determine the number of repeats to assign to the selected note, positioned equally in the time interval of the pad.

3 Sequencer

CHANGING THE DEFAULT RECORDING QUANTIZATION

Quantization sets the accuracy and resolution of how close to the grid intervals notes are placed.

1. Open the settings menu by pressing [SHIFT] + press (SELECT).
2. Turn the (SELECT) control to navigate the menu to select 'rECo'.
3. Press (SELECT) to drill down the recording menu.
4. Turn the (SELECT) control to navigate the menu and select 'qUAn' - QUANTization in focus.
5. Press (SELECT) to drill to the Quantization settings.
6. Turn (SELECT) to choose between off (384th), 4 bar, 2 bar, 1 bar, 2nd, 4th, 8th, 16th, 32nd and 64th note intervals. A value of 32nd is the default setting.
7. Press [BACK / UNDO] to back out of the menu when the parameter has been changed or at any time in the menu to back up.
8. The quantization chosen will ensure tight alignment on the grid based on the time interval chosen when recording live.

CLEARING CLIP NOTES

1. Press (SCROLL ◀▶) + [BACK / UNDO].
2. Display shows 'CLEAR'. Notes and their associated automation will be cleared from the clip, including notes outside of the grid view.

TRIPLET VIEW

1. Press [TRIPLETS VIEW] to select. The button will be illuminated blue.
2. The grid will change to reflect triplets view by showing columns of 3 rather than 4 as is normal.
 - The unused 4th column is blanked out and is shown by a grey dull colour when showing 16th notes.
 - Zooming will carry over the triplets view in the original time division.
 - To set triplets view in a different time division, exit triplets view, change the grid time division and return to triplets view.
 - A triplet in musical terms would mean 3 notes play for the same time division as 4.
3. Program note sequence as desired.
4. Press [TRIPLETS VIEW] to exit. Button is unlit and the grid view changes back to normal.

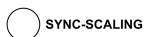

[TRIPLETS VIEW]
Switches the grid to triplets view, laying out the grid with 3 of 4 columns in the time division. The three notes have the same time period as the original 4.

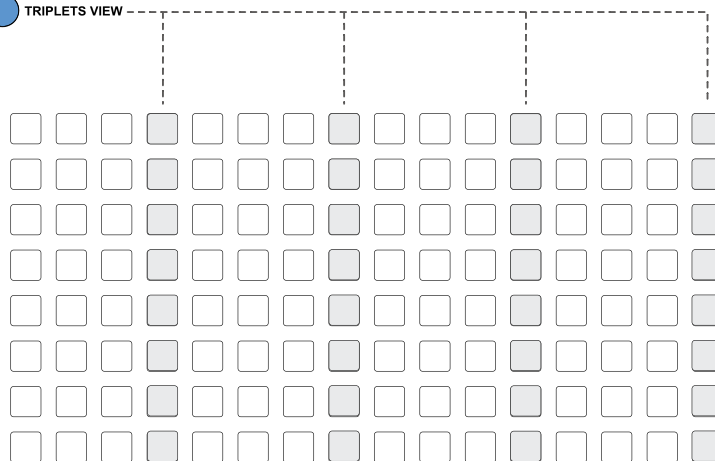

3 Sequencer

EDITING NOTES' LENGTH

1. Note lengths can be set when entering clip notes by pressing the note START [PAD] + END [PAD] on the same row. For kits, samples will automatically map across the pads matching the sample length.

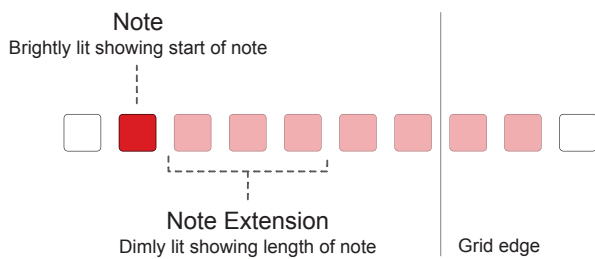

2. Reduce the note length by pressing one of the extension [PAD]'s to shorten it.
3. To extend a note across grid views:-
 - Press the [PAD] for the note start.
 - Scroll to the next grid view 'page' using (SCROLL ◀▶). This would be further in time from the original note.
 - On the same row, press (SCROLL ◀▶) + [PAD] at the end position.
 - The note will be extended across the 'page'.
4. To create a note for the duration of the clip, for example as a pad or to create a 'drone' note:-
 - Press the [PAD] for the note start on the first column (left position) of the clip.
 - On the same row, press (SCROLL ◀▶) + [PAD] at the last column (right position).
 - The note will be extended across the full clip.
 - Deluge will ensure that these type of notes play continuously through the clip and will loop. This is handled as a special case and the note does not restart.

ADJUSTING A CLIPS HORIZONTAL NOTE EVENT POSITION

1. Press (SCROLL ▼ ▲) + Turn (SCROLL ◀ ▶) control to adjust the clip note events i.e. notes and automation horizontally across the grid.
 - The note events will move 1 step incrementally across the horizontal grid. The steps are based on the zoom level.
 - Note events which scroll off the edge left or right will wrap back onto the grid from the opposite side.

NUDGING INDIVIDUAL NOTES HORIZONTALLY

1. Hold [*Pad*] + Press and turn (SCROLL ◀ ▶) to nudge the selected [*Pad*] note event forward or backwards, indicated by +/- values.
2. This will nudge at the song's minimum resolution, default is 384th notes.

COPYING / PASTING NOTE RANGE

1. Press [LEARN / INPUT] + press (SCROLL ◀ ▶) to copy the clips notes.
 - This will copy the step range of notes in the current view on the grid at the current scroll and zoom position.
 - The time range of notes is what is copied including all notes out of view above and below the pad range.
 - Copy can be performed from one clip to another in the same or different songs as well as within the same clip.
2. Select the new location for pasting the previously copied range. For example extend the clip length or scroll to another part of the clip.
3. Press [SHIFT] + [LEARN / INPUT] + press (SCROLL ◀ ▶) to paste the current clips notes:
 - When pasting, the notes are pasted into the current view.
 - If the destination view is transposed from the original copied location the notes are pasted into the new transposed position.
 - If only a part of the grid is selected as the destination, the notes for the available columns are pasted and the rest discarded.
 - Notes will be pasted into any new zoom levels where notes will be stretched or reduced to meet the destination zoom view.

3 Sequencer

3.6 Note Scales

Scale mode is automatically set when new synth, MIDI and CV clips are created. Scale mode will lock the notes to a specific scale, by default a major scale. Chromatic scale can be selected by exiting 'scale' mode. Other scales can be selected.

Example: Start-Up in Major Scale, C Root Note

[SCALE] ON
Scale is locked to a major scale. After adding notes when selecting scale mode, a guess of the scale and root note / key is made by Deluge.

[SHIFT] + [SCALE]
Switches the scale through seven western music scales of Major, Minor, Dorian, Phrygian, Lydian, Mixolydian and Locrian. CANT may be displayed if there are more than seven notes programmed into the sequence.

[SCALE] OFF
Chromatic scale with notes and rows being one semitone apart. Scale is displayed.

[SCROLL ▼▲]
Navigate the rows using up / down scroll. Grid is 8 pad rows high and the full range is out of view.

MAJOR SCALE (Default)
Sharps shown with a period.

CHROMATIC SCALE - 12 Notes - Rows in Semitones

OCTAVE / Chosen Scale - 7 Notes

AUDITION / SECTION

Available Scales in Scale Mode

MAJOR MINOR DORIAN PHRYGIAN LYDIAN MIXOLYDIAN LOCRIAN

	MAJOR (Ionian)	MINOR (Aeolian)	DORIAN	PHRYGIAN	LYDIAN	MIXOLYDIAN	LOCRIAN
	C4	C4	C4	C4	C4	C4	C4
	b3	A.3	A.3	A.3	b3	A.3	A.3
	A3	G.3	A3	G.3	A3	A3	G.3
	G3	G3	G3	G3	G3	G3	F.3
	F3	F3	F3	F3	F.3	F3	F3
	E3	d.3	d.3	d.3	E3	E3	d.3
	d3	d3	d3	C.3	d3	d3	C.3
	C3	C3	C3	C3	C3	C3	C3

Western 7 Note Scales. Example - C Scale. Sharp notes indicated with a period (.)

OTHER

User defined custom scales can be created by selecting the notes and entering [SCALE] mode and Deluge will define a custom scale shown as OTHER.

SELECTING SCALE MODE

1. Press [SCALE] to switch scale mode ON. Button lit blue.
2. Press [SCALE] a second time to switch it OFF. Button unlit.

DELUGE ANALYSIS AND SELECTION OF NOTE SCALE

1. With notes programmed into the sequence grid.
2. Press [SCALE] to switch it ON. Button illuminates blue. Cycle it off and on if already selected to ON.
3. Deluge will evaluate the notes and establish a 'best fit' scale for the selected notes as well as the scale root note.
4. The selected scale will be displayed flashing for a few seconds when selecting [SCALE].

3 Sequencer

MANUALLY SETTING A ROOT NOTE

1. With notes programmed into the sequence grid.
2. Press [SCALE] + [AUDITION] pad for the desired root note. The audition pads can be played to display the notes assigned to each pad.

MANUALLY CHANGING SCALE

1. Press [SHIFT] + [SCALE] to cycle through the seven available scales.
2. The grid pattern will change with notes moving to the correct note row for the selected scale.

TRANSPOSING A CLIP UP OR DOWN

1. Press & turn [SCROLL ▼ ▲] to transpose the whole octave.
2. Press [SHIFT] + press & turn [SCROLL ▼ ▲] to transpose by semitone increments.
 - ALL clips that are in SCALE mode will be transposed by the same semitone increment when adjusting the transposition

All songs with multiple clips set to SCALE mode will always be locked to the same scale. Changes in scale settings on one clip will affect all others in scale mode. This also includes Deluge analysis and evaluation of scale algorithm when entering scale mode, where all clip notes will be evaluated. This may lead to notes being added / changes in the clips when editing scales.

■ CREATING A CUSTOM SCALE

1. Exit scale mode by pressing [SCALE]. Button should be unlit.
2. Select the notes on the grid that will be attributed to the new scale.
3. Press [SCALE], Deluge will evaluate the notes and establish a best fit scale. Button will illuminate blue.
4. If notes selected form an existing scale this will be recognised. If the notes don't form one of the seven Deluge scales a custom scale identified on the display as OTHER will be created.
5. Other scales for the notes would indicate 'CANT' on the display if attempted to be selected when the notes don't fit.

■ MANUAL SHARPENING / FLATTENING NOTES IN CUSTOM SCALES

1. Ensure [SCALE] mode is on.
2. For the selected note / row, press & hold [AUDITION] pad + press & turn (SELECT) to sharpen or flatten the note.
 - Sharp notes are displayed with a period i.e. E.3 as opposed to no period E3.
 - Note will play when pressed. To adjust silently, use [SHIFT] with the [AUDITION] pad.
 - [SCALE] will flash quickly if changes attempted are not available. For example making a sharp the same as the next note / row.

3 Sequencer

3.7 Keyboard View & Chords

Deluge has a keyboard view which is reflective of the scale and is mapped to the 16 x 8 pad grid. This means that the grid has defined note and chord placements rather than traditional piano style sequencing layout. The Deluge column steps are one semitone and the rows five semitones (a perfect fourth) apart. In layout terms Deluge is therefore more akin to a bass guitar fretboard than it is to a piano keyboard. From a grid playability perspective this makes perfect sense. Pressing a note on the grid will also highlight the equivalent notes, up and down an octave, on the grid.

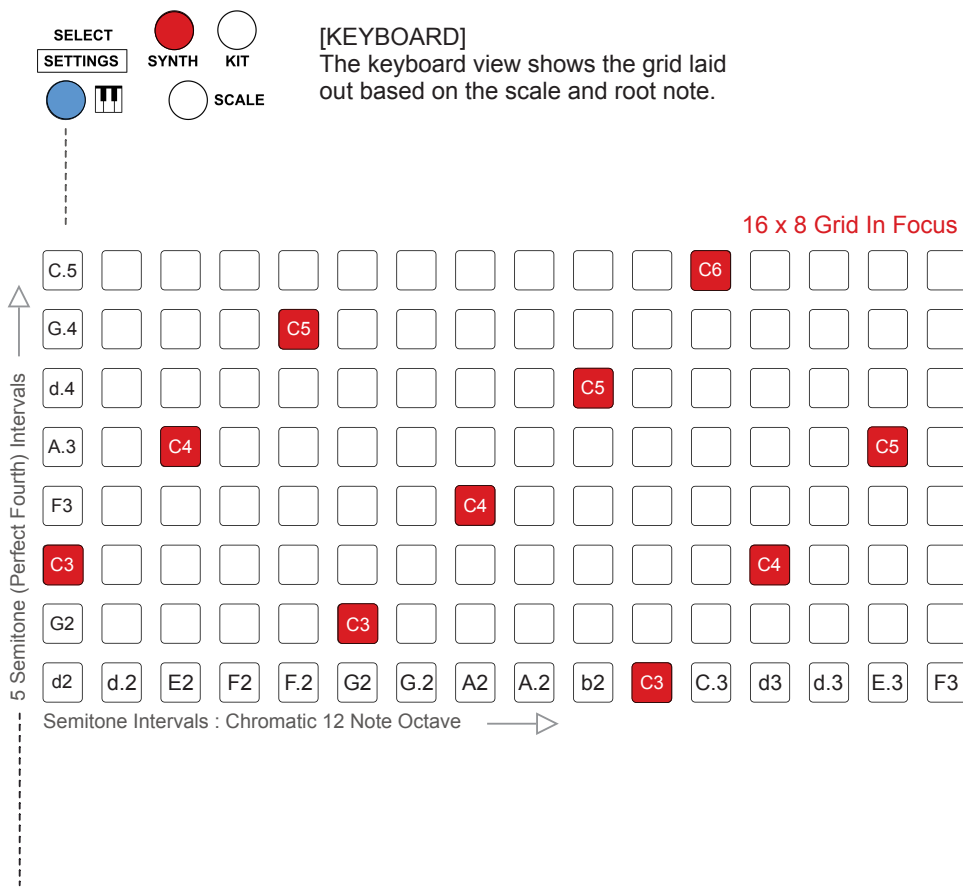

Steps up the rows in five semitone (perfect fourth) intervals and the columns steps in one semitone steps.

NOTES

These octaves will follow a consistent pattern shape of the notes between the octaves. Chords played on a piano are shaped uniquely across the scale (for example 12 chord shapes in a minor chord for each root note). With Deluge, chords follow a consistent shape. This is known as an *isomorphic* layout where each chord always follows the same shape.

Example of Isomorphic Chord Shapes

Minor & Major Chords
Examples show minor and major chords and how the shape can be replicated across the grid for these chords and associated note structures.

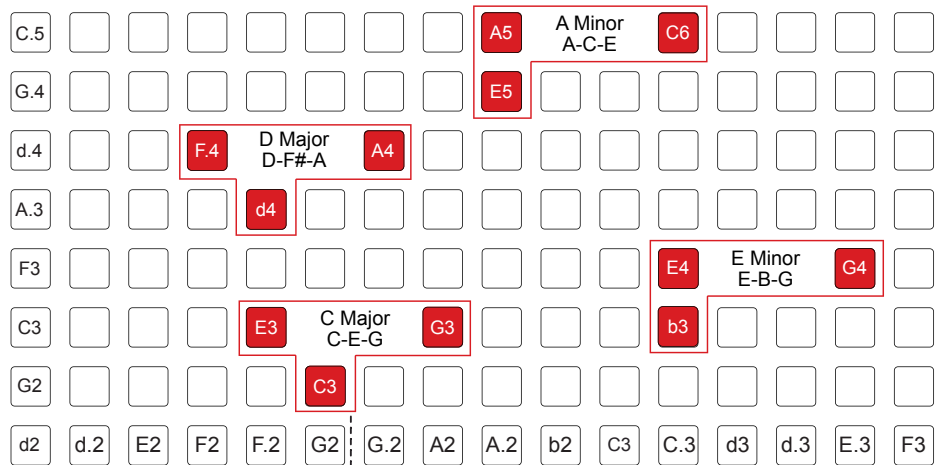

Chord Shapes
Examples show minor and major chord shapes and how they are replicated across the grid for the respective chords.

More isomorphic chord examples are shown in the community quick reference guide in section 15 of this manual. .

3 Sequencer

3.8 Navigating the Grid

Deluge has a 16 x 8 grid of pads which is used when sequencing notes and creating melodies and patterns. The actual programming grid is not limited to the 16 x 8 pads in focus and on view.

Scrolling The Grid

Higher and lower notes (synth) or different samples (kit) can be scrolled up and down or longer time sequences left / right are available. The focus area can be scrolled and zoomed across the pattern real estate to suit your workflow and area of interest.

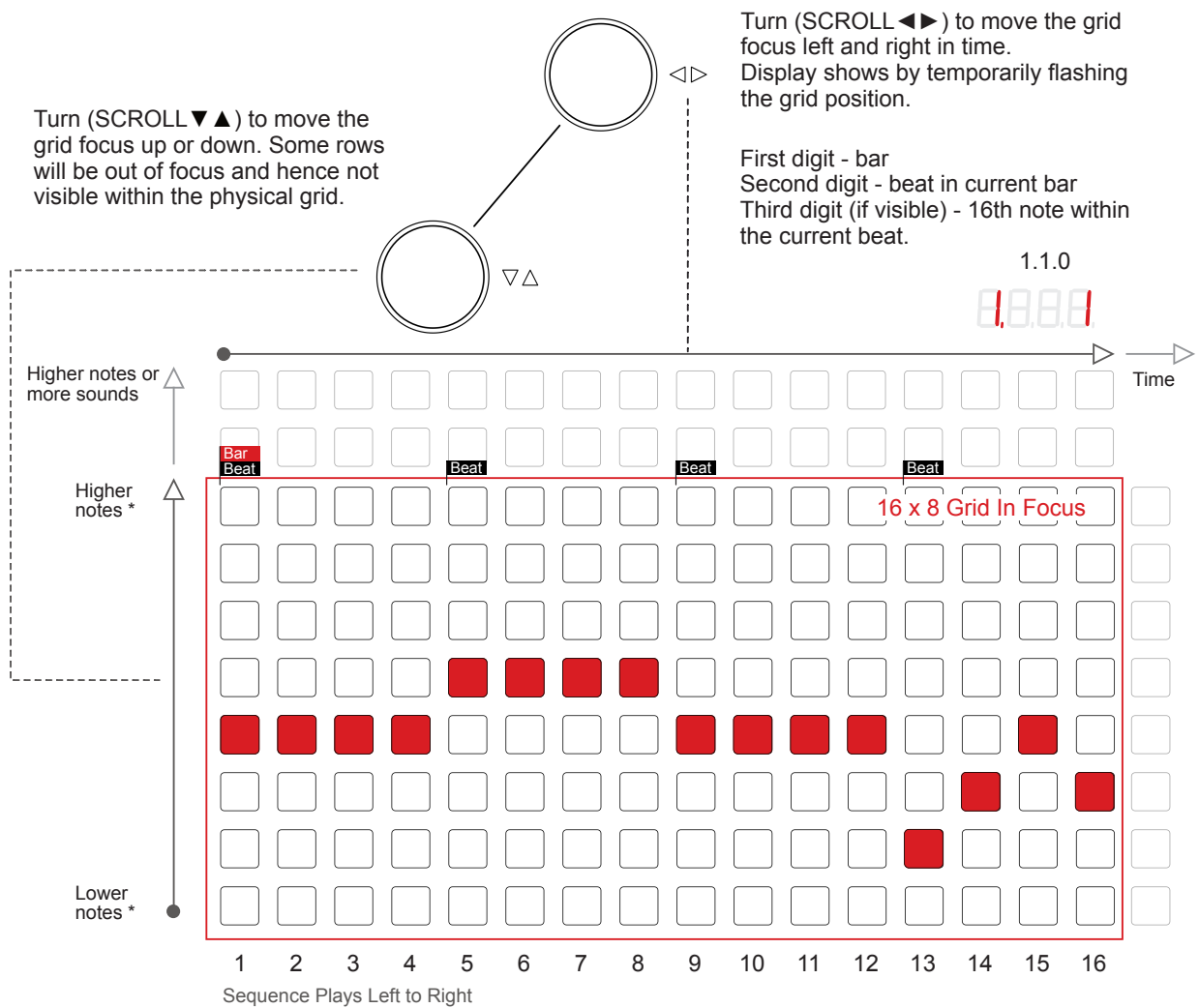

Default: 16th notes represented by each column of the grid.

16EH

Press (SCROLL $\blacktriangleleft \blacktriangleright$) to check the current zoom setting as shown on the display.

* Rows represent notes for a synth (illustrated) and samples for a kit

Zooming The Grid

Zooming the grid also uses the scroll and zoom rotary control. Zooming is performed across the horizontal timeline of the grid. The grid resolution will change to the zoom level selected and as such may include more or less visible information. Zooming-in is possible from the 16th default to 128th notes.

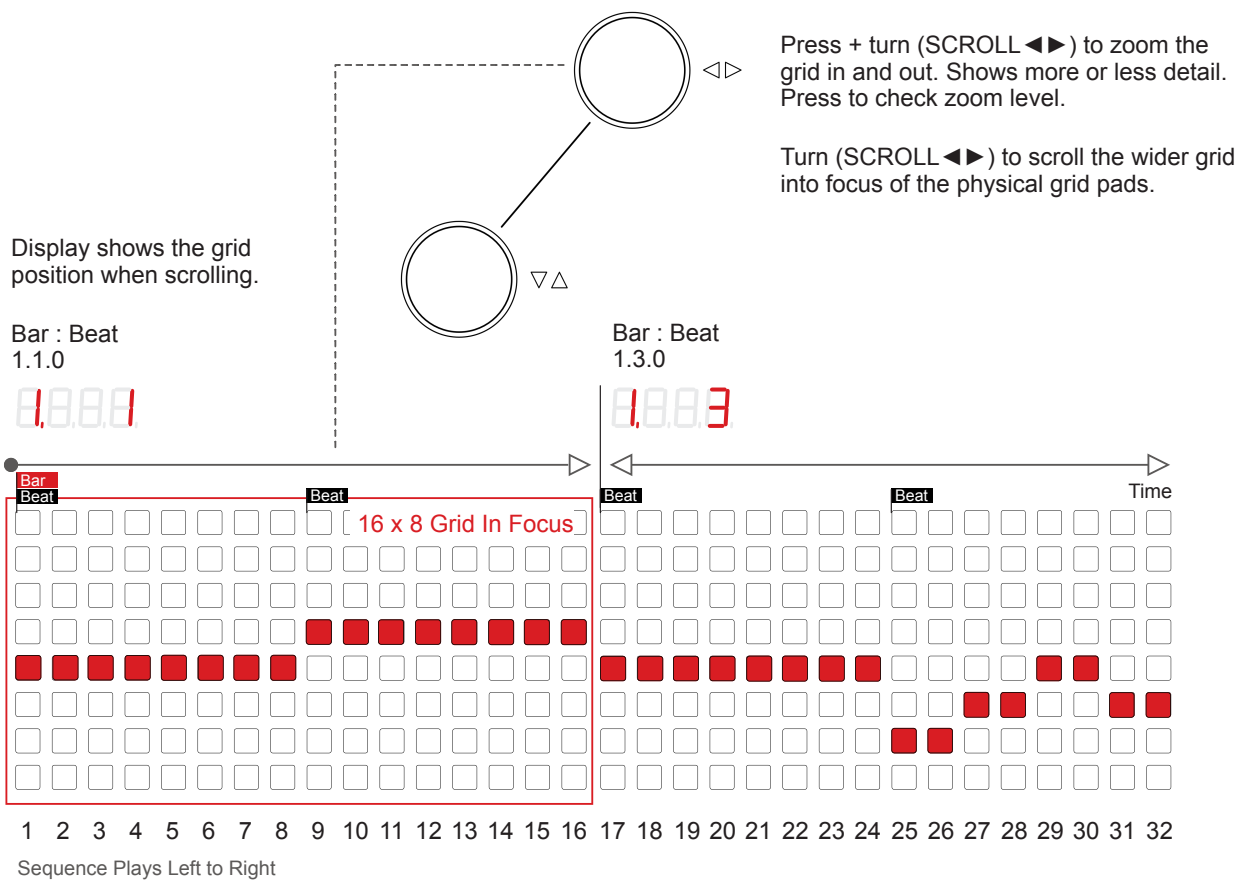

Note / step detail is expanded or contracted. Moving from the default 16th view to 32nd view will still be one bar but add more resolution detail effectively doubling the note / step detail from the first 8 columns of the 16th view across to the entire 16 columns in 32nd view.

Example: 32nd notes representing the zoomed grid.

3288

Press (SCROLL ◀▶) to check the current zoom setting as shown on the display.

3 Sequencer

SCROLLING CLIPS HORIZONTALLY

1. Press [CLIP] to select clip view. This is indicated by the clip button illuminated blue.
2. Select SYNTH or KIT by pressing [SYNTH] or [KIT]. The selected button illuminates red.
3. Turn (SCROLL ◀▶) to scroll the grid in focus. If there are no notes / steps existing beyond the visible pad grid then no scrolling will take place. Scrolling will move by the full page of 16 steps.
4. Editing of notes and steps is retained irrespective of whether the notes are in focus and viewed within the pad grid. Horizontal scrolling adjust the step columns in focus based on the time division

SCROLLING CLIPS VERTICALLY

1. Press [CLIP] to select clip view. This is indicated by the clip button illuminated blue.
2. Select SYNTH or KIT by pressing [SYNTH] or [KIT]. The selected button illuminates red.
3. Turn (SCROLL ▼▲) to scroll the grid in focus. Scrolling will take place. Scrolling will move by one row at a time and for synth notes the audition pads will show the root note position for synths and the selected row for kits.
4. Editing of notes and steps is retained irrespective of whether the notes are in focus and viewed within the pad grid. Vertical scrolling adjusts the step rows in focus based on the note pitch for synths or specific sounds for kits.

ZOOMING THE GRID HORIZONTALLY

1. Press [CLIP] to select clip view. This is indicated by the clip button illuminated blue.
2. Select SYNTH or KIT by pressing [SYNTH] or [KIT]. The selected button illuminates red.
3. Press + turn (SCROLL ◀▶) to zoom the grid showing more or less detail. Step resolution will expand up to 128th notes and shrink depending on the zoom level. Default is 16th notes.
4. The bar, beat of the current bar and (if visible) the 16th note in the current beat flashes for a short period on the display as adjustments are made.



1.3.0

CHECKING ZOOM LEVEL RESOLUTION

1. Press [CLIP] to select clip view. This is indicated by the clip button illuminated blue.
2. Select SYNTH or KIT by pressing [SYNTH] or [KIT]. The selected button illuminates red.
3. Press (SCROLL ◀▶). The display will flash showing the timing division resolution depending on the clip length. Examples are:-



16th notes

32nd notes



64th notes

128th notes

3 Sequencer

3.9 Clip Length & Position

NOTES

Default clip length is 1 bar. This however can be changed which will extend the sequence beyond the grid in focus. This can be navigated using the scroll and zoom features. Automatic extending of clips will take place if recorded to a blank clip (no notes or sounds).

ADJUSTING CLIP LENGTH

1. Press [SHIFT] + turn (SCROLL ◀▶) control to adjust the clip length. Clockwise to increase length. Anti-clockwise to reduce clip length.
 - The display will show the length in bars : beats : 16th notes.
 - The column pads on the grid will also indicate the clip length by illuminating dim grey for columns outside of the length. The grid columns within the length will be unlit / off.
 - Automatic scrolling will take place if the length is extended further beyond the right side columns. Automatic zooming will take place when clip length is reduced less than half of the grid.

16th note examples:

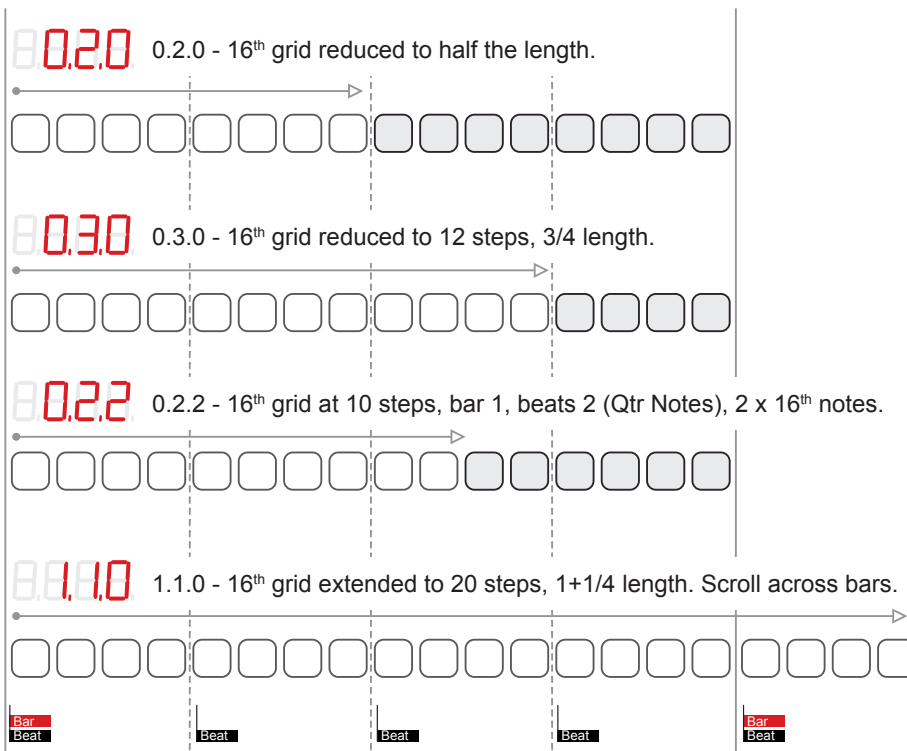

DUPLICATING PATTERN CONTENTS - MULTIPLY CLIP LENGTH

1. Press [SHIFT] + press (SCROLL ◀▶) to duplicate the clip length once and associated pattern.
 - Automatic zooming out will take place when clip length is increased. The grid resolution time division may automatically change for example from 16th to 8th notes.
 - Multiplying again will therefore 'double' the 8th note view.
 - Zoom can be restored and scrolling to view across the entire grid if required.
 - Any iteration dependance settings may be automatically changed when duplicating / multiplying in order to retain the same sounds as the original clip.

[SHIFT] + press (SCROLL ◀▶)

Grid sequence pattern is duplicated to extend the entire sequence length.

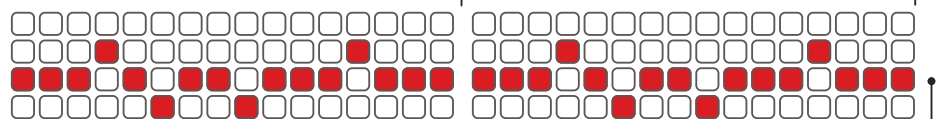

Press (SCROLL ▼▲) + turn (SCROLL ◀▶)

Note events can be moved left and right on the grid. Any note events which scroll off the grid will wrap to the opposite side.



3 Sequencer

3.10 Cross-Screen Editing

NOTES

Cross-screen editing enables duplicated patterns across multiple, equivalent zoom level screens to be edited in-sync with the current screen displayed on the 16x8 grid. This means changing one screen, for example, to add an extra kick at the end of a bar, will be applied to all other out-of-view screens.

APPLYING EDITS ACROSS MULTIPLE SCREENS

1. Select a pattern and duplicate it to match your needs. Example 1 bar pattern duplicated twice and visible across 4 x 'screens', of the 16x8 grid with 16th resolution.
2. Ensure the screen to edit is in focus. Example, first bar of a 4 bar pattern at 16th resolution.
3. Edit the pattern as desired. Example, place extra kick at the end of the pattern, first bar. The edit will only affect the first bar.
4. Press [CROSS-SCREEN] to switch the mode on. Button lit.
5. Edit the pattern as desired. Example, place extra kick at the end of the pattern, first bar. The edit will be changed in the first bar in view and also bar 2,3 and 4 off screen.
6. Edits in cross-screen mode are dependant on, and locked to the zoom level. Example, if 8th note resolution displays 2 bars in view and changes are made in cross-screen mode at the end of bar 2, this will also change at the end of bar 4, the screen out of view.

Clips individually remember whether, and at what zoom level, they have cross-screen edit mode applied. Entering the mode for one track will not automatically be active for any other track that is then edited.

Cross-Screen edit mode

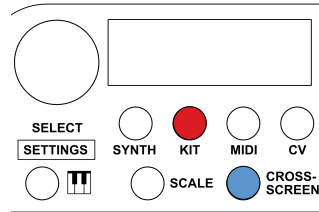

In cross-screen edit mode, changes within the current screen that is in focus i.e. 16th notes / 1 bar, will be reflected across the other equivalent screens that are not in-focus.

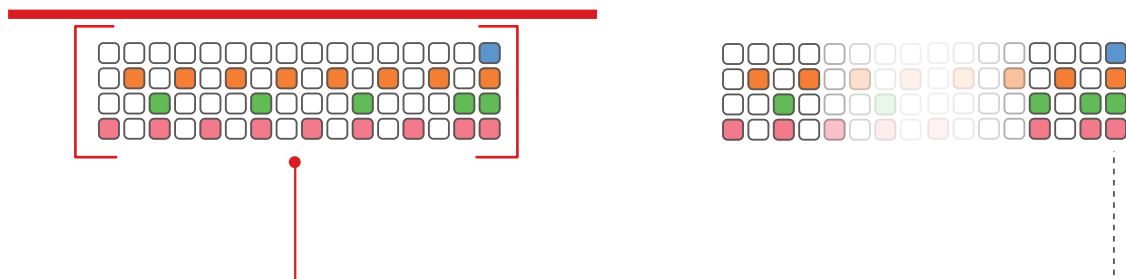
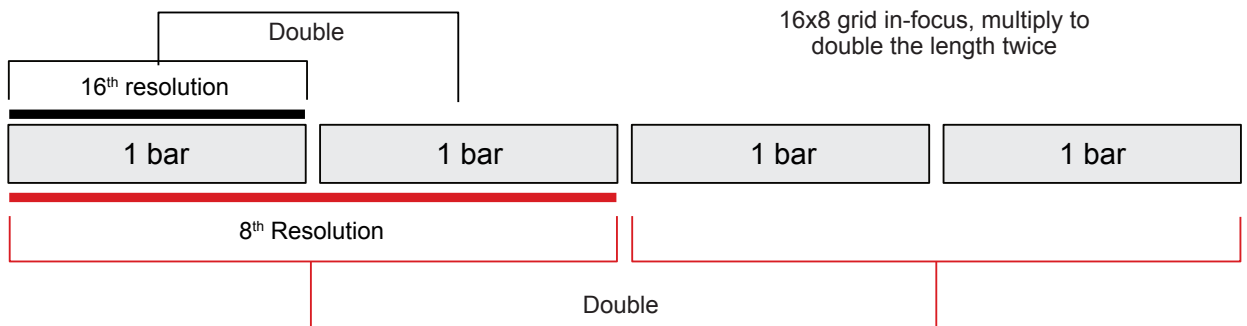
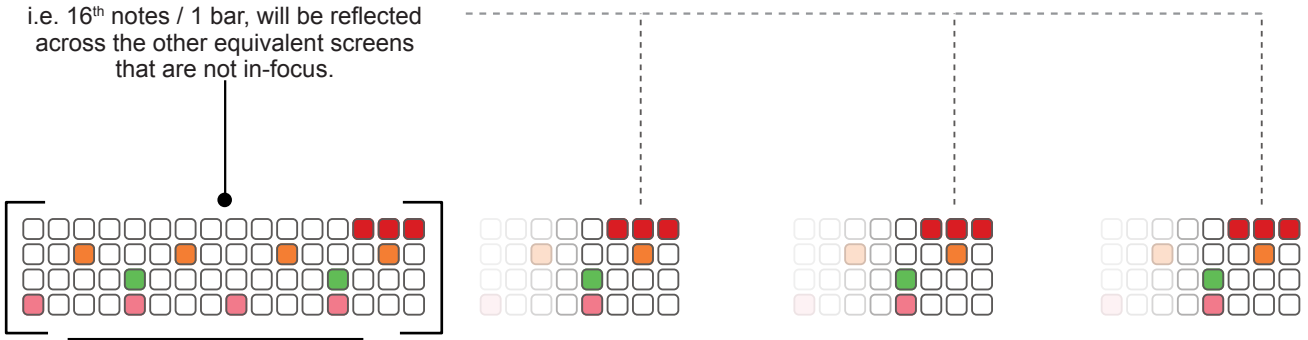

In cross-screen edit mode, changes within the current screen that is in-focus i.e. 8th notes, 2 bars will be reflected across the other equivalent screens that are not in-focus.

3 Sequencer

3.11 Note Creativity: Probability & Iteration Dependence

Deluge has a number of features that bring even more creativity to sequencing. Note probability and iteration dependence is a feature which uses logic to determine if the note plays on the sequence cycle or not and adds randomness.

Probability

SETTING A NOTE PROBABILITY TO ADD RANDOMNESS

1. Press & hold one or more [PAD] + turn (SELECT) anticlockwise. The pad's selected should represent the sequence notes of where to add probability.
2. Adjust the (SELECT) percentage between 5-100% where the % is the 'chance' of the note being played.
3. To reset to default set the % to 100% where the note will be played each iteration.

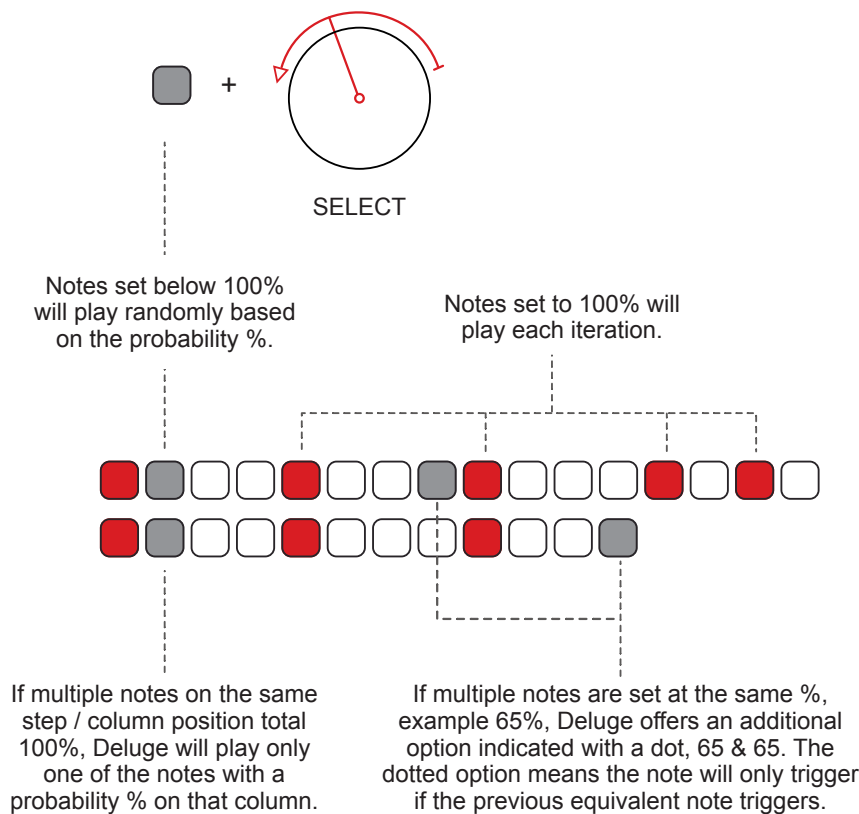

Iteration Dependence

SETTING A NOTE ITERATION DEPENDANCE

1. Press & hold [PAD] + turn (SELECT) clockwise. Pad selected should represent the sequence note of where you intend to add the iteration.
2. Adjust the (SELECT) setting to one of the settings between '1 of 2' up to '8 of 8'.
3. The ratio represents when the note plays for every iteration (bar) that the sequencer plays. So '1 of 2' plays the note on the 1st of every 2 bars, '3 of 4' plays on the 3rd of each 4 rotations.

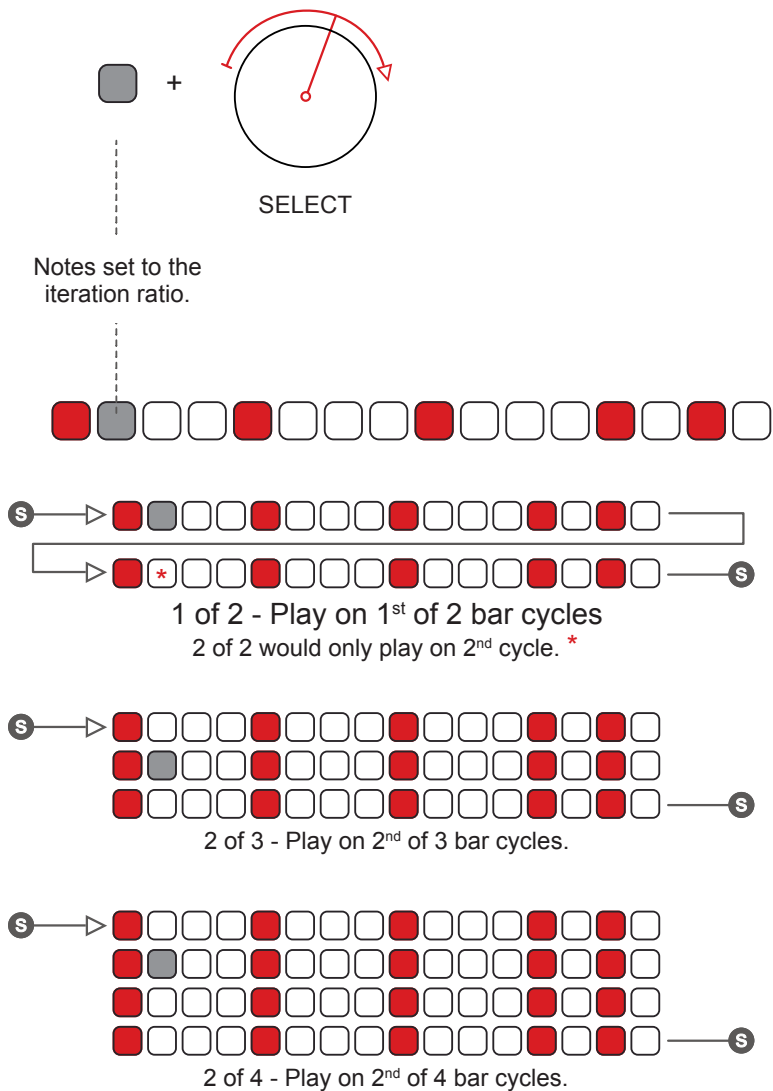

3 Sequencer

3.12 Parameter Automation

NOTES

Parameter automation is the creation and playback of automated changes to sound parameters, sequenced in conjunction with the other contents of a clip on the Deluge. A filter *sweep* would be one common example of.

RECORDING PARAMETER CONTROL MOVEMENTS

1. Start recording with [RECORD] and then [PLAY].
2. Select a parameter to record, example *pan* - [LEVEL / PAN], button illuminates orange. Other parameters can be used along with the (UPPER) (LOWER) control.
3. Adjust (LOWER) - pan, control while recording. The changes in the parameter will be recorded in time with the sequence.
4. Automation is overwritten if the sequence loops while changes are being made.
5. The automation changes are recorded from the point of change to the point where changes stop. A smooth transition will be automatically made back to the original to ensure a smooth continuous loop.
6. The parameters with automation attached can still be manually changed. The sequencer will transition back to the automated parameter pathway once manual changes are completed.
7. Automation is independent of notes so will remain even if notes are deleted.

RECORDING MANUAL PARAMETER CHANGES PER PAD

1. Set to [CLIP] view.
2. Select a parameter to record, example *pan* - [LEVEL / PAN], button illuminates orange. Other parameters can be used along with the (UPPER) (LOWER) control.
3. Press and hold [PAD] at the desired step + turn (LOWER) - pan. The changes in the parameter will be made as a snapshot at the specific note step / time slot and end at the next note / step.
4. Deluge treats any region of automation as if the entire clip is automated.
5. Automation is independent of notes so will remain even if notes are deleted.

Example: Automating Pan with Controls

Automation is recorded into the sequencer and can be played back. Adjusting the (LOWER) - for pan, control with the target - level / pan, parameter selected.

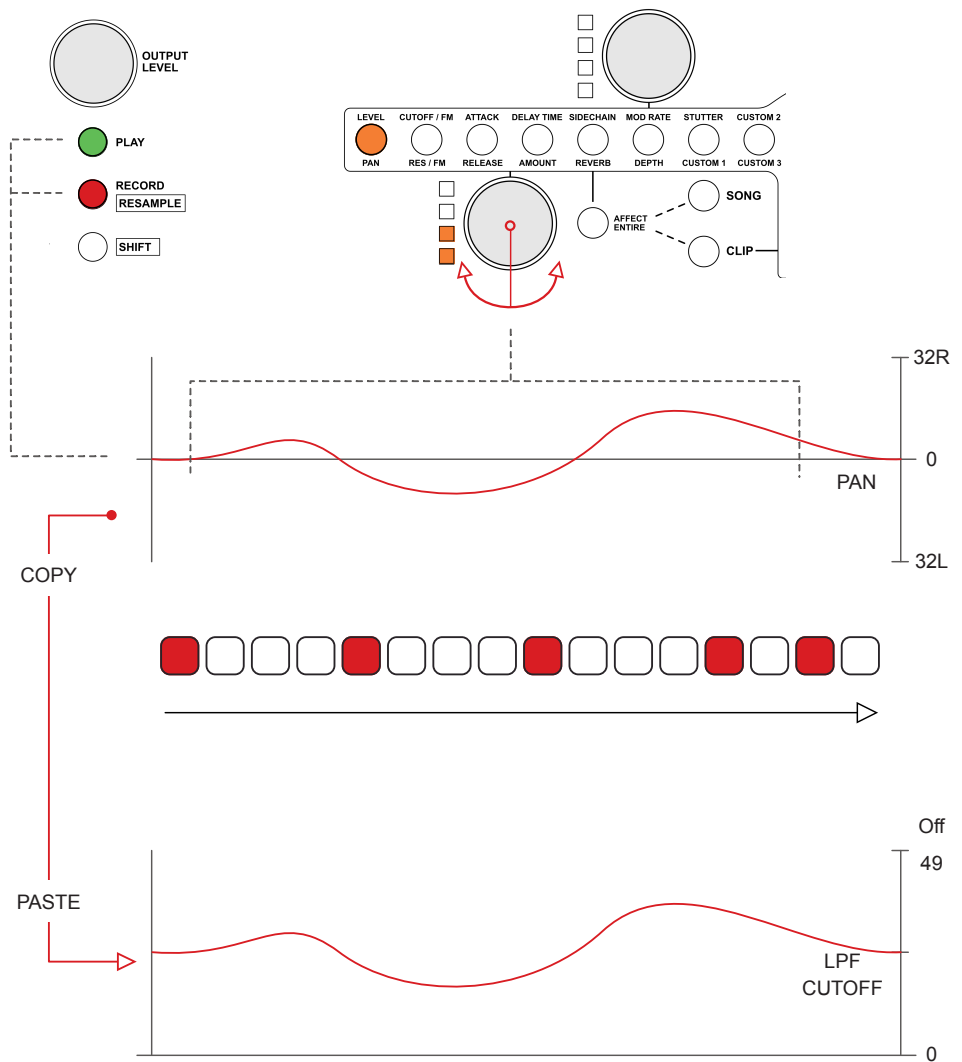

[LEARN / INPUT] + [PARAMETER CONTROL]
to copy the automation of one parameter.

[SHIFT] + [LEARN / INPUT] + [PARAMETER CONTROL]
to paste the copied parameter automation.

Automation copy / paste operates across the time region length of the 'view'. Automation can be copied to / from different parameters, different clips and song files. Zoom levels can be adjusted prior to copying and automation will be adjusted to meet the new zoom setting.

3 Sequencer

NOTES

Example: Automating Pan with Note Steps

Automation is recorded into the sequencer by holding a [PAD] and adjusting the (LOWER) - For *pan*, control with the target - level / pan, parameter selected. A parameter change is set for the specific [PAD] step and is held until the next note to ensure transitions account for note release. Copy / paste considers the entire region automation, not just the single step.

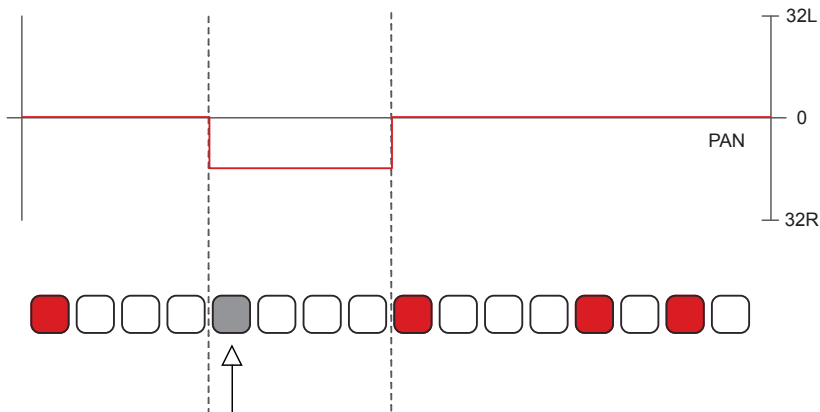
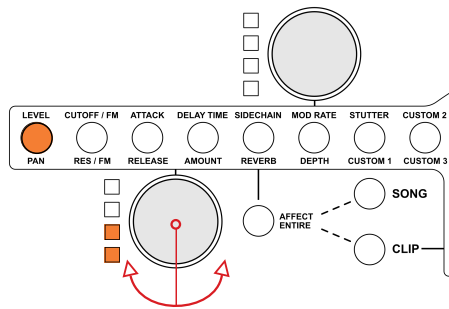

(SCROLL ◀▶) + [BACK / UNDO]
to clear all notes and automation.

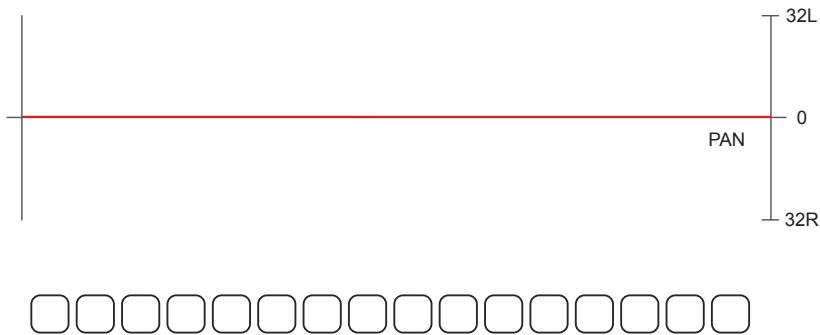

DELETING RECORDED AUTOMATION FOR A SPECIFIC PARAMETER

1. Select a parameter to delete, example pan - [LEVEL / PAN], button illuminates orange.
2. Press [SHIFT] + press (LOWER) - pan, upper or lower to match the parameter to delete.
3. Automation is deleted and the display will indicate 'dELE' to confirm deletion.
4. The automation changes can be undone using [BACK / UNDO] or [SHIFT] + [REDO].

COPY / PASTE AUTOMATION FOR TIME REGION OF PADS

1. Select a parameter to copy, example pan - [LEVEL / PAN], button illuminates orange.
2. Press [LEARN / INPUT] + press (LOWER) - pan, i.e. upper or lower to match the parameter to COPY. Note, automation is copied for one individual parameter at a time.
3. Display indicates 'CoPY'. If no automation is present then the display will show 'nonE'.
4. Select a destination parameter to paste to, example cutoff - [CUTOFF / RES], button illuminates orange.
5. Press [SHIFT] + [LEARN / INPUT] + press (UPPER) - cutoff, i.e. upper or lower to select the parameter to COPY to. Note, automation is copied for one individual parameter at a time.
6. Display indicates 'PAStE'. If no automation has been copied then the display will show 'nonE'.
7. The automation changes can be undone using [BACK / UNDO] or [SHIFT] + [REDO].

Stutter parameter cannot be automated. MIDI control can also be automated via MIDI messages. External MIDI controls can be automated on Deluge parameters.

3 Sequencer

3.13 Euclidean Sequencing

NOTES

Euclidean sequencing is based on greek mathematical principles and specifically around the division of two numbers. This process is applied to generate the placement of steps in a musical sequence across a defined length. Euclidean sequencing is great for more generative sequencing which creates evolving melodies and especially rhythmic patterns. Deluge applies euclidean patterns per row and the three elements to setup are:-

- Number of events. Basically sets how many steps will be applied in the row. Process is similar to note repeat.
- Length of the sequence row, similar to clip length.
- Position of notes. The shifting of notes in the pattern.

■ CREATING A EUCLIDEAN PATTERN

1. Set to [CLIP] view.
2. Identify the note and hence the row on which to apply the sequence. Holding the [AUDITION] button for the row will apply the sequence. Press [SHIFT] + [AUDITION] in the steps below to apply the sequence silently.
3. Press and hold [AUDITION] + turn (SCROLL ◀▶) to set the row length.
4. Press and hold [AUDITION] + press and turn (SCROLL ▼▲) to set the number of events and an assigned position on the selected row.
5. Press and hold [AUDITION] + press and turn (SCROLL ◀▶) to adjust the note placement by shifting / rotating through the grid.
6. Repeat these steps for other notes / rows to build layered euclidean sequences and melodies.

Example: Euclidean Patterns

Applying euclidean patterns is performed row by row and is an iterative process for each row in a pattern where a euclidean generates pattern is required. The creativity in euclidean sequencing comes from the layering of rows with different lengths and a variety of events to build complex patterns and melodies.

Hold [AUDITION] or for silent row selection, [SHIFT] + [AUDITION] + the respective scroll control to set euclidean patterns to the selected row.

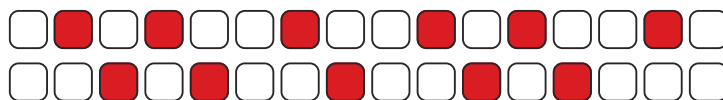
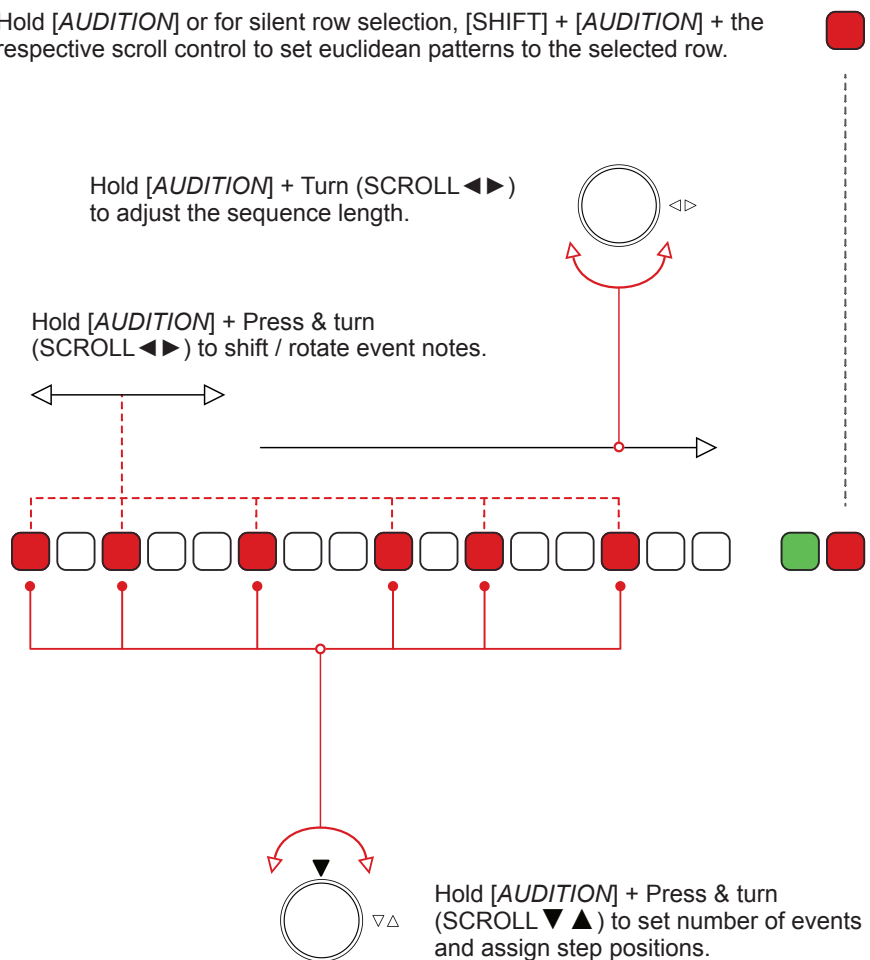

Multiple euclidean sequenced rows with varying lengths adds interest and the perception of generative patterns. Try with kit rows to build interesting percussive beats.

— SYNTHESIZERS —

4 Synthesizer

4.1 Synthesizer Concepts

NOTES

Deluge features subtractive, FM and wavetable synthesis with many customisable options. Some generic synthesis concepts are explained below.

Subtractive Synthesis

Subtractive synthesis operates on the principle of one or more oscillators which generate a tone with harmonic content dependant on the wave shape and type. Harmonic frequencies are then 'carved out' using filters to subtract various elements from the signal. This affects the timbre and sound. Additional sound shaping with envelopes, modulation and effects enables more complex sound design.

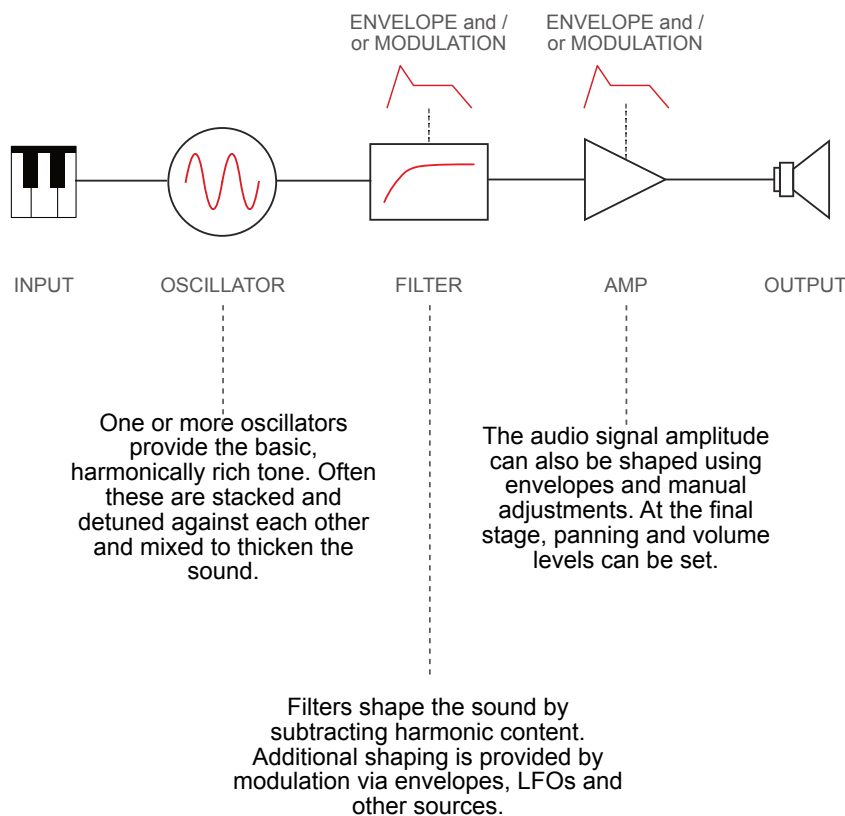

The basic subtractive concepts are shown in the diagram with many synthesizers expanding these concepts with more complex layering, synchronisation and tuning of oscillators, complex waveforms and noise generators, filters, modulation, effects and more.

4.1 Synthesizer Concepts (cont)

FM Synthesis generates sounds which are often described as metallic or bell-like. The generic concepts of FM Synthesis are explained.

FM Synthesis

FM (frequency modulation) synthesis operates on the principle of an oscillator or “operator” generating an initial, basic wave known as the carrier. This then has its frequency rapidly modulated by an additional wave/oscillator known as the modulator. The exact configuration of, at times many carriers and modulators, is called an algorithm. Technically FM synthesis is just very fast vibrato - so fast that the modulation of frequency occurs at a rate which is itself in the “audio range”.

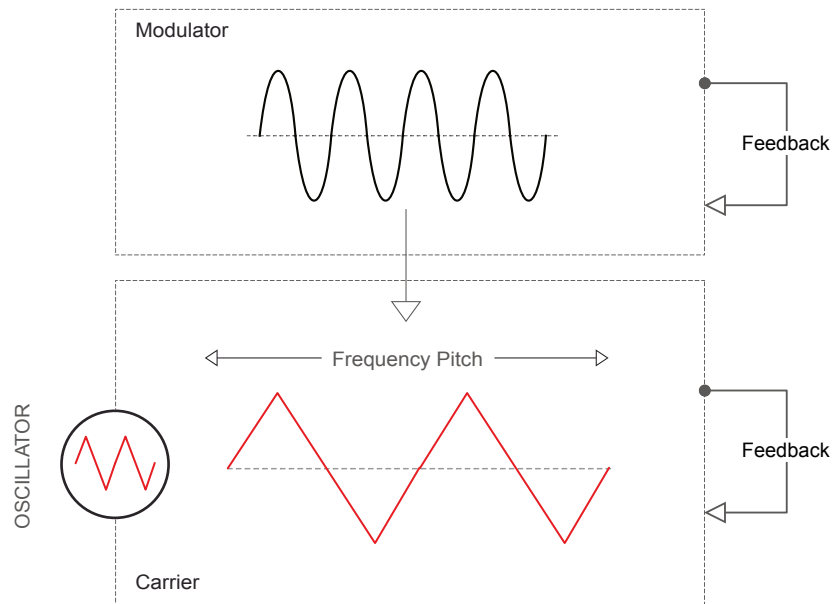

By rapidly modulating the frequency of a wave, whole new repeating wave shapes are created.



Amplitude modulation can be carried out by other modulation devices such as LFO's. Amplitude modulation can be found in many types of synthesizer.

4 Synthesizer

4.1 Synthesizer Concepts (cont)

NOTES

The third synthesizer type in Deluge is wavetable synthesis.

Wavetable Synthesis

Wavetable synthesizers use a collection of wave assembled into a package of wavetables. While subtractive synthesis uses a core wave-shape as its audio source, wavetable synthesizers use wavetables as the audio source. The key benefit being the ability to navigate parts of the wavetable to generate different timbres and sounds. This is essentially the synth oscillator.

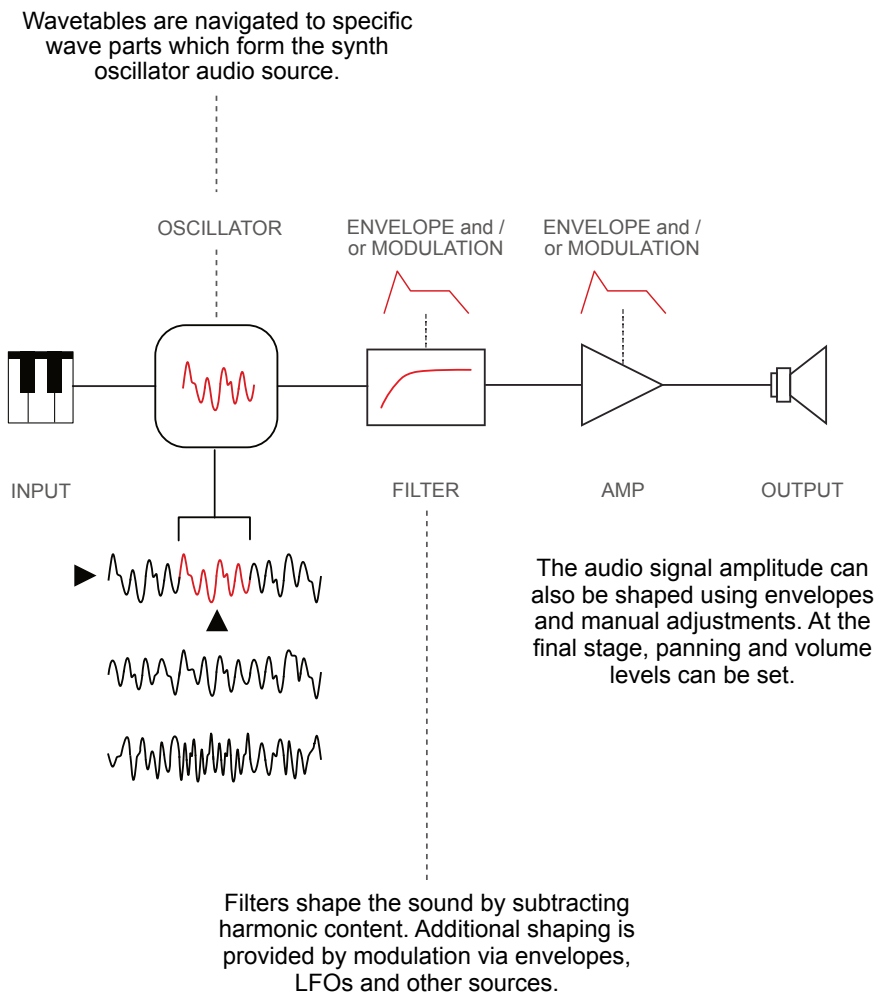

The basic wavetable synthesis concepts are shown in the diagram. The core components are the wavetables as a source, typically generated from single cycles, and the ability to navigate the wavetable. Most other features and synth specific and often similar to subtractive synthesis.

4.2 Deluge Subtractive Synthesizer Overview

Deluge has a subtractive synthesizer as default, with ring modulation mode option.

Deluge Subtractive Synthesis

Deluge uses two oscillators. High-pass and low-pass filters and 2 LFO and envelope options. In addition the Deluge synth can use sample WAV files as the audio frequency source.

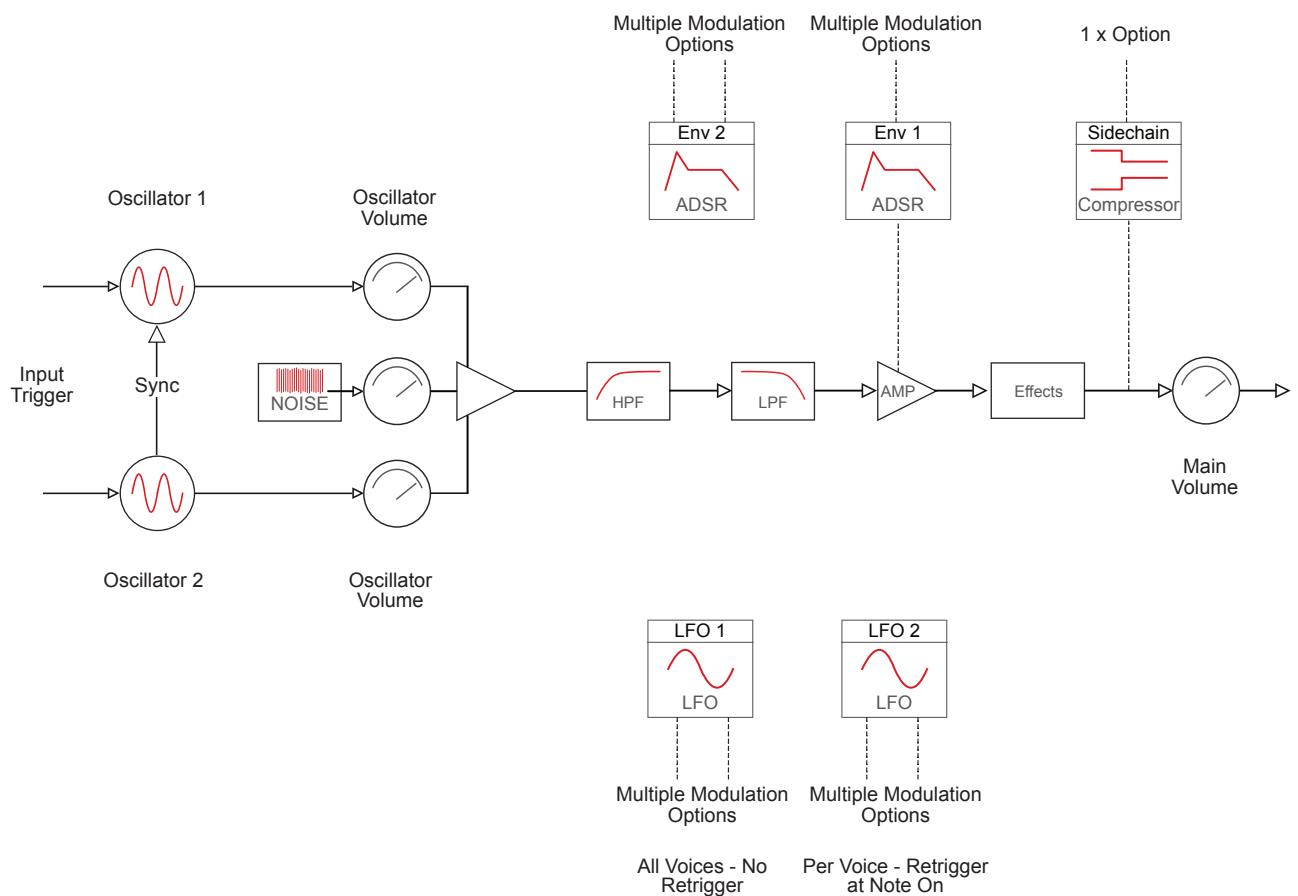

4 Synthesizer

4.3 Deluge FM Synthesizer Overview

Deluge has FM synth features and parameters that are configurable.

Deluge FM Synthesis

Deluge uses two carriers and two FM modulators. Regular modulation is also provided by 2 LFO and envelope options.

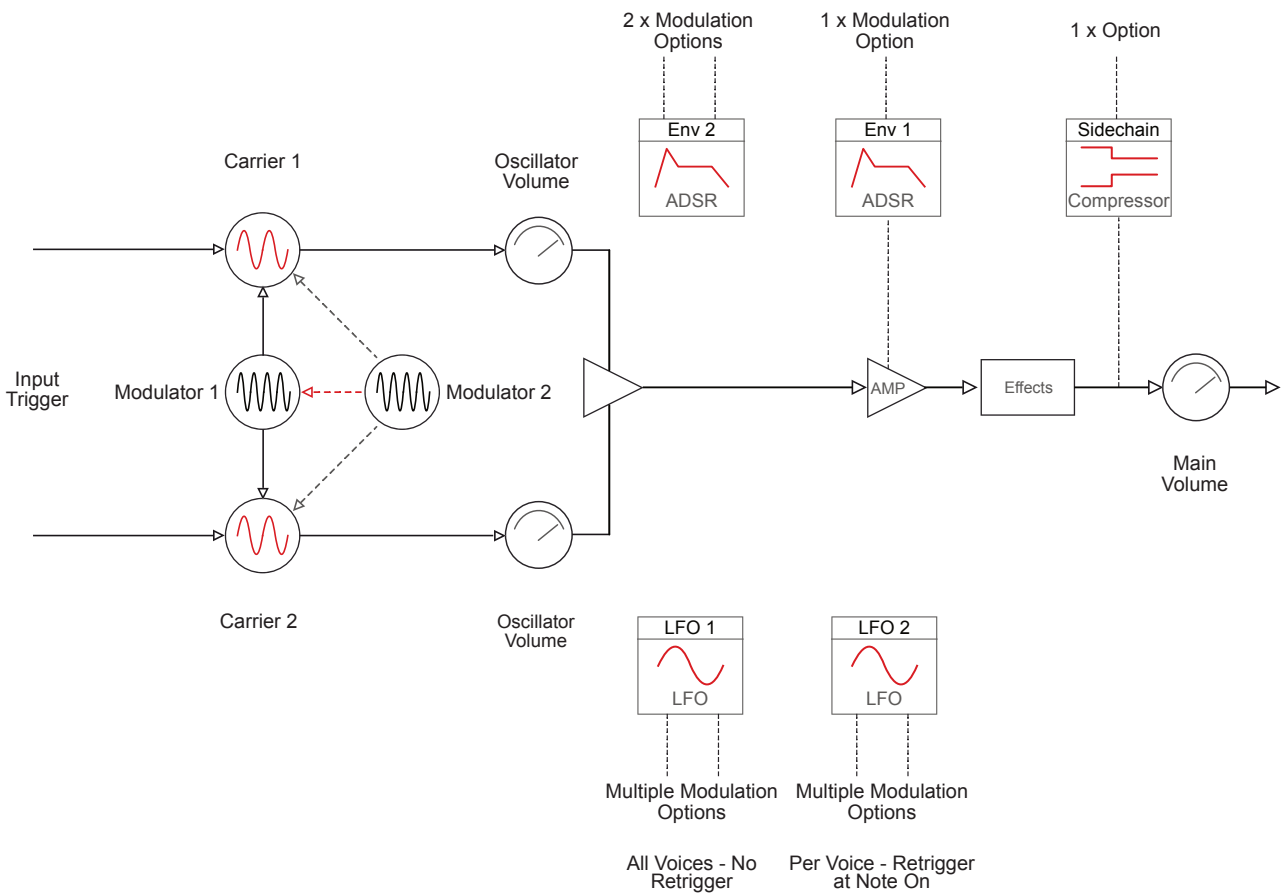

Deluge FM Algorithms

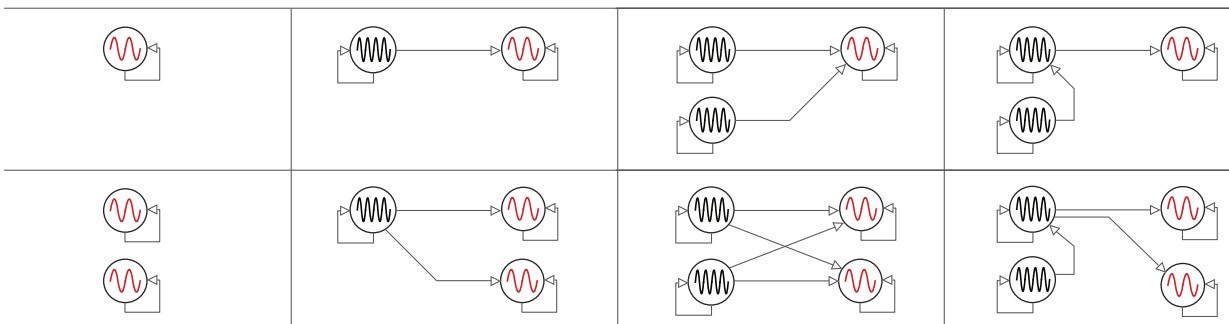

4.4 Deluge Wavetable Synthesizer Overview

Deluge has wavetable synthesizer capability which allows the oscillators TYPE to be set to WAVetable and where a specific part of the wavetable can be selected as the audio source.

Deluge Wavetable Synthesis

Deluge uses two oscillators plus same functionality also as the default subtractive synths and the audio chain. Wavetables in WAV or AIFF and MONO format can be assigned to one or both of the oscillators. Wave navigation per oscillator is also available in order to change the oscillator wave cycle used as the source. Modulating the wave position is a great way to add variation and movement to a sound.

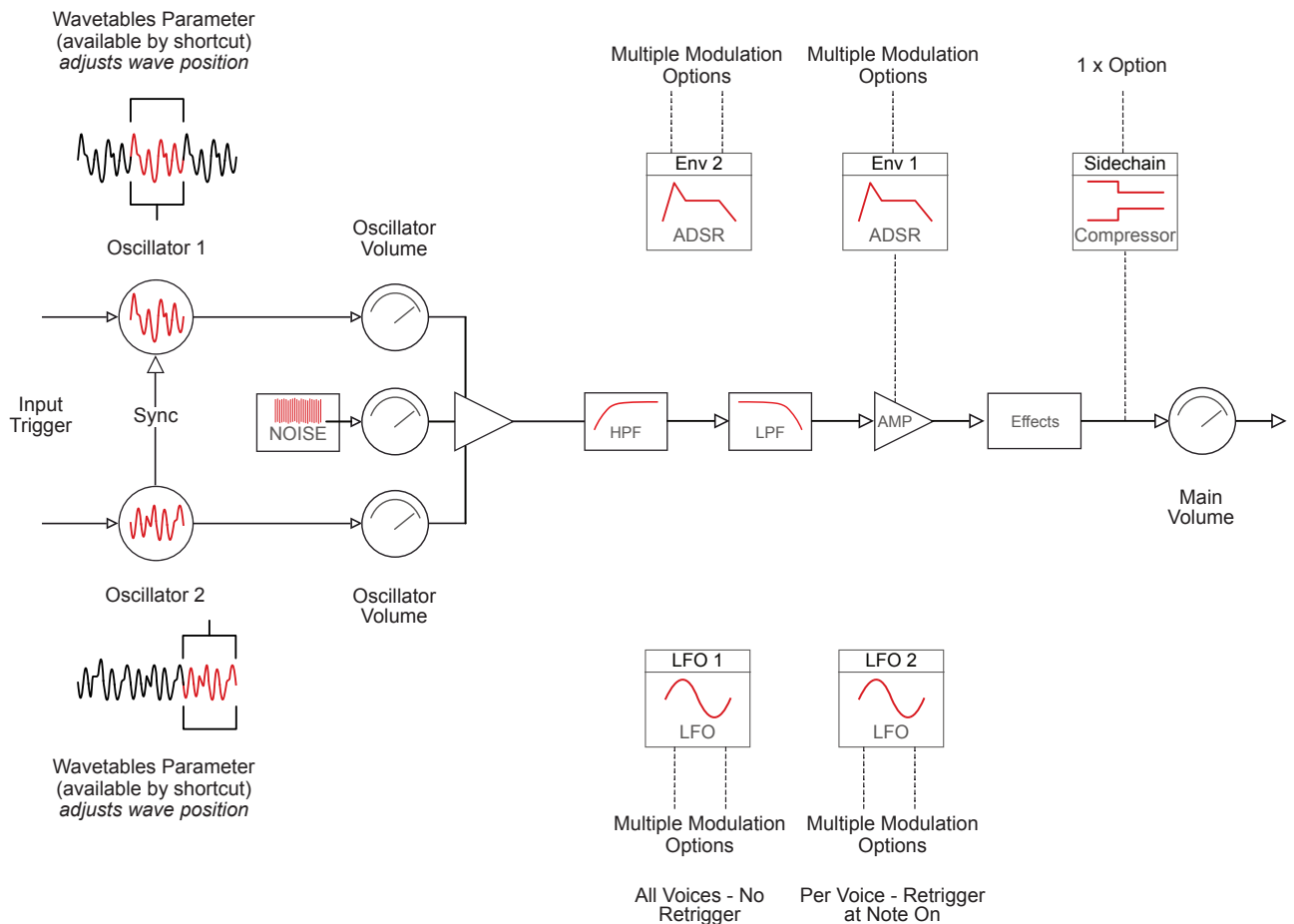

Deluge supports Mono, WAV and AIF files with a cycle size to the 'power of two' starting at 8 upwards. The cycle size of 2048 is the most common. Wavetables can be downloaded freely online from various sources or can be user created directly. These can be stored, and subsequently selected from, the samples library on the SD Card. Many devices such as XFER's Serum VST plug-in have readily available wavetables that are also compatible with the Deluge wavetable synthesizer. These along with any other specific wavetable files carry meta data tagged 'clm' along with the cycle size. Deluge can load any wave file as a wavetable but only the wavetable formatted files will follow the defined and recognised wavetable behaviour and sound.

4 Synthesizer

4.5 Synthesizer Creation Workflow

NOTES

An example high level workflow on setting up the Deluge synths gives a starting point for sound design and preset creation.

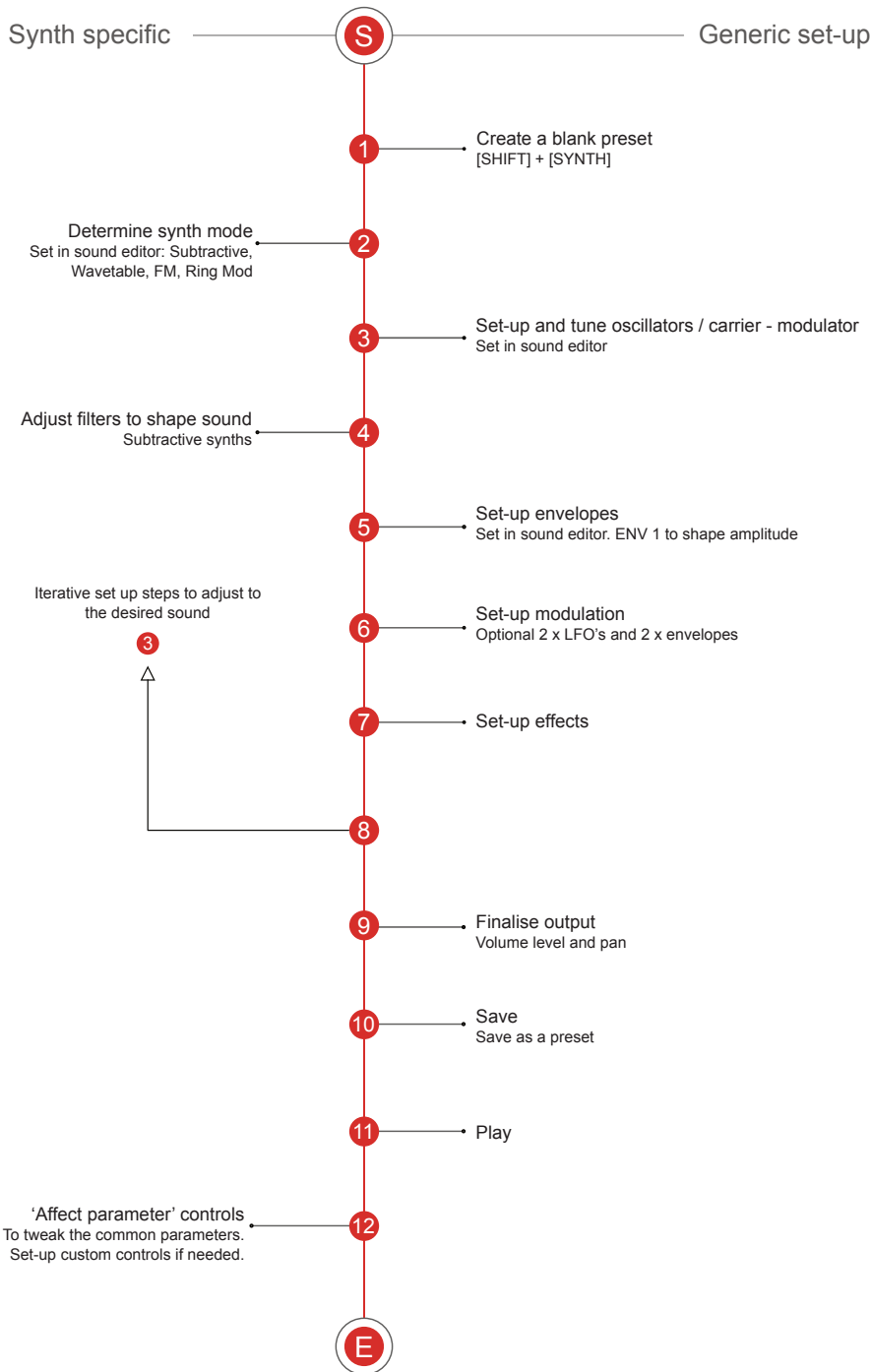

4.6 Synthesizer Clip Parameters

Deluge has the some synth parameters in the affect group. However the full list of parameters is accessible from the sound editor or in part from shortcut options on the grid.

Function	Sub Category Parameter	Shortcut Button Access	Options & Description
OSC 1 CAR 1 - FM	TYPE*	TYPE*	Waveform Options. Digital: Sine, SAW, SQUARE, TRIangle. Analog Modelled: ASAW, ASQUARE. Audio: WAVEtable, SAMPlE, IN (Expandable to INL, INR, INLR)
	VOLUME	LEVEL	Oscillator 1 or Carrier 1 (Car 1) for FM level
	REC	RECORD	Access to sound recorder to sample audio to use as oscillator 1. Not available in FM synth.
	TRANSpOse	TRANSpOSE	Semitones + cents for adjustment
	PULSe Width	PW	Oscillator 1 pulse width. No PW available in FM Mode
	FEEDback	FEEDBACK	FM synth option only
	RETRigger Phase	RETRIG PHASE	Phase in degrees that the oscillator will be reset on note-on. Also can be switched off.
OSC 1 CAR 1 - FM	WAVEtable	WAVETABLE	Wavetable Only. Navigation setting to select the cycle position in the wavetable file as the oscillator sound source. Shortcut button only once a wavetable type is set.
	FILE	BROWSE	Only available when TYPE is SAMPlE or WAVEtable: Access to file browser to select audio or wavetable file as oscillator 1
	START	WAVEFORM then 'green' pad	Only when TYPE is SAMPlE: Start time of sample in seconds with millisecond adjustments
	END	WAVEFORM then 'red' pad	Only when TYPE is SAMPlE: End time of sample
	SPEED	SPEED	Only when TYPE is SAMPlE: Manually time stretches sample to play faster or slower without changing pitch. Not available if MODE is set to STREtch in which case speed is controlled by note length and tempo
	REVERse	REVERSE	Only when TYPE is SAMPlE and a sample is loaded, reverses the sample
	MODE	MODE	Only when TYPE is SAMPlE and a sample is loaded: Options are; ONCE - Sample plays once all the way through, CUT - Sample aims to play all the way through but will cut at the triggering note end, LOOP - Sample loops continuously until the trigger note ends, STREtch - Sample is time stretched to the trigger note length.
	PISP	PITCH/SPEED	Only when TYPE is SAMPlE and a sample is loaded: Pitch / Speed controls the relationship between pitch and speed. LINKed - pitch change affects length, INDEpendent - pitch changes do not affect length
	INTErpolation	INTERPOLATION	Only when TYPE is SAMPlE and a sample is loaded: Sample interpolation method used for pitch adjustment. Options are; SINC - high quality 16-point windowed sinc, LINEar - Low quality linear interpolation
	Only when TYPE* is SAMPlE or WAVEtable		

4 Synthesizer

Function	Sub Category Parameter	Shortcut Button Access	Options & Description
OSC 2 CAR 2 - FM	TYPE*	TYPE*	Waveform Options. Digital: SIN, SAW, SQUARE, TRIANGLE. Analog Modelled: ASAW, ASQUARE. Audio: WAVEtable, SAMPLE, IN (Expandable to INL, INR, INLR)
	VOLUME	LEVEL	Oscillator 2 or carrier 2 (Car 2) for FM level.
	REC	RECORD	Access to sound recorder to sample audio to use as oscillator 2. Not available in FM mode.
	TRANSPOSE	TRANSPOSE	Semitones + cents for adjustment
	PULSE Width	PW	Oscillator 2. No PW available in FM Mode
	FEEDback	FEEDBACK	FM Synth option only
	SYNC	OSC SYNC	Switches on the synchronisation for OSC 2 which resets to trigger phase whenever oscillator 1 does.
	RETRigger Phase	RETRIG PHASE	Phase in degrees that the oscillator will be reset on note-on. Also can be switched off.
OSC 2 CAR 2 - FM Only when TYPE is SAMPLE or WAVEtable	WAVEtable	WAVETABLE	Wavetable Only. Navigation setting to select the cycle position in the wavetable file as the oscillator sound source. Shortcut button available only when a wavetable type is set.
	FILE	BROWSE	Only when TYPE is SAMPLE: Access to file browser to select audio file as oscillator 2
	START		Only when TYPE is SAMPLE: Start time of sample in seconds with millisecond adjustments
	END		Only when TYPE is SAMPLE: End time of sample
	SPEED	SPEED	Only when TYPE is SAMPLE: Manually time stretches sample to play faster or slower without changing pitch. Not available if MODE is set to STRETch in which case speed is controlled by note length and tempo
	REVERSE	REVERSE	Only when TYPE is SAMPLE and a sample is loaded, reverses the sample
	MODE	MODE	Only when TYPE is SAMPLE and a sample is loaded: Options are; ONCE - Sample plays once all the way through, CUT - Sample aims to play all the way through but will cut at the triggering note end, LOOP - Sample loops continuously until the trigger note ends, STRETch - Sample is time stretched to the trigger note length.
	PISP	PITCH/SPEED	Only when TYPE is SAMPLE and a sample is loaded: Pitch / Speed controls the relationship between pitch and speed. LINKed - pitch change affects length, INDEPENDent - pitch changes do not affect length
INTERpolation	INTERPOLATION	Only when TYPE is SAMPLE and a sample is loaded: Sample interpolation method used for pitch adjustment. Options are; SINC - high quality 16-point windowed sinc, LINEar - Low quality linear interpolation	
MOD 1 FM Only	TRANSPOSE	TRANSPOSE	Semitones + cents for adjustment
	AMOUNT	LEVEL	Amount which the modulator 1 modulates the frequency of both CAR 1 and CAR 2 Carriers.
	FEEDback	FEEDBACK	Sets the amount of feedback from / to the FM modulator 1
	RETRigger Phase	RETRIG PHASE	Phase in degrees that the oscillator will be reset on note-on. Also can be switched off.

Function	Sub Category Parameter	Shortcut Button Access	Options & Description
MOD 2 FM Only	TRANSpOse	TRANSPPOSE	Semitones + cents for adjustment
	AMOUnt	LEVEL	Amount which the modulator 1 modulates the frequency of both CAR 1 and CAR 2 carriers.
	FEEDback	FEEDBACK	Sets the amount of feedback from / to the FM modulator 2
	RETRigger Phase	RETRIG PHASE	Phase in degrees that the oscillator will be reset on note-on. Also can be switched off.
	DESTination	DESTINATION	Destination carrier for MOD 2 modulator, CARR - Both carriers, MOD1 - modulator 1
NOISe		NOISE	Noise amount in subtractive synths (including sample and wavetable)
TRANSpOse		TRANSPPOSE	Overall master transposition of synth in semitones
VIBRato		VIBRATO	Depth of modulation between LFO1 and pitch on the leader
LPF	FREQUency	FREQUENCY	Cutoff frequency for subtractive synths (including sample and wavetable)
	RESOnance	RESONANCE	Resonance for subtractive synths (including sample and wavetable)
	MODE	DB/OCT	Switches LPF type between 12dB per Octave, 24dB per octave and DRIVE filter (24dB per octave with saturation)
HPF	FREQUency	FREQUENCY	Cutoff frequency for subtractive synths (including sample and wavetable)
	RESOnance	RESONANCE	Resonance for subtractive synths (including sample and wavetable)
MODE		SYNTH MODE	Mode of synthesizer: SUBTractive, RING modulation or FM.
ENV 1 Envelope 1	ATTAck	ATTACK	Attack time for ADSR envelope 1. Default to volume amplitude plus an additional optional patch destination
	DECAy	DECAY	Decay time for ADSR envelope 1. Default to volume amplitude plus an additional optional patch destination
	SUSTain	SUSTAIN	Sustain Level for ADSR envelope 1. Default to volume amplitude plus an additional optional patch destination
	RELEase	RELEASE	Release time for ADSR envelope 1. Default to volume amplitude plus an additional optional patch destination
ENV 2 Envelope 2	ATTAck	ATTACK	Attack time for ADSR envelope 2. Optional patch destinations
	DECAy	DECAY	Decay time for ADSR envelope 2. Optional patch destinations
	SUSTain	SUSTAIN	Sustain Level for ADSR envelope 2. Optional patch destinations
	RELEase	RELEASE	Release time for ADSR envelope 2. Optional patch destinations

4 Synthesizer

Function	Sub Category Parameter	Shortcut Button Access	Options & Description
LFO 1 All Voices. Does not re-trigger.	TYPE	SHAPE	Waveform options: SIN, SAW, SQUare, TRIangle.
	RATE	RATE	Speed of LFO
	SYNC	SYNC	Time interval to sync the LFO or OFF. Options 4 bar, 2 bar, 1 bar, 2 nd , 4 th , 8 th , 16 th , 32 nd , 64 th
LFO 2 Each Voice. Re-triggers at note on	TYPE	SHAPE	Waveform Options: SIN, SAW, SQUare, TRIangle.
	RATE	RATE	Speed of LFO
VOICE	POLYphony	POLYPHONY	POLY - polyphonic, MONO - monophonic, AUTO - monophonic with chord functionality ,LEGA - legato connected / tied, CHOK - choke group settings for kits only.
	UNISon	NUMBER	Number of voices to play together in unison
		DETUNE	Sets how detuned the voices will be from each other in unison
	PORTamento	PORTA	Sets amount of note portamento (pitch slide)
	ARPEggiator	MODE	
SYNC			Time interval to sync the arp or OFF. Options 4 bar, 2 bar, 1 bar, 2 nd , 4 th , 8 th , 16 th , 32 nd , 64 th
OCTAVES			Number of octave range of arpeggiator.1-8
GATE			Amount in % of the available time division which each arp note fills
RATE			Rate / speed of arpeggiator
PRIOrity	PRIORITY		Enables prioritisation of sound so voices remain or are turned off at high CPU loading. Low, med, high options.

Function	Sub Category Parameter	Shortcut Button Access	Options & Description
FX	MODulation FX	TYPE	Type of effect or OFF. Type includes FLANger, CHORus, PHASer.
		RATE	Speed of modulation effect
		FEEDback	Flanger & phaser feedback
		DEPT _h	Depth of chorus and phaser
		OFFSet	Chorus offset
	EQ	ADJUST (BASS)	Amount of bass at the frequency set
		ADJUST (TREBLE)	Amount of treble at the frequency set
		FREQUENCY (BAFR no label)	Frequency setting for bass
		FREQUENCY (TRFR no label)	Frequency setting for treble
	DELAy	AMOUNT	Delay effect and combined feedback
		RATE	Rate of delay
		STEREO (PinG)	Switches between ping pong stereo delay (on) and traditional delay (off)
		ANALOG (TYPE)	DIGItal or ANALog delay
		SYNC	Time interval to sync the Delay or OFF. Options 4 bar, 2 bar, 1 bar, 2 nd , 4 th , 8 th , 16 th , 32 nd , 64 th
	REVERb	AMOUNT	Amount of reverb applied
		ROOM SIZE	Room size applied to the whole song
		DAMPENING	Dampening of the reverb effect
		WIDTH	Stereo width setting
		PAN	Enables panning to one side or the other.
			SIDE - Sidechain compressor specific to the reverb output
SATuration	SATURATION	Distortion effect	
DECIimation	DECIMATION	Decimation distortion effect	
CRUSH	BITCRUSH	Distortion bitcrusher	

4 Synthesizer

Function	Sub Category Parameter	Quick Button Access	Options & Description
	VOLUme	VOL DUCK	Amount the sidechain compressor affects the sound volume creating ducking. Also configurable to patch / connect as modulation.
	SYNC	SYNC	Time interval to sync the sidechain compressor or OFF. Options 4 bar, 2 bar, 1 bar, 2 nd , 4 th , 8 th , 16 th , 32 nd , 64 th
SIDEchain	ATTACK	ATTACK	Attack - ramp up time of the compressor
Sidechain Compressor	RELEase	RELEASE	Release - ramp down time of the compressor release
	SHAPE	SHAPE	Adjust the shape of the compressor to add more punch or reduce the transient effect for a more gentle subtle sound
	SEND	SEND	Kit sounds only. Level this current sound triggers all of the other sidechain compressors in other sounds.
bEnd	NORM		Normal pitch bend range in semitones for the Synth or CV clip. Typically this is the pitch bend wheel of a controller.
Bend range	MPE		MPE pitch bend range in semitones for the Synth or CV clip. Typically this using two finger MPE expression. Default 48.
VOLUme		LEVEL (Master)	Level of the clip
Output Level Setting			
PAN		PAN	Left / right balance of the sound. 32L - 0 - 32R
Output Balance			
dirE		DIRECTION (may not be labelled)	Playback direction of sequencer. Forward, Reverse or PingPong.
Direction			

4.7 Creating a New Synthesizer

Upon start up, the Deluge is loaded with a synth clip and default patch, however the option exists to to create a new synthesizer clip at anytime.

■ CREATING / LOADING A NEW SYNTHESIZER CLIP

1. Press [CLIP] to select clip view. This is indicated by the clip button illuminated blue.
2. Press [SHIFT] + [SYNTH] to create a synth clip.
3. A new blank clip and subtractive square wave synth will be created and added at the end of the preset list. For example, If the last preset is 170, the new synth preset will be created as 171.

■ CREATING A NEW SYNTHESIZER ROW IN A KIT CLIP

1. Press [CLIP] to select clip view. This is indicated by the clip button illuminated blue.
2. When in the KIT view, kit button lit red, a blank square wave synth can be added to a row.
3. Press [AUDITION] + [SYNTH] to create a synth clip on the row selected by the AUDITION pad.

■ ADJUSTING A SYNTH CLIP COLOUR

1. Press [SYNTH]. The button illuminates red.
2. Press & hold [SHIFT] + turn (SCROLL ▼ ▲).
3. Colour will change as the (SCROLL ▼ ▲) is adjusted. Release control and buttons when the colour is selected.

4 Synthesizer

■ SELECTING FM, RING MOD OR SUBTRACTIVE SYNTHESIZER

1. Press [CLIP] to select clip view. This is indicated by the clip button illuminated blue.
2. Select a synth by pressing [SYNTH] if not already selected. The synth button illuminates red. A new synth clip can also be created which defaults to a subtractive synth mode using [SHIFT] + [SYNTH].
3. Press (SELECT) to enter the sound editor.
4. Turn (SELECT) navigate to select MODE : 'mode' in-focus.
5. Press (SELECT) to enter the MODE sub-menu and navigate by turning (SELECT) to select the synthesiser model to use:
 - SUBtractive (default)
 - rinG Modulation (technically subtractive)
 - FM
 - Wavetable synths are not selectable directly in this mode, but are accessible by the subtractive option. Also set by assigning WAVE as the Type in an Oscillator
6. Use [BACK / UNDO] to exit after changing mode. The [BACK / UNDO] button flashes red to indicate that the backup option is available.

CREATING A WAVETABLE SYNTHESIZER

1. Press [CLIP] to select clip view. This is indicated by the clip button illuminated blue.
2. Create synth by pressing [SHIFT] + [SYNTH]. The synth button illuminates red.
3. Press [SHIFT] + [BROWSE] for SAMPLE 1. The button flashes white. Sample 1 will apply to Oscillator 1. Both Oscillators can be setup as a wavetable synth.
4. The display indicates 'bot-toP' to suggest that an audio file loaded will be applied across the entire note range, bottom to top. Wavetables can be assigned to user selected note ranges, but these cannot be mixed with samples and waveforms together across multiple note ranges.
5. Press (SELECT) to select the entire note range and open the browser.
6. Navigate the SD card files to select the wavetable to load. Press (SELECT) to load the desired wavetable file.
7. Ideally an audio file formatted to a wavetable standard should be used. Deluge will recognise wavetable formatted files and will therefore assign TYPE as WAVETable to the Oscillator 1 automatically.
8. If a file is loaded that is not in a wavetable format it will still load and Deluge will make assumptions on the format, cycle size etc. As such this may not behave or sound like a typical wavetable but nevertheless still delivers interesting results.
9. The main wavetable specific parameter to control and set up is the wave navigation and is called WAVETABLE accessed from within the oscillator menu, the wavetable shortcut pads or CUSTOM 2 for Osc1 and CUSTOM 3 for Osc 2. This sets the wave position and interpolation for the cycle used by the oscillator. Modulating this parameter can give interesting results, especially for both oscillators.

Wavetable

A file with a series of wave cycles. The 'wavetable' parameter navigates and selects the cycle used in the Oscillator

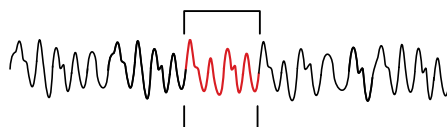

Wavetable Position

As well as from the shortcut pad, the wave position is adjusted using CUSTOM 2 when Oscillator 1 is set to a wavetable synth and CUSTOM 3 for Oscillator 2. If Only Osc 1 is a wavetable synth, CUSTOM 3 controls LFO2 depth modulating the Osc 1 wave position.

4 Synthesizer

4.8 Sound Editor - Synthesizer Parameters

NOTES

The commonly accessible parameters for clips are available from the eight 'affect parameter' controls. A more detailed parameter set are available within Deluge. Accessing and editing the synth parameters of the currently selected synth clip can be performed using the sound editor nested menu option or via the quicker grid shortcuts option.

Sound Editor: Nested Menus

Nested menus provide access to the full parameter set available.

Press (SELECT) opens up access to the sound editor nested menu and full parameter set.

Press (SELECT) to select the option in-focus on the display.

Turn (SELECT) to navigate the nested menu or change the parameter in-focus / displayed.

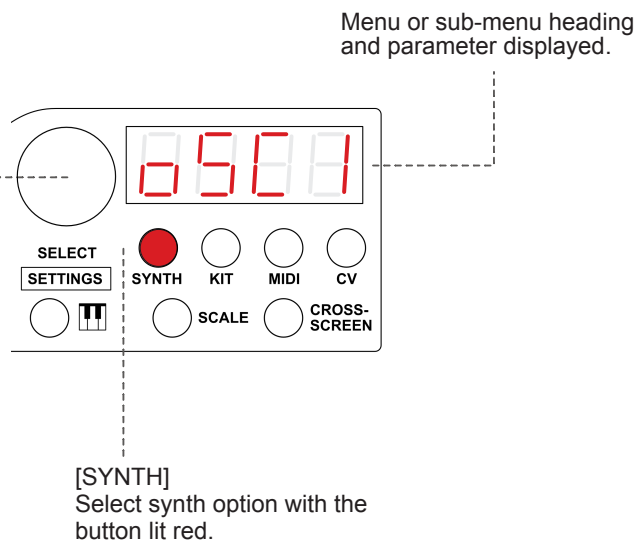

Example menu navigation.

Press (SELECT) to access sound editor

Press (SELECT) to drill down or turn (SELECT) to scroll through menu.
Oscillator 1 : Osc 1.

Press (SELECT) drill down or turn (SELECT) to scroll menu.
Osc 1 : Volume - 'VoLU'

Turn (SELECT) to edit the parameter
Osc 1 : Volume - 'VoLU' : 50

Press [BACK / UNDO] to back up the menu structure - flashes red when available.

Grid shortcut pad for function flashes white when in-focus for editing.



SOUND EDITOR: EDITING PARAMETERS IN NESTED MENUS

1. Press [CLIP] to select clip view. This is indicated by the clip button illuminated blue.
2. Select synth by pressing [SYNTH] if not already selected. The synth button illuminates red.
3. Press the (SELECT) rotary control.
4. The first function at the highest menu level will appear, for example oscillator 1 labelled in the 4-digit display 'oSC1'.
5. The [BACK / UNDO] button flashes red to indicate that the backup option is available. Pressing [BACK / UNDO] will move a step back in the menu.
6. Turning (SELECT) navigates other menu functions at the top level.
7. With the selected option i.e. 'oSC1' in focus, press (SELECT). This will step down a menu branch level within the selected parameter to access its sub functions. Number of levels in menu are dependant on the function.
8. Turning (SELECT) navigates the sub-menu option if available or to a parameter. Press (SELECT) when the desired function is in-focus, i.e. 'TYPE' within the oscillator sub menu.
9. When the editable options appear the respective grid shortcut button will flash white i.e. TYPE.
10. Turn (SELECT) to change the parameter option or value in-focus. For oscillator, type this will be the available waveforms i.e. SAW, SIN etc.
11. Use [BACK / UNDO] to back out of the menu when the parameter has been changed.
12. Continue to edit through the menu and set other parameters as desired.
13. When preset parameters have all been changed to suit your requirements it is recommended to save the preset. Press [SAVE] + [SYNTH] to save the preset.

4 Synthesizer

Sound Editor: Grid Shortcuts

Grid shortcuts are the quicker of the sound editing access options. Using these, synth parameter's can be accessed directly with a single set of key strokes.

Press [SHIFT] + [PAD] or Press [AUDITION] + [PAD] where PAD is the specific function and parameter.

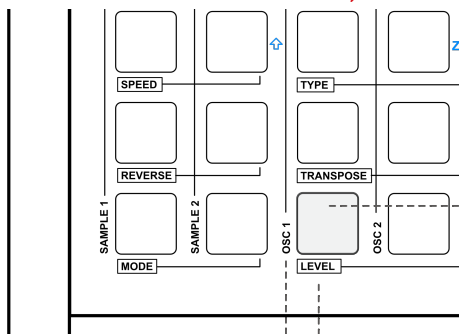
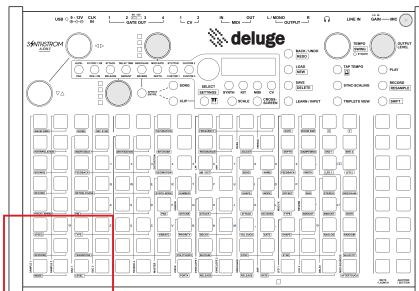

Lines extend across pads where the function applies i.e. type for osc 1 & 2 and FM mod 1 & 2.

Grid shortcut pad for function flashes white when in focus for editing.

Press [BACK / UNDO] to cancel selection. Button flashes red when available.

Top level function i.e. oscillator 1 is labelled vertically for the column.

Actual parameter within the function i.e. volume level shown as the shift option under the button.

Display indicates the parameter setting / value immediately on selection of the function / parameter pad.

50

SOUND EDITOR: EDITING PARAMETERS USING SHORTCUTS

1. Press [CLIP] to select clip view. This is indicated by the clip button illuminated blue.
2. Select synth by pressing [SYNTH] if not already selected. The synth button illuminates red.
3. Press the [SHIFT] + [PAD] where *PAD* is the specific function and parameter. [AUDITION] + [PAD] also can be used. For example osc1, 3rd column from left includes all osc1 parameters. The parameter i.e. LEVEL is labelled under the pad .
4. The actual parameter setting or current will appear on the display, for example '50' for LEVEL and the pad for its value, flashes white.
5. If a parameter is not available, the message 'CANT' is displayed on the display. For example FM parameters cant be accessed in subtractive mode.
6. Turning (SELECT) adjusts the parameter setting or value.
7. Use [BACK / UNDO] to exit when the parameter has been changed. The [BACK / UNDO] button flashes red to indicate that the backup option is available.
8. Continue to edit through other settings and parameters as desired.
9. When the parameters have all been changed to suit your requirements it is recommended to save the preset. Pressing [SAVE] + [SYNTH] and [SAVE] again to confirm saves the preset.

If the display indicates 'SOON' when selecting a parameter with the shortcut pads, then this means a function is not implemented in this firmware version and is reserved for potential future implementation. If 'CANT' is displayed then the parameter isn't available for editing in the current mode or configuration.

4 Synthesizer

NOTES

Sound Editor: Parameter Editing

Editing the actual parameters in the nested menu or when selected with the shortcuts can be done generally, and where required can be finely tuned.

8850

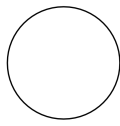

SELECT
SETTINGS

Turn the (SELECT) rotary to adjust a parameter setting. The display will show the value as its adjusted.

88.50

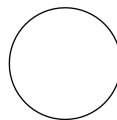
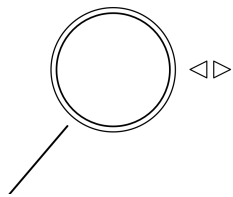

SELECT
SETTINGS

Some functions, for example transpose, have decimal values which can be fine tuned, at an individual digit level. Where this is applicable the digit in focus will flash and can be changed by turning (SELECT).

Use the (SCROLL ◀▶) control to select the digit in-focus to edit.

4.9 Oscillators

Deluge provides several oscillator types, set within the OSC1 & OSC2, TYPE Setting.

Digital Waveforms

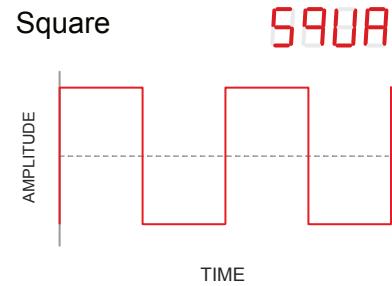
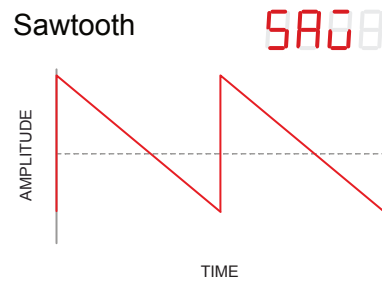
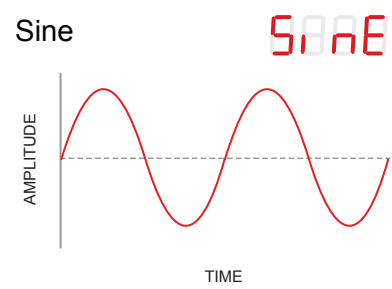
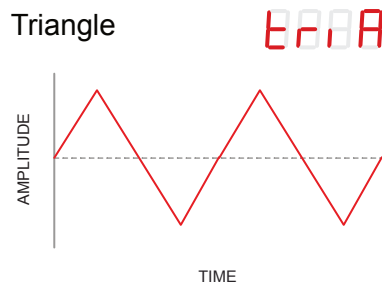

Analog Waveforms

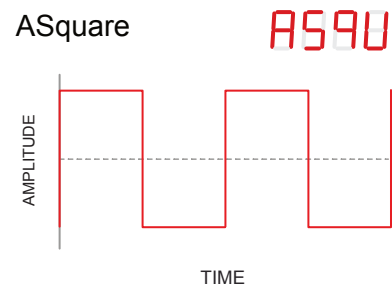
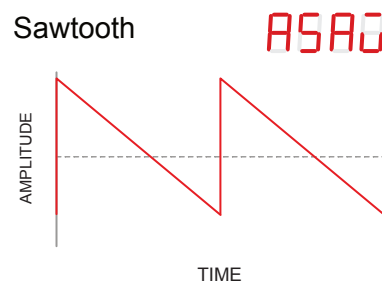

4 Synthesizer

Audio / Inputs as an Oscillator Waveform



In left/right, in right or in left, are automatically available when a physical line in is connected.

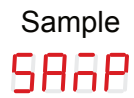

An audio sample can be used as the oscillator source. A series of sample specific options are available in the sound editor when SAMPLE is selected.



A wavetable file can be assigned to the oscillator source to create a wavetable synth. The main parameter is the wave position used by the oscillator. Navigation function of the wave is accessed in the oscillator options or via the keyboard shortcut.

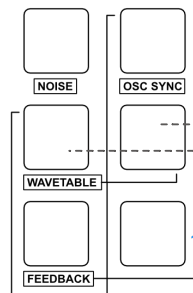

Wavetable navigation set per Osc. Available when Type is WAVETable.

NOTES

The ability to use a standard audio sample as an oscillator is also possible. While single cycles are also useful here, they are better applied in a wavetable synth.

■ USING A SAMPLE AS AN OSCILLATOR WAVEFORM SOURCE

1. Press [CLIP] to select clip view. This is indicated by the clip button illuminated blue.
2. Select synth by pressing [SYNTH] if not already selected. The synth button illuminates red.
3. Press [SHIFT] + [TYPE] as quick access shortcut for OSC1 or 2. Alternatively use the nested menu options by pressing (SELECT) and navigating to 'tYPE'.
4. Turning (SELECT) navigates the waveform options. Select 'SAMP' in-focus.
5. Use [BACK / UNDO] to exit sub-menu and back up a level. A new set of parameters, made available by selecting the SAMPlE option are now accessible.
6. Select a sample by navigating to 'FiLE' by turning (SELECT).
7. Pressing (SELECT) while FiLE is in focus opens the option to browse and select a sample, 'bot-toP' will scroll on the display to indicate the bottom-to-top note range.
8. Press (SELECT) to enter the sample browser. By default the factory folders for 'ArtiStS', 'drUMS', 'rECord', 'resample' are available which can be selected by turning and then pressing (SELECT) when the folder is in-focus.
9. Navigate samples and folders by turning (SELECT) and select the sample is in focus. The sample will audition and an illustration of the sample will be mapped across the grid.
10. Press (SELECT) to load the sample as the oscillator wave.

4 Synthesizer

4.10 Filters

NOTES

Deluge has a high-pass and low-pass filter.

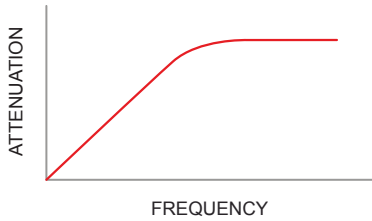

HPF - HIGH-PASS FILTER

Allows higher frequencies to pass through the filter and cuts off lower frequencies.

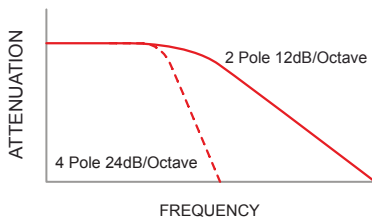

LPF - LOW-PASS FILTER

Allows lower frequencies to pass through the filter and cuts off higher frequencies. Deluge filters are 2-pole and 4-pole and 4-pole analog drive with saturation only on the LPF. Poles refer to how 'steep' or aggressive the cutoff curve is. This is measured in dB per octave.

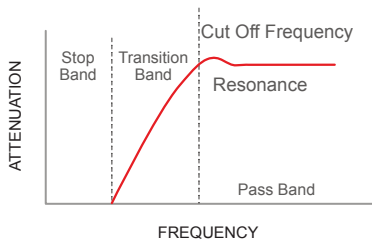

CUTOFF & RESONANCE

The two parameters common to both the filters provide control over the cutoff frequency and also the resonance (emphasis at the cutoff point).

4.11 Deluge Voices

A voice can be explained as a single signal path used by synthesizers, and is closely related to a synth's polyphony. Generally speaking the number of notes played simultaneously would count for the number of voices - although modes such as arpeggiation override how voices are assigned, and unison will sound multiple voices per note. Deluge's maximum voice count relies on the CPU loading and processing power available, but around 64 is the limit for most basic synth sounds.

SETTING THE SYNTH POLYPHONY

1. Press [CLIP] to select clip view. This is indicated by the clip button illuminated blue.
2. Select synth by pressing [SYNTH] if not already selected. The synth button illuminates red.
3. Using the shortcut option press [SHIFT] + [POLYPHONY]. Alternatively use nested menus by pressing (SELECT) and then turning (SELECT) to navigate to POLYphony sub-menu option within the VOICE menu.

Options are:

- POLYPHONY : Can play multiple notes simultaneously such as when playing chords and complex arpeggios,
 - MONOPHONIC : Set to play single notes, for example bass lines.
 - AUTO : Primarily monophonic but allows chords to be played.
 - LEGATO : Enables multiple notes to play as tied or connected. This is where notes can be played before a previous note is released.
 - CHOKE : Sets up choke groups when using kits to stop playing one sound when another is played. For example hi-hats closed and open wouldn't be played simultaneously in real world scenarios.
4. Select the priority when in polyphonic mode using [SHIFT] + [PRIORITY] or using nested menu option by pressing (SELECT) and then turning (SELECT) to navigate to PRIOrity sub-menu option within the VOICE menu.
 5. Set priority option for the current synth sound to low, medium or high. Deluge will release voices with lower priority first when CPU loading necessitates.
 6. Use [BACK / UNDO] or tap any grid pad once to exit sub-menu and back up a level or to back out of the sound editor.

4 Synthesizer

Unison Mode

NOTES

Unison mode enables a number of voices to be triggered by one note. By detuning these voices, rich and thick chorus-like sounds can be created.

Note on

Single note triggers multiple voices instead of the single default voice allocation.

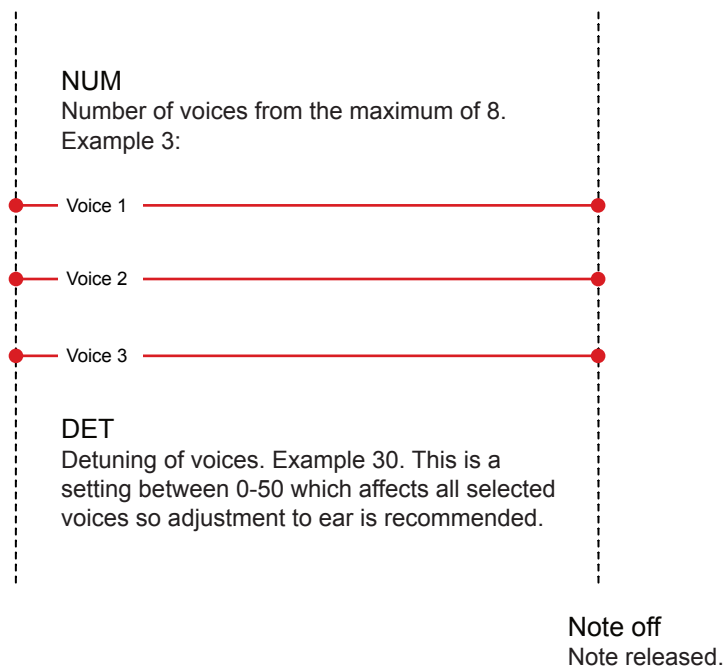

Deluge Unison

The settings available in the voice menu of Deluge include number of voices and the detuning of these voices. You can also use the two oscillators both detuned from each other in addition to unison mode.

Multiple instances of polyphonic and unison clips are possible under powerful CPU control. As the CPU becomes more loaded voices will be reduced starting with notes in a 'release' state and the priority setting found within the voice : polyphony parameter set.

SETTING THE SYNTH UNISON

1. Press [CLIP] to select clip view. This is indicated by the clip button illuminated blue.
2. Select synth by pressing [SYNTH] if not already selected. The synth button illuminates red.
3. Using the shortcut option press [SHIFT] + [NUMBER] in the UNISON section. Alternatively use nested menus by pressing (SELECT) and then turning (SELECT) to navigate to UNISON sub-menu option within the VOICE menu.
4. Adjust the NUM parameter by turning (SELECT). NUM : Number of voices, up to a maximum of 8, played simultaneously when one note is played.
5. Using the shortcut option press [SHIFT] + [DETUNE] in the UNISON section. Alternatively use nested menus by pressing (SELECT) and then turning (SELECT) to navigate to UNISON sub-menu option within the VOICE menu.
6. Adjust DET parameter by turning (SELECT). 'DETune' : A value between 0-50 that adjusts and detunes the voices from the original note giving a lush chorus style effect and thickens individual notes.
7. The audition pads can be used to listen in to the sound as it takes shape and also multiple notes can be played as chords on these pads.
8. Use [BACK / UNDO] or tap any grid pad once to exit sub-menu and back up a level or to back out of the sound editor.

4 Synthesizer

4.12. Arpeggiator

Each synth clip contains an arpeggiator. The arp settings are contained in the voice section of the sound editor parameters. An arp automatically steps through a sequence of notes and across octaves in a pre-defined way. By default the arp is off for most factory synth presets, and new synth instruments created.

OCTAVE
Arp will operate across the OCTAVes set. 1 octave will repeat the same note, same octave. 3 octaves will trigger 3 steps, each an octave apart.

MODE
Up, down, both, random or off

<input type="checkbox"/> <input type="checkbox"/> <input checked="" type="checkbox"/> <input type="checkbox"/>	<input checked="" type="checkbox"/> <input type="checkbox"/> <input type="checkbox"/> <input type="checkbox"/>	<input checked="" type="checkbox"/> <input type="checkbox"/> <input type="checkbox"/> <input type="checkbox"/>	<input checked="" type="checkbox"/> <input type="checkbox"/> <input type="checkbox"/> <input type="checkbox"/>	<input type="checkbox"/> <input type="checkbox"/> <input type="checkbox"/> <input type="checkbox"/>
<input type="checkbox"/> <input checked="" type="checkbox"/> <input type="checkbox"/> <input type="checkbox"/>	<input type="checkbox"/> <input checked="" type="checkbox"/> <input type="checkbox"/> <input type="checkbox"/>	<input type="checkbox"/> <input checked="" type="checkbox"/> <input checked="" type="checkbox"/> <input type="checkbox"/>	<input type="checkbox"/> <input type="checkbox"/> <input type="checkbox"/> <input checked="" type="checkbox"/>	<input type="checkbox"/> <input type="checkbox"/> <input type="checkbox"/> <input type="checkbox"/>
<input checked="" type="checkbox"/> <input type="checkbox"/> <input type="checkbox"/> <input type="checkbox"/>	<input type="checkbox"/> <input type="checkbox"/> <input checked="" type="checkbox"/> <input type="checkbox"/>	<input type="checkbox"/> <input type="checkbox"/> <input checked="" type="checkbox"/> <input type="checkbox"/>	<input type="checkbox"/> <input checked="" type="checkbox"/> <input type="checkbox"/> <input type="checkbox"/>	<input type="checkbox"/> <input checked="" type="checkbox"/> <input checked="" type="checkbox"/> <input type="checkbox"/>
UP	down	both	rAnd	off

Audition Pads

<p>Example: up/down, 16th note sync, 3 octaves</p>	<p>Example: up, 8th note sync, 2 octaves</p>
---	---

SYNC
Sets the trigger interval for the arp notes played within the sequencer or manually.

Shows 16th notes which will trigger a note in this example, at each step on a 16th Grid. Every 2nd step with a 8th note sync setting, 1 bar, once per bar, etc...

RATE
Sets the speed of the arpeggiator when SYNC is off.

GATE
The amount of time the arp note is played within the available time division.

Range is 0 - 50, where 50 will take up the entire time slot and 25 will be 50% of the note division. Examples with 8th notes.

5	<input checked="" type="checkbox"/> <input type="checkbox"/> <input type="checkbox"/> <input type="checkbox"/> <input type="checkbox"/> <input type="checkbox"/> <input type="checkbox"/> <input type="checkbox"/> <input type="checkbox"/>
12	<input checked="" type="checkbox"/> <input type="checkbox"/> <input type="checkbox"/> <input type="checkbox"/> <input checked="" type="checkbox"/> <input type="checkbox"/> <input type="checkbox"/> <input type="checkbox"/>
25	<input checked="" type="checkbox"/> <input checked="" type="checkbox"/> <input type="checkbox"/> <input type="checkbox"/> <input checked="" type="checkbox"/> <input checked="" type="checkbox"/> <input type="checkbox"/> <input type="checkbox"/>
50	<input checked="" type="checkbox"/> <input checked="" type="checkbox"/> <input checked="" type="checkbox"/> <input checked="" type="checkbox"/> <input checked="" type="checkbox"/> <input checked="" type="checkbox"/> <input checked="" type="checkbox"/> <input checked="" type="checkbox"/>

SETTING THE ARPEGGIATOR

1. Press [CLIP] to select clip view. This is indicated by the clip button illuminated blue.
2. Select synth by pressing [SYNTH] if not already selected. The synth button illuminates red.
3. Using the shortcut options to access the arp parameters directly, e.g. press [SHIFT] + [MODE]. Alternatively use nested menus by pressing (SELECT) and then turning (SELECT) to navigate to ARPEggiator sub-menu option within the VOICE menu.

Options via the menu or directly from the [SHIFT] + shortcuts are:

- MODE : pattern style: up, down, both, random or off for arpeggios.
 - SYNC : Sets the time interval of the sync for the arpeggiator or OFF to deactivate tempo sync. Options are 4 bar, 2 bar, 1 bar, 2nd notes, 4th notes, 8th notes, 16th notes, 32nd notes and 64th notes.
 - OCTAVES : Sets the range of the arpeggiator notes.
 - GATE : Sets the percentage that the note trigger will fill with respect to the available time divisions.
 - RATE : Sets the arpeggiator rate when sync is off.
4. Ensure any sequence timing and steps are taken into account when setting the arpeggiator sync and gate.
 5. Use [BACK / UNDO] or tap any grid pad once to exit sub-menu and back up a level or to back out of the sound editor.

4 Synthesizer

4.13 Single-cycle Waveforms

NOTES

Deluge provides several oscillator types but also can take an audio input or audio wave file as its 'oscillator'. Single-cycle waveforms are best used in a wavetable synth which are then processed in Deluge to create unique and creative oscillator sound source. Single-cycles can be used as a sample but the wavetable synth carries better performance when processing single cycles. If samples are not compatible with the wavetable engine (i.e. stereo) it will load as a sample. The wavetable navigation parameter is not available for single cycles.

Single-cycle Waveform

Native (preferred) 44.1kHz 16/24bit.
WAV or AIFF up to 32bit 96kHz.

Deluge will interpret any audio file less than 20ms and when loaded in the synth as a single-cycle waveform.

Wavetable (preferred)
or Sample

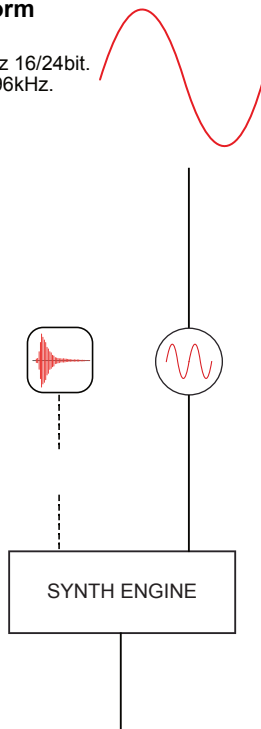

The synth engine will automatically set single-cycle waveforms to an oscillator pitch transpose to represent note 'C' and set the waveform to loop.

'C'

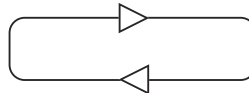

Deluge can also be 'forced' to load waveforms above 20mS as single-cycle waveforms.

LOADING A SINGLE CYCLE WAVE AS AN OSCILLATOR

1. Ensure the SD card has short single-cycle waveforms. These should be 20ms or shorter. Longer ones can be forced to load.
2. Press [CLIP] to select clip view. This is indicated by the clip button illuminated blue.
3. Select synth by pressing [SYNTH] if not already selected. The synth button illuminates red.
4. Press the [SHIFT] + [TYPE] as quick access to shortcut for OSC1. Alternatively use the nested menu options by pressing (SELECT) and navigating to 'TYPE'.
5. Press (SELECT) to Select TYPE and turn (SELECT) to navigate to select 'WAVE'.
6. Use [BACK / UNDO] to exit and back out.
7. Pressing (SELECT) choose Osc1 (or Osc 2) and press (SELECT) again.
8. Turn (SELECT) to navigate to 'FILE'..
9. Pressing (SELECT) while 'FILE' is in-focus will open the option to browse and select a sample, 'bot-toP' will scroll on the display to indicate the bottom-to-top note range for the sample.
10. Press (SELECT) again to enter the sample browser.
11. Navigate samples and folders by turning (SELECT) and select the folder containing the single-cycles. Highlight the wave to select in focus. The sample will audition and an illustration of the sample will be mapped across the grid.
12. To force loading a longer (>20mS) sample as a single-cycle press & hold (SELECT) to bring the synth context menu options up:-
 - SINGLe : forces single-cycle load.
 - MULTIsamples : all folder samples.
 - BASIc : basic mode where no pitch analysis or or single cycle setting.
12. Press (SELECT) to load the sample as the oscillator wave.

————— KITS —————

5 Kits

5.1 Kit Creation Workflow

NOTES

An example high level workflow on setting up the Deluge kit gives a starting point for kit-based sound design.

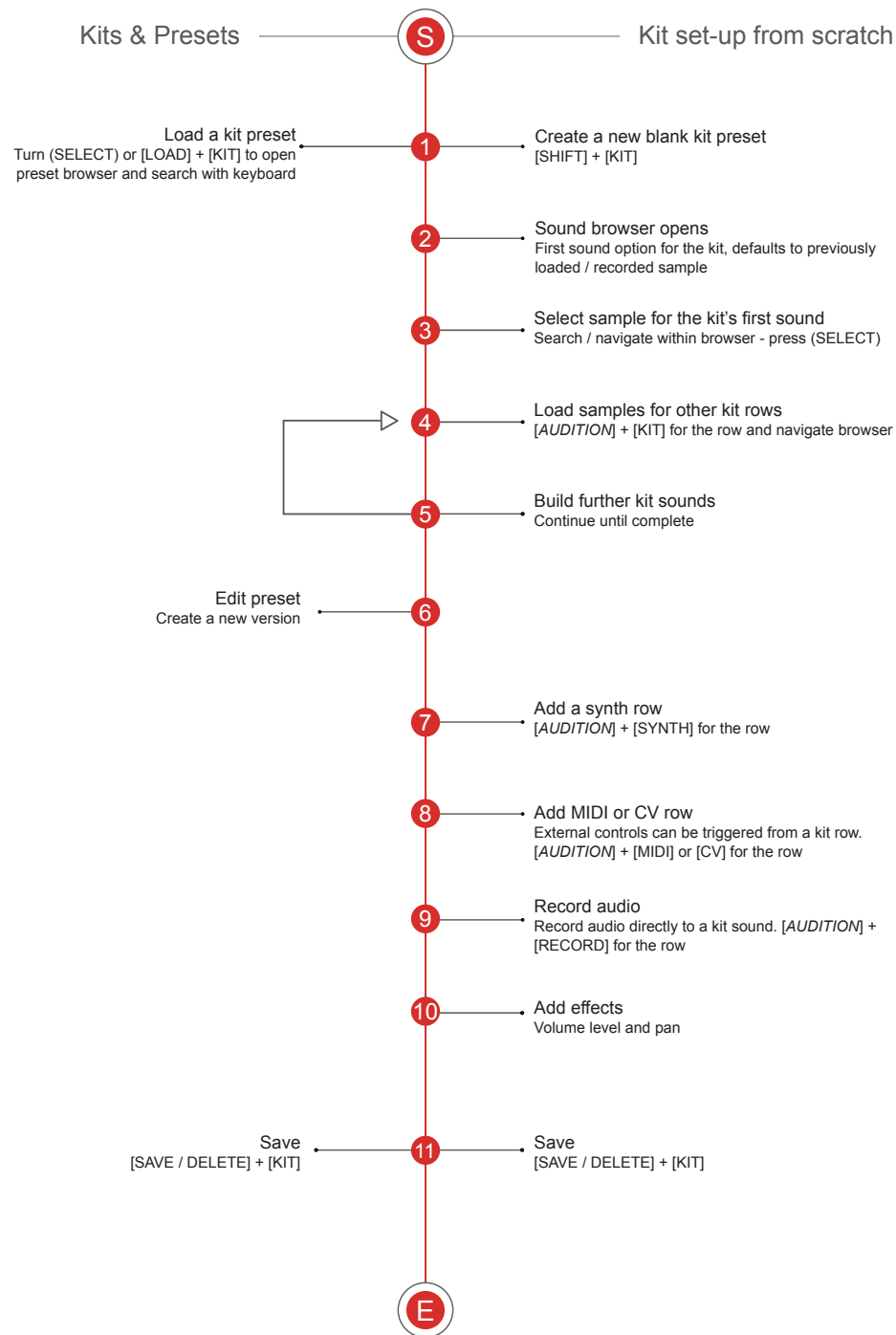

5.2 Kit Basics

If synth clips mainly support melodic elements with the ability for sample use, kits would more often be used with samples as the primary elements. Kits are used to form step patterns across the grid columns. These sounds can be samples, a synth, audio or even MIDI and CV. Unlike a synth which provides a sequenced melody, kits are used to typically generate a rhythm, maybe for drums or percussion or any other sequenced element.

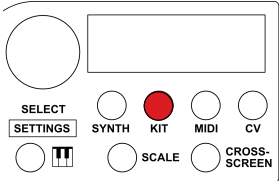

Notes to trigger the kit's sounds are recorded or programmed into the step sequencer. Programming is done by pressing a pad to toggle it on (lit) / off (unlit).

In play mode, pressing pads will silently enter the step; when not in play mode, pads will additionally audition the sound when selected.

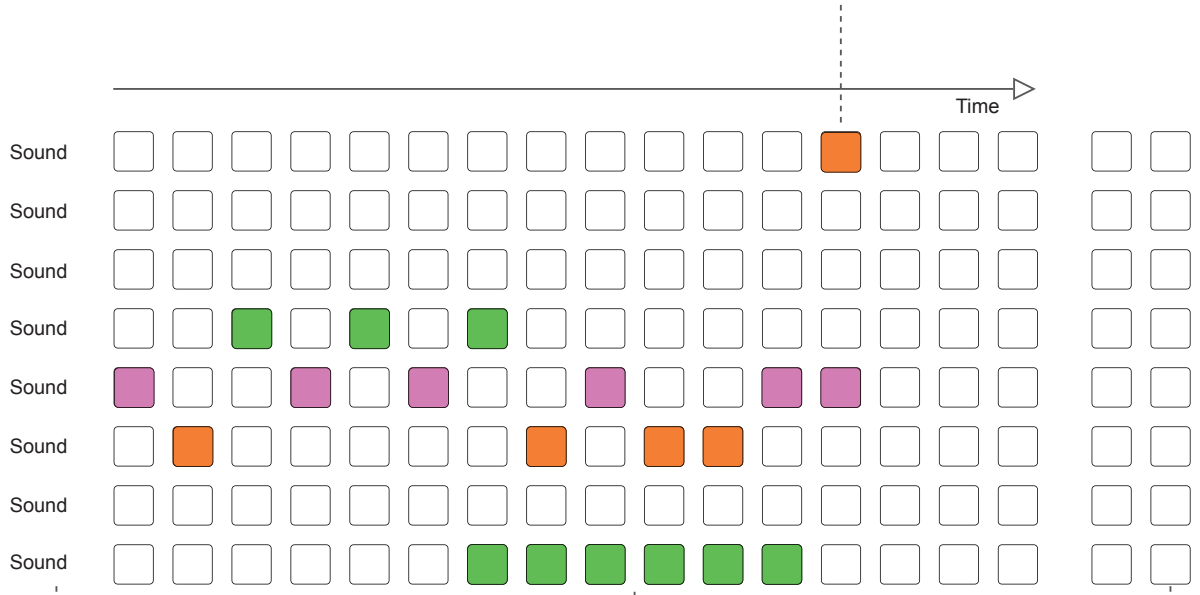

Individual sounds per row. Typically samples but also synth-based sounds, or MIDI / CV outputs.

Beats and loops as opposed to single 'hits' can also be used. Any loops in the factory kit is set to time stretch to the current Deluge tempo. These samples will extend beyond a single pad to match its length. Clips may extended to match longer loops.

Audition pad to play the sounds.

SELECTING KIT VIEW

1. Press [KIT]. The button illuminates red.
2. Scale and keyboard view are not available for kits.
3. The default kit preset loaded is '0'.
4. Some sounds may be off grid and can be brought into view with the (SCROLL ▼ ▲) control.
5. Rows which do not contain a sound will be indicated with an unlit [MUTE] pad. [MUTE] will be illuminated for rows containing sounds.

SELECTING A SOUND ROW

1. Press [KIT]. The button illuminates red.
2. Press [AUDITION] for the respective row to play and select. Sound name will display while pad is pressed.
3. The sound will play out and the audition pad will illuminate dim to indicate that the row and hence the sound is selected. Press [SHIFT] + [AUDITION] to select the row silently.
4. Selected sounds can be edited, replaced etc as individual rows.

ADJUSTING A KIT ROW COLOUR

1. Press [KIT]. The button illuminates red.
2. Press & hold [SHIFT] + [AUDITION] for the respective row to change and turn (SCROLL ▼ ▲).
3. Colour will change as the (SCROLL ▼ ▲) is adjusted. Release control and buttons when the colour is selected.

Many features that are available in synth view are also available in kit view. These include the parameter affect group, mute and audition pads. Generic sequencer grid functions apply both to synth and kits.

RE-ORDERING KIT ROWS IN THE SEQUENCER

1. Press [KIT]. The button illuminates red.
2. For the row to re-order. Firstly, press & hold [AUDITION] then press & hold [MUTE].
3. While still holding both of the [AUDITION] and [MUTE] buttons, turn (SCROLL ▼▲).
4. The row will be relocated to the new location and other rows repositioned to match the change.

ADJUSTING AFFECT PARAMETERS FOR KITS

1. Press [KIT]. The button illuminates red.
2. Press [AUDITION] to select the row sound.
3. The sound will play out and the audition pad will illuminate dim to indicate that the row and hence the sound is selected. [SHIFT] + [AUDITION] for silent selection.
4. Selecting the desired parameter, for example: [LEVEL / PAN].
5. Turn the (UPPER) - level or the (LOWER) - pan, control to change the selected parameter for the row sound selected.
6. To change all kit sounds in the clip, press [AFFECT ALL]. Change parameters as per steps 5-6 above. The selected parameter for ALL clip sounds are adjusted collectively.

Just a few of the sound editor settings have the ability to be edited in bulk for all sounds within a kit. These are POLYphony, sample MODE, REVERse, SPEEd, and PISP (pitch / speed). When editing any of these, you may hold down the affect-entire button while turning the select knob in order to have your edit applied to all sounds within your kit.

5 Kits

5.3 Kit Presets & Samples

NOTES

A kit consists of a number of sounds typically based on samples, also synth, MIDI, CV and audio and are stored as a collection within a kit. This is formatted as a sound per row of the grid.

CREATING A NEW BLANK KIT CLIP

1. Press [CLIP] to select clip view. Clip button illuminates blue.
2. Press [SHIFT] + [KIT] to create a kit clip.
3. A new blank kit is created and the file browser opens in order to choose the first sample, example: *808 ConGA HiGH* from the DRUM library in the SAMPLES folder.
4. Press a blank [MUTE] button to quickly exit. Alternatively press [BACK / UNDO] to back up through the menu until the file browser is exited.
5. Blank kit is created and the preset name created is displayed.

CREATING A NEW KIT CLIP + SAMPLE

1. Press [CLIP] to select clip view. Clip button illuminates blue.
2. Press [SHIFT] + [KIT] to create a kit clip.
3. A new blank kit is created and the file browser opens in order to choose the first sample, example: *808 ConGA HiGH* from the DRUM library in the SAMPLES folder.
4. The sample name is scrolled on the display, the first open row is selected: [MUTE] and [AUDITION] both pad buttons illuminate to show the row selected in-focus.
5. Turn (SELECT) to navigate other samples if required.
6. Press (SELECT) to load the sample to the row selected.
7. Deluge will return to clip view and the file browser exited.
8. The sample can be auditioned and played by pressing the row [AUDITION] pad.

A synth, MIDI or CV row can be added in the kit view by pressing [AUDITION] + [SYNTH], [AUDITION] + [MIDI], [AUDITION] + [CV]

■ ADDING SAMPLES TO A KIT

1. Press [CLIP] to select clip view. Clip button illuminates blue.
2. Ensure a kit or blank kit is loaded.
3. Press [AUDITION] + [KIT], where the AUDITION is a pad.
4. The file browser opens in the SAMPLES folder in order to choose a sample, example: *808 ConGA HiGH* from the DRUM library.
5. Turn (SELECT) to navigate other samples if required.
6. Press (SELECT) to load the sample to the row selected.
7. Deluge will return to clip view and the file browser closed.
8. At any time when entering samples press [BACK / UNDO] to back up through the menu until the file browser is exits.
9. Repeat steps 3-8 above for adding additional samples.
10. Press [AUDITION] of each pad to view sample name in the display and play out the sound. Press [SHIFT] + [AUDITION] to select silently.

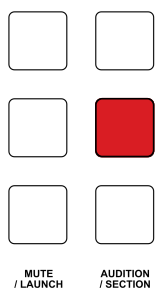

[KIT]
 [AUDITION] + or
 [LOAD]

To open the file browser for the specifically selected row via the audition pad. LOAD option brings parameters back to defaults when replacing an existing row sound.

The pad shortcut for the file browser [SHIFT] + [BROWSE] can also be used to replace a sample when the row is selected by its [AUDITION] Pad. When [BROWSE] option is used to replace an existing sound its parameters will be retained.

5 Kits

CREATING A NEW KIT CLIP + MULTIPLE (FOLDER) SAMPLES

1. Press [CLIP] to select clip view. This is indicated by the clip button illuminates blue.
2. Press [SHIFT] + [KIT] to create a kit clip.
3. A new blank kit is created and the file browser opens in order to choose the first sample, example: *808 ConGA HIGH* from the DRUM library in the SAMPLES folder.
4. The sample name is scrolled on the display, the first open row is selected: [MUTE] and [AUDITION] both pad buttons illuminate to show the row selected in-focus.
5. Navigate to a folder to load. [BACK / UNDO] will navigate back up the menu, pressing (SELECT) drills down. Select a folder in-focus to load, example: CLAVES.
6. Press & hold (SELECT) until a menu of options appears. This should indicate ALL, if not turn (SELECT) to select ALL.
7. Press (SELECT). Deluge will load the folder into the rows automatically.

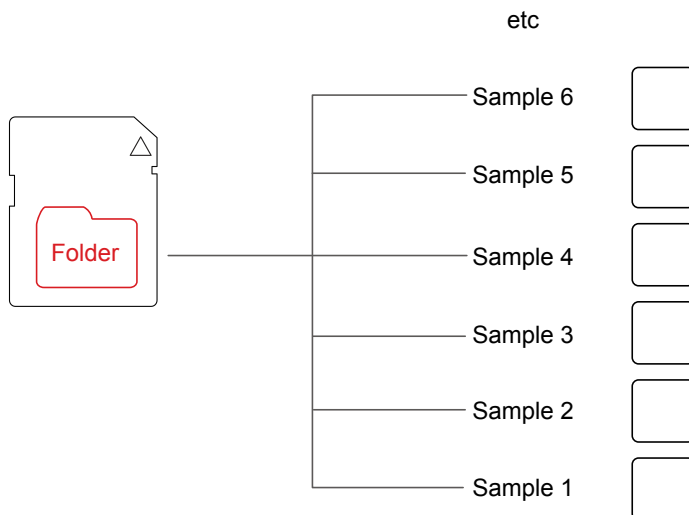

It is recommended to organise your samples in a folder that can be recognised in groups from the file browser and will load batches to in a reasonable size, for example 8 samples per folder.

■ ADDING A SYNTH-BASED SOUND TO A KIT

1. Select [CLIP] View and select a [KIT].
2. Press & hold [AUDITION] pad for the row which will convert to a synth + press [SYNTH].
3. Press [AUDITION] pad to play the kit row.
4. Set-up the synth parameters, such as oscillator wave, LPF etc as if creating a new synth sound or use the parameter controls. Also set the pitch.
5. Notes programmed into the row will trigger the synth. This method is ideal to play back longer audio pads.

■ RENAMING SOUNDS WITHIN A KIT

1. Press [CLIP] to select clip view. This is indicated by the clip button illuminated blue.
2. [KIT] ensure a kit is loaded.
3. Press [AUDITION] to select the row sound. The pad will illuminate.
4. Press [SHIFT] + [NAME].
5. The alphanumeric keyboard appears and the name flashes in the display. This enables typing in of a new name.
6. Press RETURN 'delay amount' [PAD] when typing of a new name is complete.

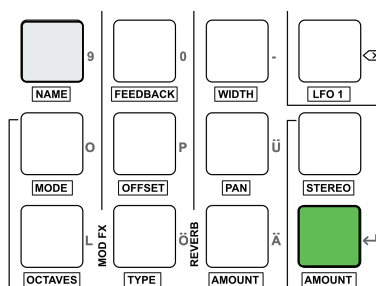

MODULATION

6 Modulation

6.1 Modulation Routing Basics

NOTES

Parameters within Deluge can be connected / patched to modulation sources. Multiple sources may modulate one parameter, and multiple parameters may be modulated by one source.

Modulation Source Shortcuts

There are several modulation sources which are available through the nested menu sound editor. They are also directly accessible from the grid.

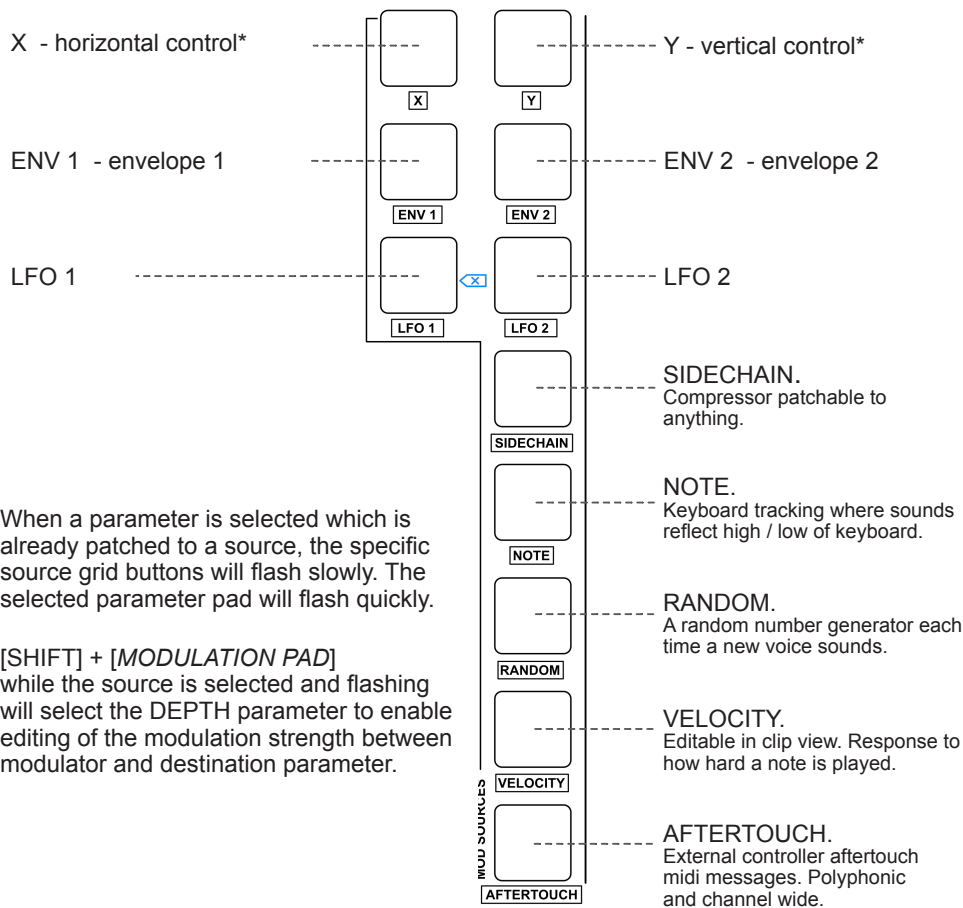

X & Y options not implemented on OS 3.0.

CONNECTING A SYNTH MODULATION SOURCE TO A PARAMETER

1. Press [CLIP] to select clip view. This is indicated by the clip button illuminated blue.
2. Select synth by pressing [SYNTH] if not already selected. The synth button illuminates red.
3. Press the [SHIFT] + [PAD] where *PAD* is the destination parameter to be modulated. Example is LPF : frequency.
4. Press the [SHIFT] + [PAD] where *PAD* is the modulation source from the right side grid columns. Example is LFO 1.
5. The two elements are now connected. The source pad flashes white, quickly. The destination flashes white slowly. Multiple sources and destinations can be patched and connected.
6. The display will show the strength of the connection which is the amount of modulation between the two functions. Turn (SELECT) to adjust. Depth can be positive and negative values. Non-zero value means a modulation connection exists.
7. Pressing [BACK / UNDO] will confirm and exit the option and back up. The value of the destination in this case LPF Frequency will be tagged to show a modulation source is connected.

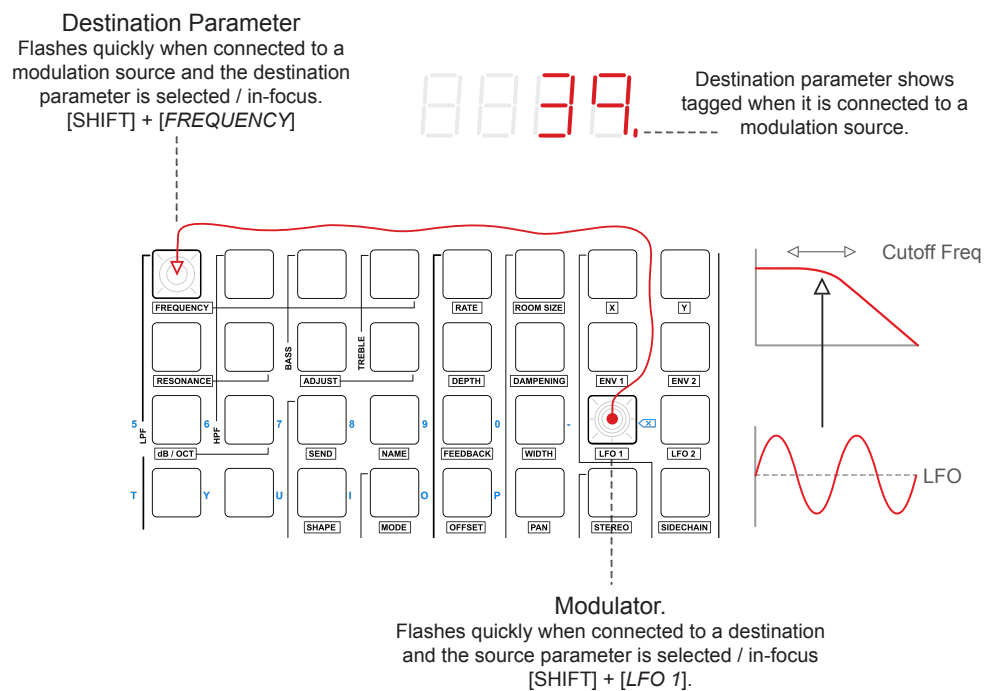

6 Modulation

Modulation Source Nested Menu

The option to use nested menus for modulation patching is also available. The grid will display the same characteristics of flashing destination and source pads when using shortcuts.

CONNECTING A SYNTH MODULATION SOURCE TO A PARAMETER

1. Press [CLIP] to select clip view. This is indicated by the clip button illuminated blue.
2. Select synth by pressing [SYNTH] if not already selected. The synth button illuminates red.
3. Press the (SELECT) to enter the sound editor menus.
4. Turn (SELECT) to select the destination parameter. Example is LPF.
5. Press the (SELECT) to drill down into the menu. Example is LPF : frequency. The title and value will show a tag bottom right in the display if a modulation source is already connected. The pad will flash quickly.
6. When the value is in-focus, press (SELECT) to drill down further into the menu structure and access the modulation options for the parameter in-focus.
7. Modulation options will be available. Turn (SELECT) to scroll and navigate the options. When the selected option, example LFO 1 is in-focus press (SELECT). The title will show a tag bottom right in the display if the destination source is already connected.
8. The display will show the strength of the connection which is the amount of modulation between the two functions. Turn (SELECT) to adjust.
9. A value other than '0' will create a modulation connection and the display parameter, example LPF: frequency will be tagged. The modulation pad will flash quickly and the parameter destination will flash slowly. Depth can be positive and negative values.

DELETING A SYNTH MODULATION CONNECTION

1. Press [CLIP] to select clip view. The clip button illuminates blue.
2. Select synth by pressing [SYNTH] if not already selected. The synth button illuminates red.
3. Select destination and source. Press the [SHIFT] + [PAD] where *PAD* is the destination parameter. Example is LPF : frequency.
4. Press the [SHIFT] + [PAD] where *PAD* is the modulation source. Example is LFO 1. Pads will flash and display shows connection.

Or

1. Use nested menu option to select destination parameter. Turn (SELECT) to select the destination parameter. Example is LPF.
2. Press the (SELECT) to drill down into the menu. Example is LPF : frequency. The title and value will show a tag bottom right in the display if a modulation source is already connected. The pad will flash quickly
3. When the value is in-focus, press (SELECT) to drill down further into the menu structure and access the modulation options for the parameter in focus.
4. Modulation options will be available. Turn (SELECT) to scroll and navigate the options. Modulated elements will be tagged. When the selected option, example LFO 1 is in-focus press (SELECT).

Then

1. The display will show the strength of the connection which is the amount of modulation between the two functions. Turn (SELECT) to adjust and set to '0'.
2. Pressing [BACK / UNDO] will confirm and exit the option and back up. The value of the destination in this case LPF frequency will be untagged to show a modulation source is not connected.



Destination parameter name and value and source name shows tagged when it is connected to a modulation source.



Destination parameter name and value and source name shows untagged when it is not connected to a modulation source.

6 Modulation

		MODULATION SOURCES											
		Global to Sound		Per Voice									
		Sidechain	LFO 1	LFO 2	ENV 1	ENV 2	Velocity	Note	Random	After Touch	X	Y	
PARAMETERS	Global to Sound	Delay Amount / Rate	✓	✓	No Modulation is Allowed								
		Mod FX Depth / Rate	✓	✓									
		Arpeggiator Rate	✓	✓									
		Reverb Amount	✓	✓									
		LFO 1 Rate	✓	✓									
	Both	Overall Volume	✓	✓	✓	Hard Connect		✓	✓	✓	✓	✓	✓
	Per Voice	LFO 2 Rate	✓	✓	✓	✓	✓	✓	✓	✓	✓	✓	✓
		Oscillator Volume	✓	✓	✓	✓	✓	✓	✓	✓	✓	✓	✓
		Noise Volume	✓	✓	✓	✓	✓	✓	✓	✓	✓	✓	✓
		Pitch / Transpose: Overall	✓	✓	✓	✓	✓	✓	✓	✓	✓	Hard Connect	✓
		Pitch / Transpose: Oscillator / FM Modulator	✓	✓	✓	✓	✓	✓	✓	✓	✓	✓	✓
		FM Modulator Level	✓	✓	✓	✓	✓	✓	✓	✓	✓	✓	✓
		FM Feedback	✓	✓	✓	✓	✓	✓	✓	✓	✓	✓	✓
		Pulse Width	✓	✓	✓	✓	✓	✓	✓	✓	✓	✓	✓
LPF / HPF Frequency / Resonance		✓	✓	✓	✓	✓	✓	✓	✓	✓	✓	✓	
ENV 1/2 ADSR		✓	✓	✓	✓	✓	✓	✓	✓	✓	✓	✓	
Pan		✓	✓	✓	✓	✓	✓	✓	✓	✓	✓	✓	
Wavetable Position	✓	✓	✓	✓	✓	✓	✓	✓	✓	✓	✓		

6.2 Modulation Routing Advanced

Multiple sources can modulate multiple parameters. In addition, modulation sources can also modulate other modulators creating complex and advanced patching systems. The same methodology applies in connecting parameters but must start with the destination. The modulation depth is where to drill down to further modulation options. Pads will flash showing the routing based on the selected in focus parameter.

Example 1:
LFO 2 modulates LFO 1 to modulate LPF : frequency cutoff.

Destination Parameter
Flashes quickly when connected to a modulation source and the destination parameter is selected / in-focus.
[SHIFT] + [FREQUENCY]

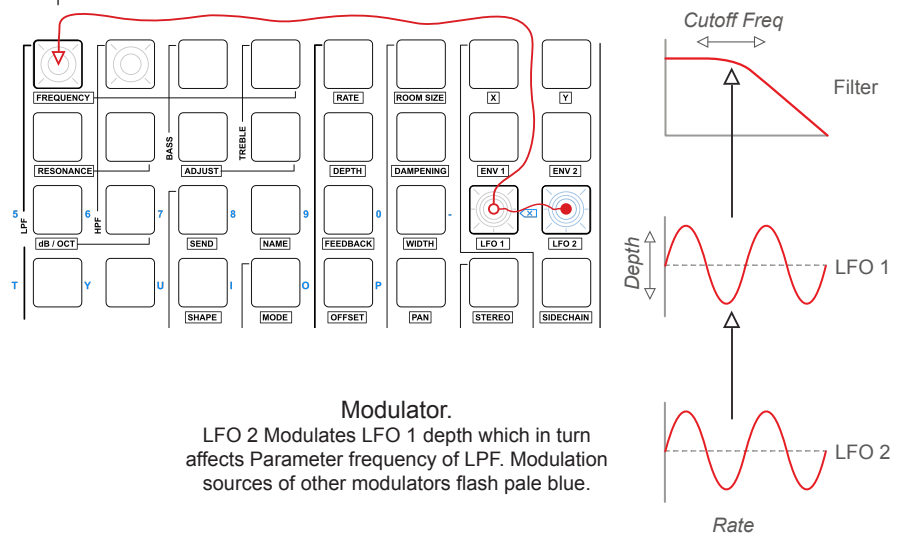

6 Modulation

Example 2:

As per example 1, plus also demonstrates multiple modulators LFO and ENV 1 to one destination parameter and multiple destinations of one modulator i.e. ENV 1. Follow the same process drilling down from the in focus modulator value to access available modulator options.

Destination Parameters
LFP frequency and resonance

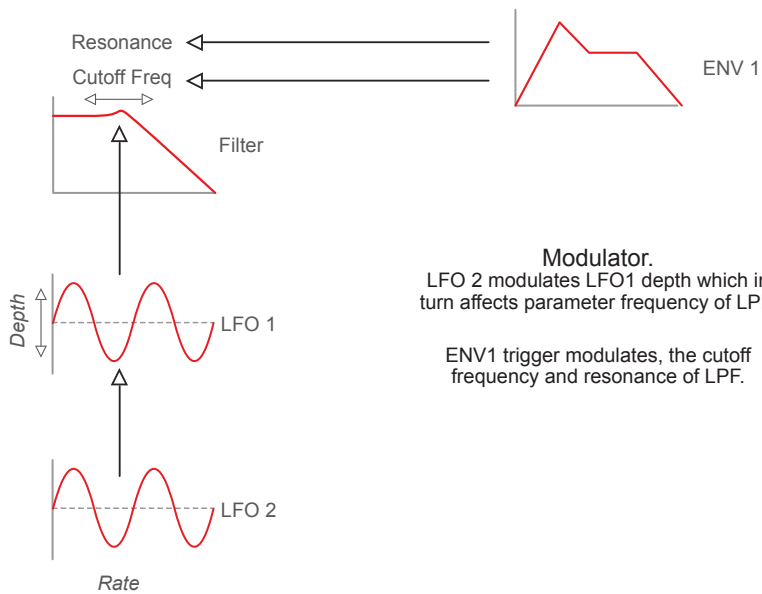
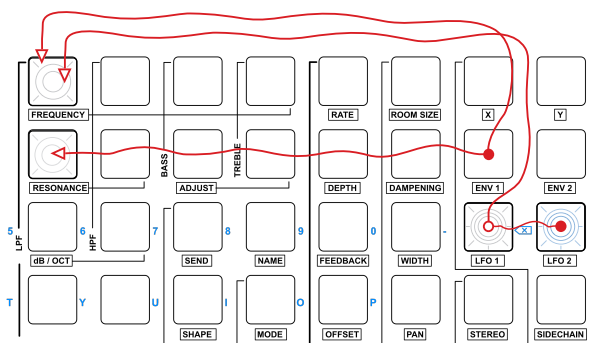

6.3 Envelopes and Low Frequency Oscillators

Envelopes are used to shape the sound typically over one cycle of the envelope. ENV1 controls volume amplitude by default. In addition it can be patched to other parameters. ENV2 has freely assignable destinations. The envelopes are traditional ADSR (attack, decay, sustain, release) type.

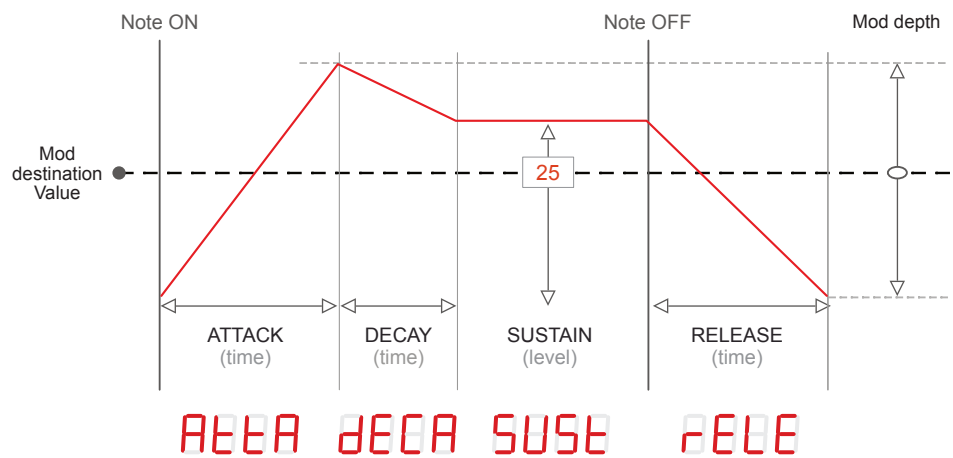

When either of the 2 envelopes modulate a parameter other than volume level, it does so with a 'bipolar' behaviour. This means that when the sustain is set to 25 (default for ENV2), that stage of the envelope will match the current setting of the target parameter without modulation. Sustain settings below 25 will then modulate the parameter lower than its current setting, also determined by mod depth. Bipolar behaviour affects all stages of the envelope but is most important when considering sustain level settings, as the others are time based.

6 Modulation

The LFO is a continuous modulation function. Wave options are Sine, Saw, Square or Triangle. LFO1 has an additional SYNC parameter to set a sync time interval or switch off. LFO1 does not retrigger and covers all voices. LFO2 is retriggerable and exists for each voice separately.

Triangle

TRIA

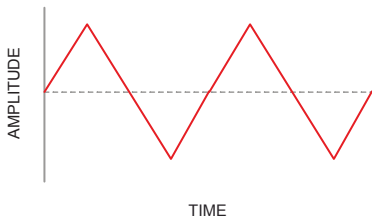

Sine

SINE

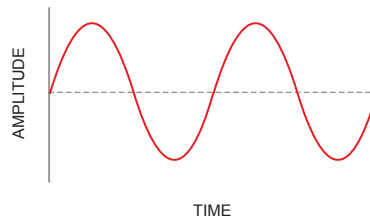

Sawtooth

SAW

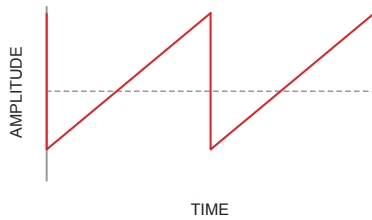

Square

SQUA

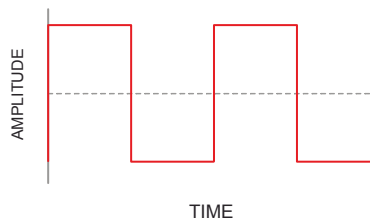

6.4 Sidechain Compressor

What is a Compressor?

A compressor is a device that reduces the peaks in an audio sound automatically as they exceed a specified threshold level. This reduces the dynamic range allowing the overall audio to then be increased using make up gain if desired. Deluge compressor is not a traditional audio compressor and focuses more on being a ducking envelope.

Standard compression signal is attenuated when crossing the threshold.

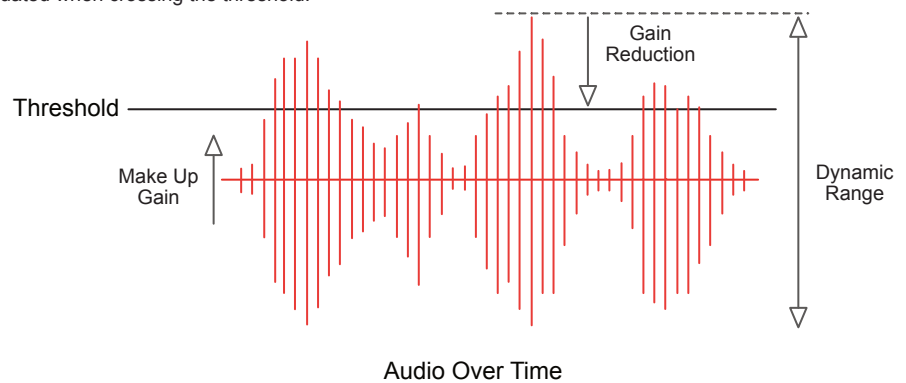

What is a Sidechain Compressor?

The principles of the sidechain compressor are identical to a standard compressor. The exception being that rather than the compressor trigger being a measure against its own input signal, an external source called a sidechain is the trigger of when to 'duck' i.e. reduce, the gain. Deluge, for example can use a kick drum to trigger a simultaneous gain reduction (duck) of a separate function.

Compression triggered by an external source to reduce gain at trigger points and levels.

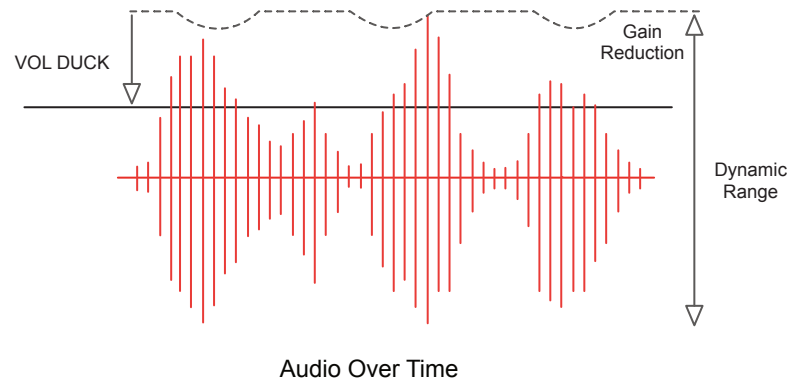

6 Modulation

Sidechain Envelope

The Deluge's sidechain compressor effect mimics the behaviour of a sidechain compressor fed short impulses such as a kick drum. Its output, and resulting volume-ducking behaviour, is governed by AR (attack + release) envelope.

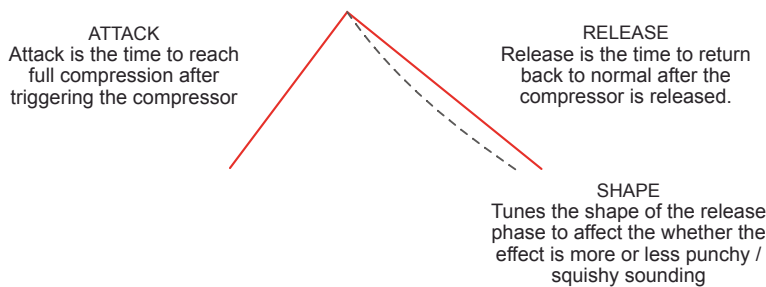

The attack and release times are important and have a key effect on the resulting feel of the sidechain compression effect.

Deluge Sidechain Example

Sidechain can be patched as a modulation source to various parameters. The amount of sidechain compression is set up through the modulation connection.

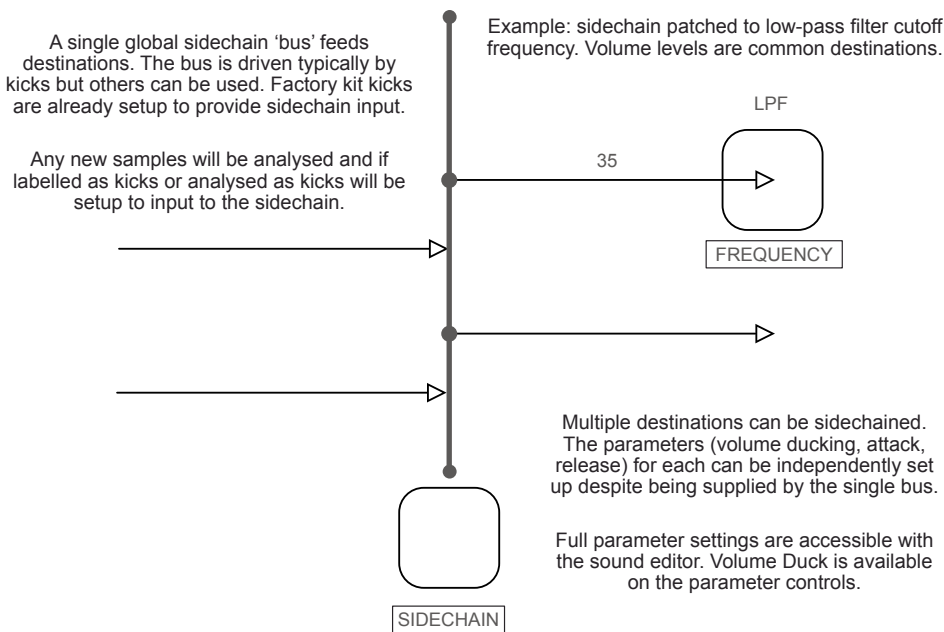

SETTING UP THE SIDECHAIN

1. Press [CLIP] to select clip view. This is indicated by the clip button illuminated blue.
2. Select synth by pressing [SYNTH] if not already selected. The synth button illuminates red.
3. Using the shortcut options to access the sidechain parameters directly e.g. press [SHIFT] + [VOL DUCK]. Alternatively use nested menus by pressing (SELECT) and then turning (SELECT) to navigate to the SIDEchain menu.

Options via the menu or directly from the [SHIFT] + Shortcuts are:

- VOL DUCK (VOLUME) : Amount which the sidechain affects the current sound. Can also be patched to other destinations.
 - SYNC : Sets the time interval of the sync for the compressor attack and release or OFF.. Options are 4 bar, 2 bar, 1 bar, 2nd notes, 4th notes, 8th notes, 16th notes, 32nd notes and 64th notes.
 - ATTACK : Sets attack transient time of the compressor kicking-in.
 - RELEASE : Sets the release time of the compressor.
 - SHAPE : Sets release phase of the compressor to make it more punchy or softer.
 - SEND : Used with kit sounds only. Level at which the trigger affects all other sounds sidechain compressors.
4. Use [BACK / UNDO] to exit sub menu and back up a level and out of the sound editor.

SELECTING SIDECHAIN SPEED

1. Press [SIDECHAIN / REVERB] affect button. Button illuminates orange.
2. Press (UPPER) to toggle between 'FAST' - fast synced to 32nd notes or slow - slow synced to 8th notes.

6 Modulation

6.5 Other Modulation Sources

NOTES

There are several other modulation sources that can be configured. Several such as aftertouch and velocity are dependant upon the external device connected and can be set up with MIDI in/out configurations. Note, sidechain and random are internally generated.

Random

Generates a random number with each new voice that is created. Can be used to provide randomness or movement when connecting to destinations so that every time a note is played a new random number drives the modulation destination.

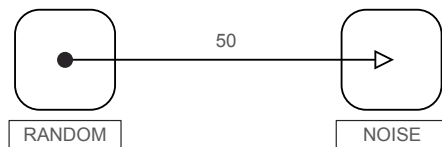

Example: Each key press generates a higher or lower noise element to the sound

Note

The note modulation being played is the source for this modulation option. Sometimes called *key tracking*, the pitch of the note is relevant to the modulation level generated.

6.6 Custom Parameter Affect Controls

There are three parameter functions contained in the affect parameter group. When using presets these will be set to a specific parameter within the preset. The Deluge convention is:-

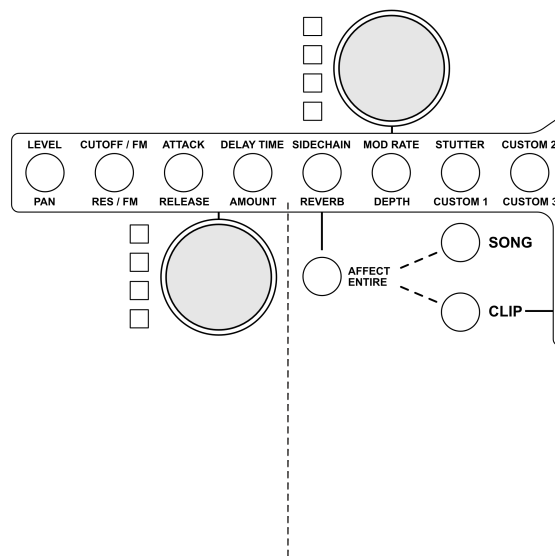

Custom 1

Typically controls pitch for sample based sounds.

Portamento for synth sounds.

Custom 2

Typically controls decimation for kits and sample-based sounds.

Custom 3

Typically controls bitcrushing for kits and sample-based sounds.

Other Parameter Controls

While the custom controls are specifically designed to be assigned to user parameters, the other parameter affect controls can also be assigned to additional user parameters if required.

[LEARN / INPUT] + Turn (CONTROL)

○ BACK / UNDO
 REDO

○ LOAD
 NEW

○ SAVE
 DELETE

● LEARN / INPUT

6 Modulation

■ ASSIGNING CUSTOM CONTROL PARAMETERS

1. Press [CUSTOM X] where x is one of the custom buttons 1, 2 or 3. Custom 1 & 3 are under the lower rotary control and custom 2 upper control.
2. Access the sound editor by pressing (SELECT). Navigate to a parameter to assign. Example : pan
3. When the desired parameter is in-focus, press & hold [LEARN / INPUT] + turn (UPPER) or (LOWER) - the rotary which is assigned to the custom control in step 1.
4. The display will flash 'LEARN' to indicate parameter assignment. Parameter is assigned for the specific function.
5. Unassignment is performed by reassigning the parameter control.

■ ASSIGNING USER PARAMETERS TO EXISTING CONTROLS

1. Press the desired parameter control button to change, for example [LEVEL / PAN].
2. Access the sound editor by pressing (SELECT). Navigate to a parameter to assign. Example : Osc > Volume.
3. When the desired parameter is in-focus, press & hold [LEARN / INPUT] + turn (UPPER) or (LOWER) - the rotary assigned to selection in step 1
4. The display will flash 'LEARN' to indicate parameter assignment. Parameter is assigned for the specific function.
5. Unassignment is performed by reassigning the parameter control.

MIDI controller controls are also assigned using the same process. MIDI Controls can also be unassigned by navigating to the parameter and by then press and hold [SHIFT] + [LEARN/INPUT].

ASSIGNING CONTROLS TO MODULATION DEPTH

1. Press the desired parameter control button to change, for example [CUSTOM 1].
2. Access the modulation connection patching by pressing [SHIFT] + *Modulation Destination*. Press (SELECT) to drill down to the modulation depth parameter.
3. When the desired parameter is in focus, press & hold [LEARN / INPUT] + turn (UPPER) or (LOWER) - the rotary which is assigned to the parameter selected in step 1.
4. The display will flash 'LEARN' to indicate parameter assignment. Parameter is assigned for the specific function.
5. Unassignment is performed by reassigning the parameter control.

Example: sidechain patched to low-pass filter cutoff frequency with a custom control assigned to adjust the depth / strength of modulation.

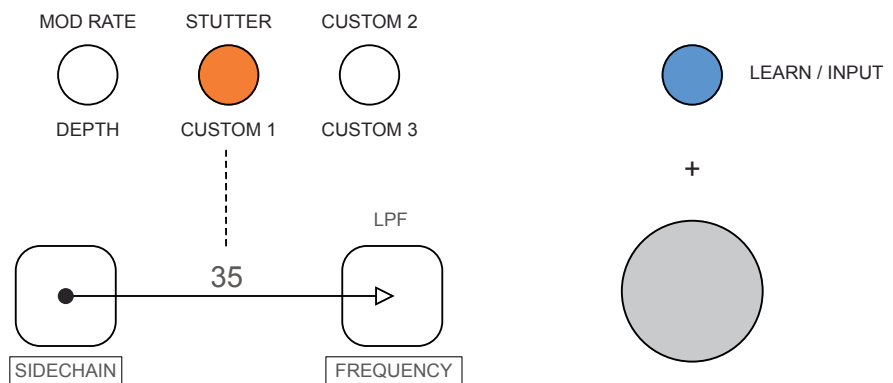

Select parameter i.e. CUSTOM 1. Set modulation value in focus. press & hold [LEARN / INPUT] + turn (LOWER) parameter control.

SONG VIEW

7 Song View

7.1 Song Workflow

NOTES

An example high level workflow for working with SONGS on Deluge

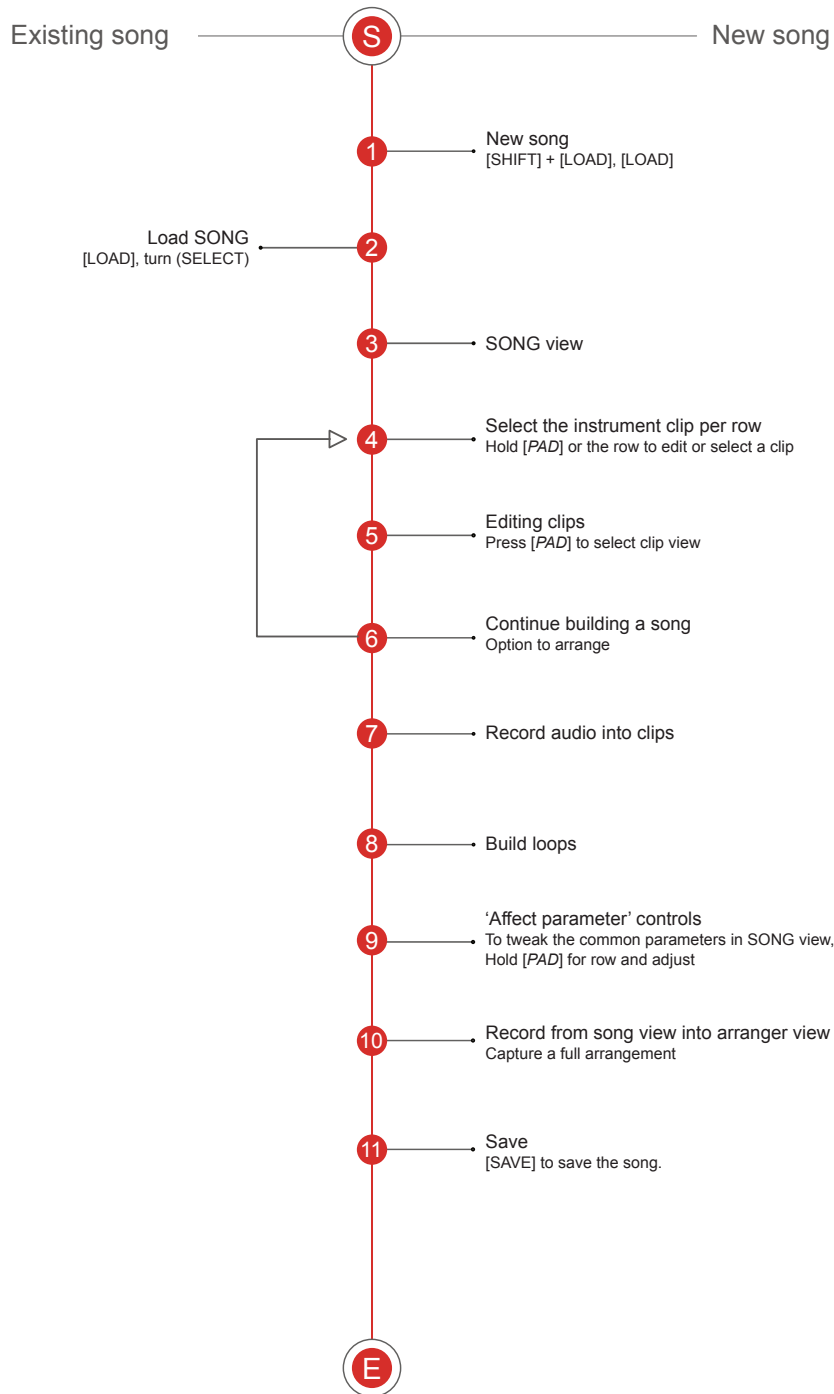

7.2 Song View Basics

While the synth and kit clip view is used for developing individual instrument sequences, song view provides a more holistic approach, consolidating all clips into a compressed view, each clip shown as a row. Song view is where all existing clips are managed together, new clips can be added, existing ones deleted and reordered. Controls to launch and stop clips is provided in song view. Song view is also the main area to handle loop recording and playback, covered elsewhere in this guide.

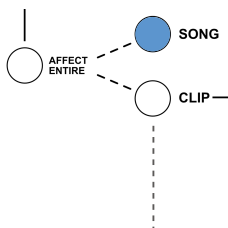

Song view compresses all clips and takes an overall view of the song 'project'.

First time entering song view only one clip will be present. Clips can be created, re-ordered, deleted in song view.

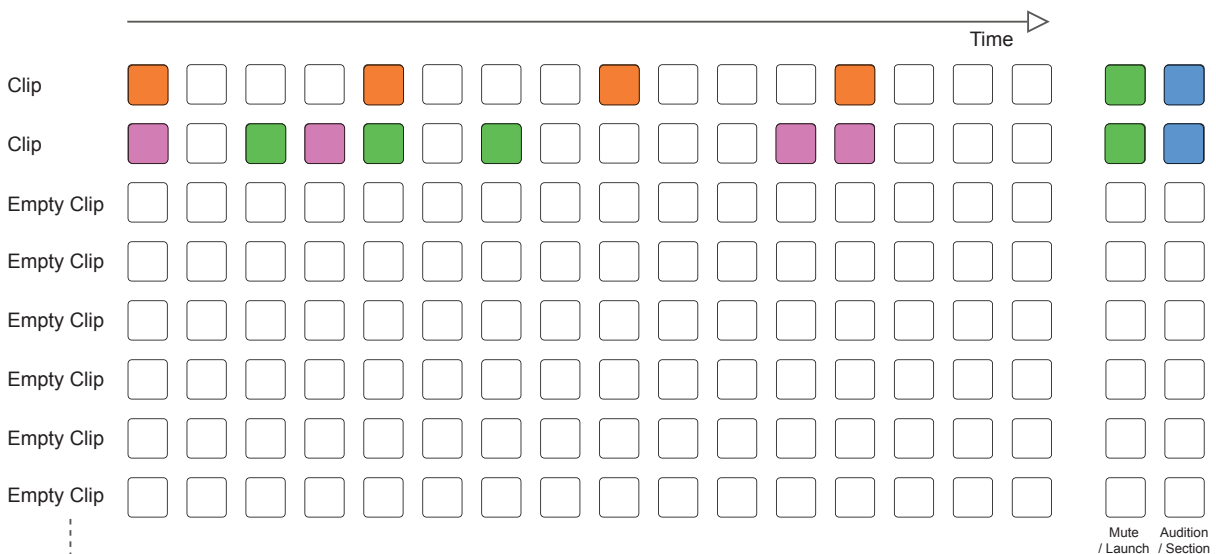

(SCROLL ▼▲)
Individual clips compressed to one row each in song view. The rows can be navigated up and down beyond the 8 physically displayed.

[LAUNCH]
The mute / launch column pads now takes on the 'launch' functionality when in song view. Rows containing clips are illuminated. Pressing the corresponding LAUNCH pad will trigger the clip for that row. When the sequence is playing launch will firstly arm the clip, then launch it, played in time with the sequence. Use [SHIFT] + [LAUNCH] for instant play.

[SECTION]
The audition / section column pads now takes on the 'section' functionality when in song view. Rows containing clips are illuminated. Sections enable groups of clips to be launched and controlled simultaneously. Clips can be armed, stopped, played together as a group.

Deluge will only play one instrument at one time in song view. So for example, if two clips use the same synth preset 1, the clip rows can each be launched but each one will stop playback of the other, allowing only one instance of each instrument to play at one time.

7 Song View

PLAYING A SONG

1. Press [SONG] to switch to song view. The button illuminates blue. If this is a new song and the first this time the song mode is selected, the song may be empty or only show the first clip compressed to the first row.
2. Press [PLAY]. Song will playback and the white song position cursor will travel left to right.
3. Rows occupied by clips are lit and the [LAUNCH] pads will be green while the [SECTION] pads are lit blue.
4. Press [PLAY] to stop and reset playback position to the song start.

CREATING A NEW CLIP FROM SONG VIEW

1. Press [SONG] to switch to song view. The button illuminates blue.
2. Press a [PAD] of any empty, unlit row from the 16 x 8 main grid.
3. Deluge creates a new clip and transfers the view from song to clip view with synth selected by default.
4. Any edits, change to synth / kit, steps created etc in the clip will be reflected when switching back to [SONG] view with the clip added as a compressed single row.

SELECTING AN EXISTING CLIP TO EDIT FROM SONG VIEW

1. Press [SONG] to switch to song view. The button illuminates blue.
2. Press a [PAD] of any occupied row from the 16 x 8 main grid. The occupied rows containing clips will be illuminated fully or in part.
3. Deluge transfers the view from song to clip view with clip selected ready to edit.
4. Any edits, steps created etc in the clip will be reflected when switching back to [SONG] view.

Where there are multiple instances of the same instrument preset they will not play simultaneously. Only one will play when launched and the others with the same instrument will be stopped.

7.3 Advanced Control of Single Clips in Song View

More advanced options are available in song view than just the start stop commands for individual clips. Clips are armed to ensure the timing of the clip start aligns with the overall song. The LAUNCH pad column (used for MUTE in clip view) is the important control function used in song view.

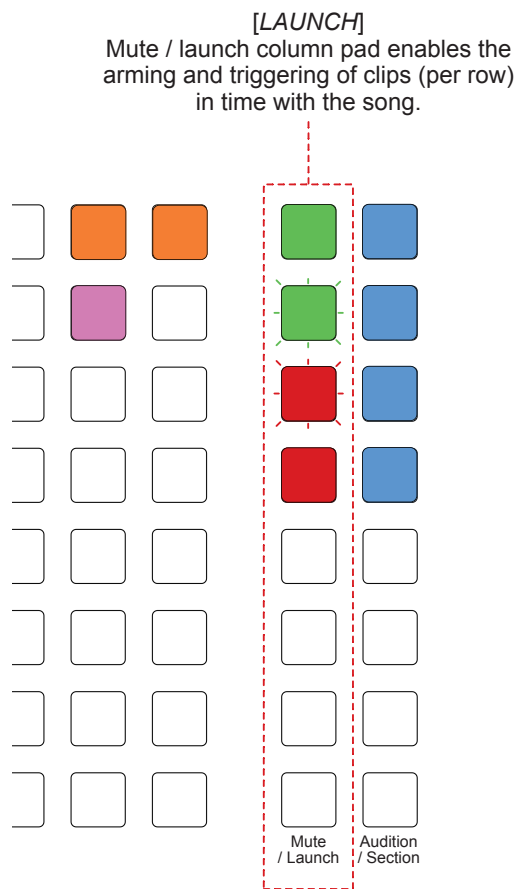

Press [LAUNCH] pad to play the clip row in song view.

Launch status

GREEN

Clip is 'launched' : when playing or stopped.

RED

Clip is 'stopped' : when playing or stopped.

GREEN FLASHING

Clip is 'armed' ready to stop at its seq end: when playing.

RED FLASHING

Clip is 'armed' ready to play in time: when playing.

Display shows countdown of loops to complete when a clip row is 'armed' and launching or stopping clips, default is 1. To increase the loops to play prior to launch / stop, turn (SELECT) to change the loop countdown. Press (SELECT) to cancel loop countdown.

Press [SHIFT] + [LAUNCH] pad to immediately play the clip row in song view.

7 Song View

IMMEDIATELY LAUNCHING / STOPPING A CLIP IN SONG VIEW

1. With the sequencer playing, Press [SHIFT] + [LAUNCH] pad, where LAUNCH is the row of the clip to play.
2. If the clip was not playing, it will immediately play in time with the sequence.
3. If the clip was already playing it will immediately stop.

ARMING TO LAUNCH / STOP A CLIP IN SONG VIEW

1. With the sequencer playing, Press [LAUNCH] pad, where LAUNCH is the row of the clip to play.
2. If the clip was not playing, its launch pad will flash red until the clip is aligned to the sequence loop (indicated by the display countdown number). At sequence alignment point it will play and the pad will be illuminated solid green.
3. If the clip was already playing its pad will flash green until the sequence reaches its end. The pad will then be illuminated solid red and the clip is then stopped. The display will show the countdown number for the sequence.

ADJUSTING ARMED COUNTDOWN ON THE FLY

1. When a clip is armed to launch or to stop it will flash red or green respectively. During this time the display will show a countdown number that signifies a full or part loop to complete prior to launch / stop.
2. While the number is displayed, turn (SELECT) to adjust the number of the loop countdown - increasing or reducing the wait timer to trigger the launch / stop command.
3. While the number is displayed, press (SELECT) to clear the countdown timer and clear arming of the clip.

NOTES

SOLOING CLIPS IN SONG VIEW

1. To solo a clip, press & hold (SCROLL ◀▶) + press [LAUNCH] pad of clip row to solo.
2. If the sequence is playing the solo request will be 'armed' to solo on the next repeat cycle. Pad will flash when armed.
3. The launch pad will illuminate blue when the clip row is played in solo.
4. Other clips of course will be muted and these will be dimly lit.
5. To remove the solo, press the [LAUNCH] pad.
6. To solo immediately without arming, press & hold [SHIFT] + (SCROLL ◀▶) + press [LAUNCH] pad.

7 Song View

7.4 Editing Clips in Song View

NOTES

Song view also provides the functionality to edit certain features of clips from within this view. Changing instruments, cloning and deleting clips is possible.

■ CHECKING THE INSTRUMENT FOR A CLIP

1. Press [SONG] to switch to song view.
2. Press & hold a [PAD] within the clip row to check.
3. While still holding, the instrument button will flash indicating the type selected and the display will show the instrument preset. For example synth, preset 1
4. Affect parameters for the clip also become available and in-focus.
5. Holding a clip in an empty clip row will show the instrument type and preset that it will create when tapping the clip row.

[PAD]
Press & hold pad for clip row to
show the instrument and preset
for the clip

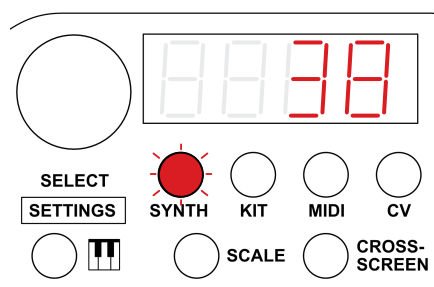

■ CHANGING THE CLIPS INSTRUMENT FROM SONG VIEW

1. Press [SONG] to switch to song view.
2. Press & hold a [PAD] within the clip row to change.
3. While still holding, select the instrument type, example [SYNTH], [KIT].
4. While still holding, select the instrument preset by turning (SELECT).
5. Holding a clip in an empty clip row will also allow changes to be made.

■ CREATING AN AUDIO CLIP IN SONG VIEW

1. Press [SONG] to switch to song view.
2. Press & hold a [PAD] within the clip row. This can be either an existing or blank row. The instrument button will flash indicating the type selected and display will show the preset or MIDI/CV Channel.
3. While still holding the pad, press (SELECT).
4. The track will be converted to an audio clip and the display will show the name, example: 'AUDIO1'. If notes exist 'CANT' is displayed and the clip wont be converted.
5. Selecting the audio clip will allow audio to be loaded, recorded, edited.

■ DELETING A CLIP FROM WITHIN SONG VIEW

1. Press [SONG] to switch to song view.
2. Press & hold a [PAD] of the clip row to delete + press [SAVE / DELETE].
3. The clip will be deleted and the row above moved down. Undo / redo functions are not available.

■ MOVING A CLIP ROW FROM WITHIN SONG VIEW

1. Press [SONG] to switch to song view.
2. Press & hold a [PAD] within the clip row to move + turn (SCROLL ▼ ▲).
3. The clip will be relocated into a different row relative to the other clips.

■ CLONING A CLIP FROM WITHIN SONG VIEW

1. Press [SONG] to switch to song view.
2. Press & hold a [PAD] within the target clip row to clone + press a [PAD] on the destination row where the new cloned clip will be located.
3. The clip will be cloned from the target to the destination and assigned a different section and won't be launched. Cloned clips are initially linked to the original but can be edited.

7 Song View

■ UNLINKING CLONED CLIPS WHEN USING SAME PRESET

Clips with the same preset cannot be used multiple times within multiple instruments in the same song. If a preset is already in use, the preset can be unlinked from its “original” creating an independent version. Example, to reuse preset 10, a new unlinked version, can be created as 10A. This allows multiple clips with the same preset.

1. [LOAD] + [SYNTH] or [LOAD] + [KIT] to open a preset using the preset load menu as opposed to selecting a present by turning (SELECT).
2. The alphanumeric keyboard will open to search a preset by name if required.
3. Turn (SELECT) to choose the same preset that is already used. Example preset 10.
4. Press [LOAD] will show 'USEd' - used, indicating this is a preset already in use in the song.
5. Press & hold [LOAD] until 'Clon' - clone displays.
6. Press [LOAD] again, and a new independent version will be loaded. Example 10A.

■ EDITING CLIP PARAMETERS IN SONG VIEW

1. Press [SONG] to switch to song view.
2. Press & hold a [PAD] within the clip row of which to change the parameters.
3. While still holding, the affect parameter functions will be accessible.
4. The 8 parameter buttons can be changes and the associated (UPPER) and (LOWER) controls adjusted while ever the [PAD] is held in song view.

7.5 Song Sections

Song sections group together clips so that they can be controlled, launched, armed etc together making it easy to play arrangements and structure live sets. Sections can be structured into a chained sequence automatically playing each. Sections are colour coded for clarity and controlled by the [SECTION] pad column in song view.

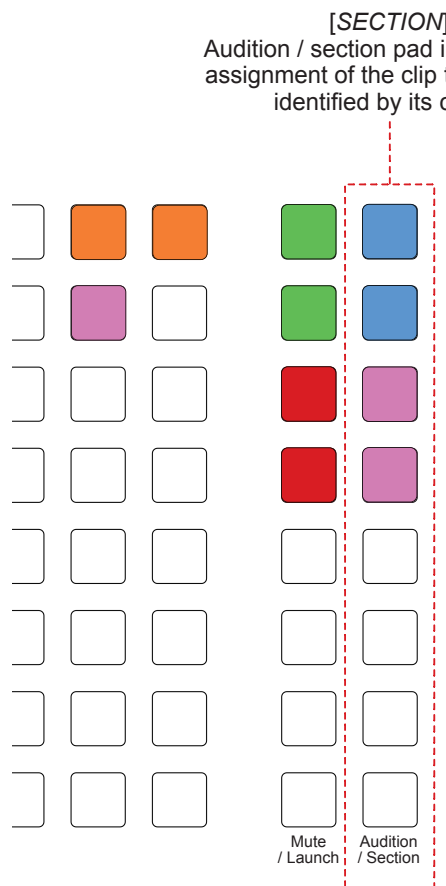

Press [LAUNCH] pad to play the clip row in song view.

Clips belong to the same section that is indicated by that specific pad colour. Colours show the section groupings.

CHANGE SECTION

Press [SHIFT] + [SECTION] pad to toggle a colour coded section.

MANUALLY ARM SECTION

Press [SECTION] pad of the desired section to manually arm the section.

REPEAT MODE

Press & hold [SECTION] pad + (SELECT) to change repeat mode Infinite - 'inFi' (default), number, share.

Display shows countdown of section repeats when a repeat number is defined. To increase the sections to play prior to launch / stop, turn (SELECT) to change the section countdown. Press (SELECT) to cancel section countdown.

7 Song View

SELECTING A SECTION FOR A CLIP

1. Press [SONG] to switch to song view.
2. Press [SHIFT] + [SECTION] pad for the clip row of which to change the section.
3. The section colour will be changed. Toggle the selection until the section group desired is selected. This is defined by SECTION pad colour.

ARMING TO LAUNCH / STOP A SECTION IN SONG VIEW

1. With the sequencer playing, Press a [SECTION] pad of the section to launch. The section group of clip rows will all be the same colour.
2. The LAUNCH pads will flash when a repeat countdown is armed and any count shown on the display. The launch pads show the clip play status of green when in play and red when stopped.
3. The section will play when launched for the number of cycles set by 'REPEAT MODE' for the section.

SETTING REPEAT MODE FOR A SECTION IN SONG VIEW

1. Press & hold [SECTION] pad of the section to change.
2. The repeat mode status will flash on the display. While holding the section pad, turn (SELECT).
 - 'inFi' - infinite. This will play the section infinitum or until a manual change is made.
 - '1' - number will set the amount of repeats that the section will play prior to moving to the next section. This will be displayed as a countdown and can be changed by turning (SELECT) or cancelled by pressing (SELECT).
 - 'SHAR' - share. This enables the sharing launch status with other sections. Note that clips sharing a preset do not play simultaneously in song view.
3. The section will play when launched as set by 'REPEAT MODE' for the section.

7.6 Saving & Loading Songs

Songs can be saved and loaded to/from the inserted SD card. Songs are numbered 0-999 or can be named using the alphanumeric grid keyboard. Variations of each saved slot also has sub slots, for example if slot 5 is saved, 5A, 5b, SONGNAME 1, SONGNAME 2 etc will be incrementally offered.

SAVING A NUMBERED SONG

1. Ensure view is in [SONG], [CLIP], [ARRANGER] or [KEYBOARD].
2. Press [SAVE].
3. The available song slot to save to will be displayed flashing. Slots between 0-999 are available and when saving to an existing save slot, the next sub slot is presented. Slots where saves exist are shown with a period / full stop after the digit, example 5A.
4. Turn (SELECT) to select another slot number if required.
5. Press [SAVE] again to save the Song or [BACK / UNDO] to back up and exit.
6. Song will save and return to the previous view.

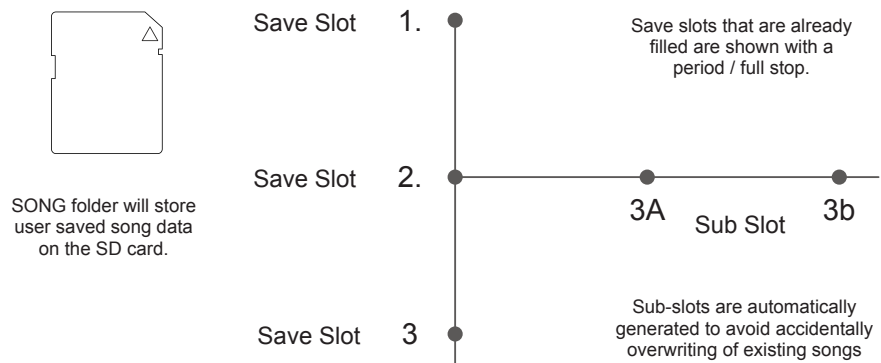

SONG folder will store user saved song data on the SD card.

Saving and loading can be performed while playing. The transition is managed without interruption to playback, switching between at the loop end.

7 Song View

SAVING A NAMED SONG

1. Ensure view is in [SONG], [CLIP], [ARRANGER] or [KEYBOARD].
2. Press [SAVE].
3. Songs can be named using the alphanumeric grid keyboard. Subsequent iterations of the song will be automatically created when existing saves exist. Example SONGNAME will also have SONGNAME 1, SONGNAME 2 etc when iterations are saved.
4. Deleting the name manually using backspace will revert back to the numbering system.
5. Turn (SELECT) to select the slot / name.
6. Press [SAVE] again to save the song or [BACK / UNDO] to back up and exit.
7. Song will save and return to the previous view.

LOADING A SONG

1. Ensure view is in [SONG], [CLIP], [ARRANGER] or [KEYBOARD].
2. Press [LOAD].
3. The available songs slot to load to will be displayed flashing. Named files and numbered slots between 0-999 are available as well as sub-slots, example 5A.
4. Turn (SELECT) to select the song required. Hold [SHIFT] & turn (SELECT) to skip sub-slots when navigating, - this is only for numbered songs, not named song sub-slots.
5. . The alphanumeric keyboard can be used for selecting named samples.
6. The songs, while navigating the songs, will be previewed visually on the 16x8 grid.
7. Press [LOAD] again to load the song in focus or [BACK / UNDO] to back up and exit.
8. Song will load.

NOTES

DELETING A SONG

1. Ensure view is in [SONG], [CLIP], [ARRANGER] or [KEYBOARD].
2. Press [LOAD].
3. The available songs will be displayed flashing. Slots between 0-999 are available as well as sub-slots, example 5A.
4. Turn (SELECT) to select the song required. Hold [SHIFT] & turn (SELECT) to skip sub-slots when navigating. The alphanumeric keyboard can be used for selecting named samples.
5. Press [SHIFT] + [SAVE] to select song delete mode, indicated by 'DELE' flashing on the display.
6. Press [SAVE] again to delete the song in focus or [BACK / UNDO] to back up and exit.
7. Song will be deleted.

CREATING A NEW BLANK SONG

1. Ensure view is in [SONG], [CLIP], [ARRANGER] or [KEYBOARD].
2. Press [SHIFT] + [LOAD].
3. Display will blink 'NEW' indicating a new blank song is about to be created.
4. Press [LOAD] again and a new blank song is created, clearing previous data. This is the same as the default empty song at start up.

7 Song View

LOADING A SONG DURING PLAYBACK

1. Ensure view is in [SONG], [CLIP], [ARRANGER] or [KEYBOARD].
2. Press [PLAY] or make sure the song is playing.
3. Press [LOAD] .
4. Turn (SELECT) to select the song required. Hold [SHIFT] & turn (SELECT) to skip sub-slots when navigating. The alphanumeric keyboard can be used for selecting named samples.
5. Press [LOAD] to load the song in-focus. Song will load 'armed' ready for completion of the existing song playback at which point it will launch. Songs with large sample content may take some time to load.

or

6. Press & hold [LOAD] to load and delay arming until fully loaded. DONE will be displayed when loading is complete. Releasing the [LOAD] button will 'arm' the song ready for completion of the existing song loop.
7. Arming songs is applied the same way as clips. The countdown can be adjusted using (SELECT).

LOADING A SONG AND RETAINING EXISTING SONG TEMPO

1. Ensure view is in [SONG], [CLIP], [ARRANGER] or [KEYBOARD].
2. Press [PLAY] or make sure the song is playing.
3. Press [LOAD] .
4. Turn (SELECT) to select the song required.
5. Press & hold (TEMPO) + [LOAD] to load the song in-focus at the current tempo.
6. Depending on the tempo mode will govern how the tempo is managed:-
 - Tempo magnitude matching enabled: will apply a multiple of the old song tempo if needed to avoid drastic changes to a new tempo.
 - Synced as a follower: tempo will remain the same irrespective of tempo magnitude matching.

7.7 Collect Media Function

To enable portability of songs across SD cards, backup and sharing for collaboration with other Deluge users, a tool exists to collect together all content and sample files which a song file uses.

COLLECTING MEDIA

1. Press [SAVE].
2. The save window will open and the alphanumeric keyboard appears to enter a name for the song.
3. Prior to entry of a number or name, press & hold [SAVE] again until 'CoLL' - collect menu opens and appears on the screen.
4. Press [SAVE] yet again.
5. Song is saved;-
 - A new folder is created with the same name as your song file.
 - The folder will be located within the SONGS folder on your SD card.
 - The folder will contain copies of all the song's samples.
 - 'donE' - done will confirm saving.

To transfer the song to another SD card or another user, both the song file (e.g. "SONG100.XML") and the song folder (e.g. "SONG100") need to be placed in the SONGS folder on the destination card. The song can now be loaded from that card with all its samples.

When a song imported in such a way is re-saved, its samples are all copied into that card's normal SAMPLES folder - into the same subfolder locations that they had originally been referenced from.

When collecting media in this way, the Deluge automatically adds a string of random characters onto the ends of Deluge-recorded samples, so there won't be confusion / overwriting between Deluge users who all have a different e.g. "REC00001.wav" file present.

— ARRANGER VIEW —

8 Arranger View

8.1 Typical Arranger Workflow

NOTES

Establishing a good workflow is where speed and productivity can help make way for more creativity especially at the arrangement stage.

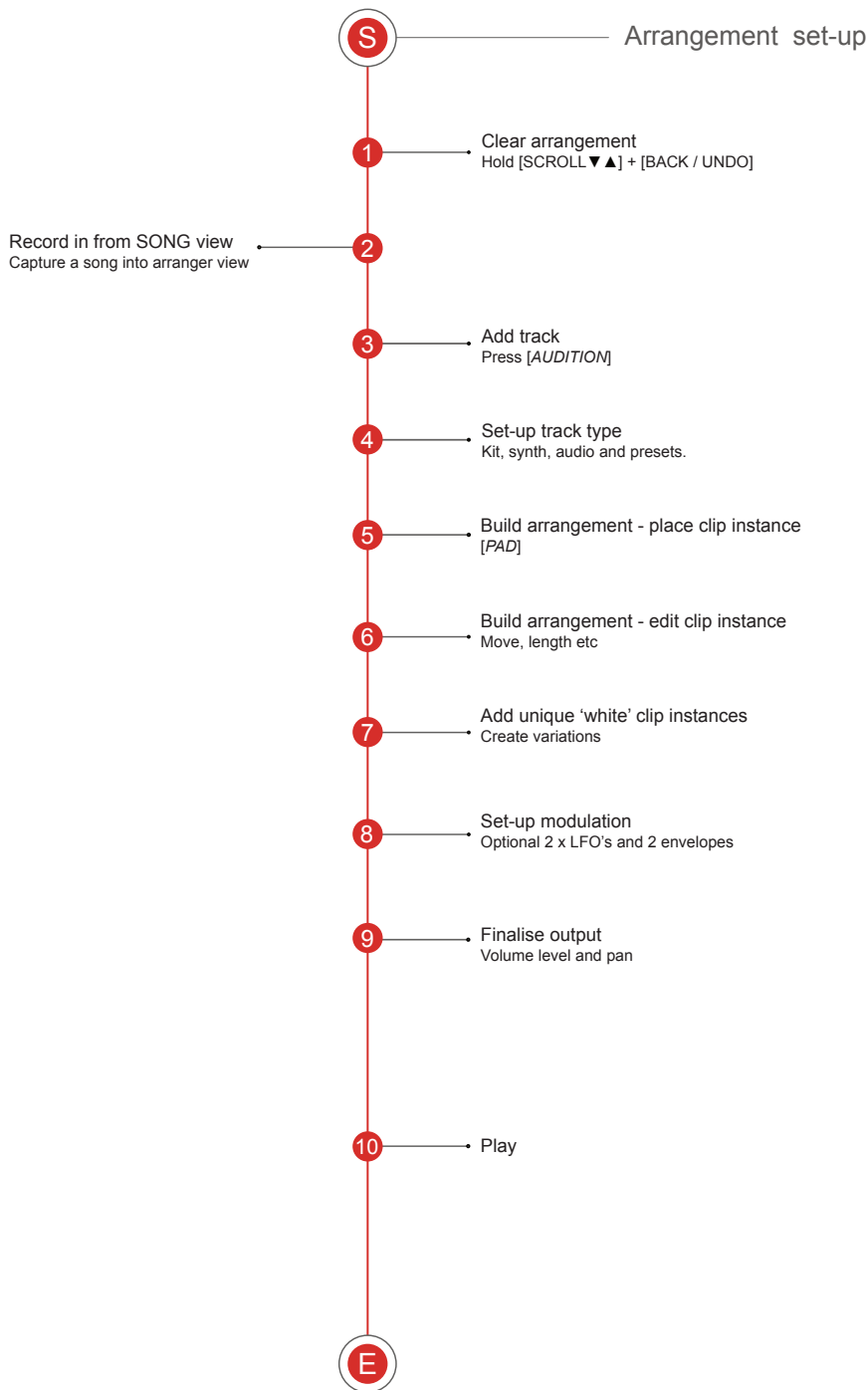

8.2 Arranger relationship with the other views

Arranger consists of a group of linearly arranged instrument and audio clip instances of which reference the section colours from those in song view. Think of arranger view as an extension of song view rather than a stand-alone function. Understanding the relationship with clip, song and arranger is important.

Relationship Between Views

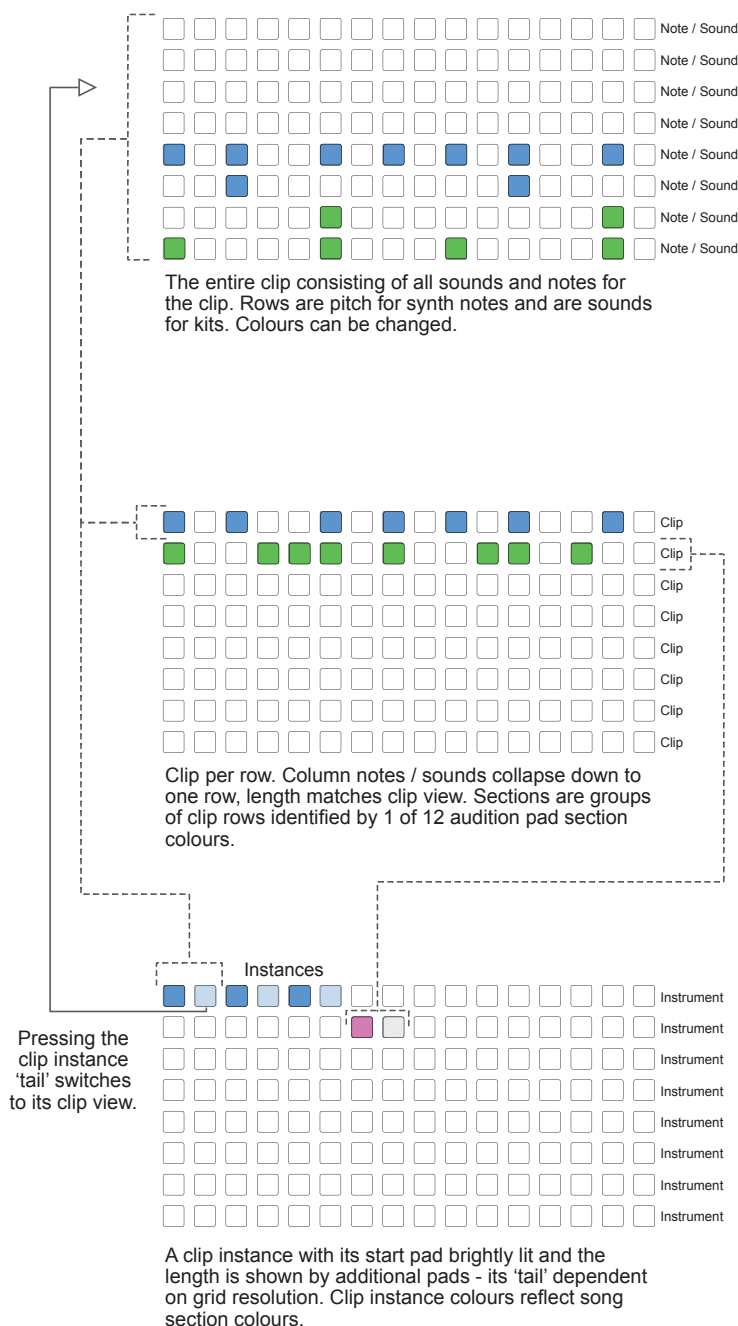

Clip View - [CLIP]

Rows: discrete synth note pitch or kit sounds.

Mute / launch: mute's sounds or notes.

Audition / section: auditions notes / sounds.

Clip is the entire grid. 5 types of clips exist; synth, kit, MIDI, CV and audio. A clip contains sequencing or audio for each discrete clip element.

Song View - [SONG]

Rows: single instrument or audio clip compressed to a representative 1 row each.

Mute / launch: launches clips. Used for looping control and commands.

Audition / section: sections & section launch by colour. Used for looping control and commands.

Clips are arranged into single rows where they can be triggered individually or together in groups managed as coloured sections.

Arranger View - [SONG] [SONG]

Rows: individual instrument, MIDI, CV, audio per row.

Mute / launch: mutes / unmutes the 'track' row.

Audition / section: auditions a clip by one of its sounds.

Clip instances, arranged in a linear sequencer, handled on an instrument by instrument basis, covers audio clips and includes variations, gaps and parts to be assembled together.

8 Arranger View

8.3 Arranger View Basics

Arranger view allows the chaining of clip instances into a longer more linear arrangements. Song view operates from the perspective of a collection of clips with each clip represented by a row. Arranger view takes its perspective based on 'tracks'. Each track is presented on a row and represents an individual Instrument, MIDI, CV or audio element. The pads therefore represent clip instances.

Arranger View

Clip Instance
Clip instances are placed in arranger view by pressing a pad on the instrument row. By default each pad will represent an instance of say 8 x 1/16th steps. This is dependant on the grid resolution and can be zoomed and length changed.

Clip Length
The first (left most pad) will be lit bright. The additional dimmer pads will indicate length or 'tail' of the clip. Pressing a dimmed pad will switch to its clip view. Setting length beyond clip length will loop the clip instance and shortening it will truncate the clip.

Time

Clip instances are sequenced per track, laid out in linear fashion at defined intervals and lengths. Tracks represent each instrument / MIDI / CV per row. A white column 'cursor' will signify the play position

Track Rows
Represent a specific instrument, MIDI or CV. The tracks and clip instances are represented by colours as per the sections set up in song view. The rows will by default be populated in synth preset order.

White clips in arranger view signify unique independent clip instances.

Audition / Section

SONG VIEW

[MUTE]
The mute / launch column pads takes on the 'mute' functionality when in arranger view. Rows containing clip instances are illuminated. Pressing the mute pad for the track / row will mute it and be lit yellow, unmuted tracks lit green. Solo can be selected for the track by pressing (SCROLL ◀▶) + [MUTE] where it will be lit blue and others dimmed.

[AUDITION]
The audition / section column pads play-out the tracks synth root note or a kit sound. Audio tracks will not play. To load a new preset to the instrument, Press [AUDITION] + turn (SELECT). Press [AUDITION] + instrument or type to change it i.e. kit or synth.

NOTES WHEN WORKING IN ARRANGER VIEW

- Clip, song and arranger views are not independent functions. They offer different personas and views and are specific tools when working on the same project and its common data (notes, kits etc).
- Clip 'instances' are identical, linked copies of the original clip. Changing the instrument notes, structure of the actual clip will change equally in all instances.
- Each row represents a track. Only one row per instrument, MIDI, CV, audio and therefore each instance resides on the same row.
- Clips including the length and song sections should be set up first. These form a prerequisite to arranging the clips in arranger view.
- Colours of clips in arranger view reflects the colours for the respective section in song view.
- White clips in arranger view indicate unique clip instances which are independent, detached from any original source clip. Used for variations and fills.

SELECTING ARRANGER VIEW

1. Select [SONG] view.
2. From within song view, press [SONG] again to switch to ARRANGER view. The song button will flash blue.
3. Press [SONG] again to return back to song view - button lit blue.

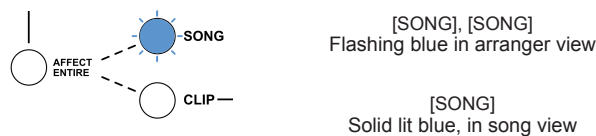

Arranger view can only be selected from within song view. Clip view cannot be directly selected from arranger view using [CLIP] and needs to be in song view first to then enable a switch to clip view. Alternatively pressing any clip instance [PAD] other than the first, left most pad will switch the clip to its clip view.

8 Arranger View

■ BASIC CLIP INSTANCE PLACEMENT IN THE ARRANGER

1. Ensure a collection of clips have been produced in clip view, lengths set and arranged as desired and with sections in song view as desired.
2. Select [SONG] for arranger view. Button flashes blue.
3. Arranger view is entered.
 - The grid will be initially blank.
 - The mute / launch pads will be lit. For example, if 3 instruments are used in song view, maybe each with several clips each, then 3 rows will be set for the three instruments.
 - The audition / section pad can be played to listen to a selected sound, ie: snare from a kit or the root note from the synth preset for the specific instrument. Holding down on audition pad will reveal the name of that preset in the display.
 - Rows will default to presets when the audition pad is played for an instrument not used with a clip.
4. Press a [PAD] for the location at the start of the clip instance and on the row for the desired instrument.
 - The pad will illuminate to match the song section colour.
 - The length will be set based on the original clip length and displayed based on the arranger grid resolution.
 - The length will be indicated by the pads following the first solid lit pad - the additional pads or the 'tail' will be dimly lit.
5. Press a 'tail' pad to switch back to its clip view. Pressing [SONG] in clip view having switched from the arranger, returns the view back to arranger.
6. Repeat to add more clip instances. Clips placed on the grid will default to the same section colour as the last clip instance placed.

NOTES

CHANGING THE CLIP INSTANCE ON THE SAME INSTRUMENT

1. Press & hold [PAD], the clip instance to change + turn (SELECT).
2. The clip instance options available will be selected with the select control. The pad will change its colour based on its section colour in song view.
3. Changes will take place at every 'click' iteration of the *select* control knob.

PLAYING TRACKS IN ARRANGER

1. Press [PLAY] the tracks will play from the start.
2. Press & hold (SCROLL ◀▶) + [PLAY] to play from desired/current scroll position.
3. Press [PLAY] to stop playback.
4. A white column 'cursor' will step through the grid in time with the sequence. Any muted rows / instruments will be shown muted yellow on the cursor. Press CROSS-SCREEN EDIT to switch between the cursor remaining fixed and the arrangement moving from right to left, or the cursor scrolling through the arrangement.

INSERTING OR DELETING TIME SLOTS IN ARRANGER

1. Press [SHIFT] + turn (SCROLL ◀▶) will move all the clip instances currently visible on the grid left or right in time.
2. Moving the clips right - turn clockwise, will insert time space before the first clip, moving the existing clip instances later in time.
3. Moving the clips left - turn anti-clockwise, will remove any time available before the first clip, or delete clips as they 'drop off' the left side of the grid.

Undo / redo options are available within the arranger view. This may be particularly useful if clips are deleted when removing time from the arranger grid.

8 Arranger View

EXTENDING / REDUCING A CLIP INSTANCE LENGTH

1. Press & hold [PAD], the first, brightly lit pad + [PAD] on the same row.
2. Placing the second [PAD] longer than the original length will extend the clip instance, looping its content for the new duration.
3. Placing the second [PAD] shorter than the original length will mean the clip playback will truncate at the new end location.
4. The length will show a bright first pad and dimmer 'tail' pads for the clip instance length.

SETTING THE ARRANGER GRID RESOLUTION

1. Press (SCROLL ◀▶) when in arranger view to display the current grid resolution setting. Default is 2nd.
2. Press & turn (SCROLL ◀▶) to change the grid resolution for the clip instances.
3. Options available will determine how the clip is displayed on the grid with respect to the clip length. For a 16 x 16th steps / 1 bar:-

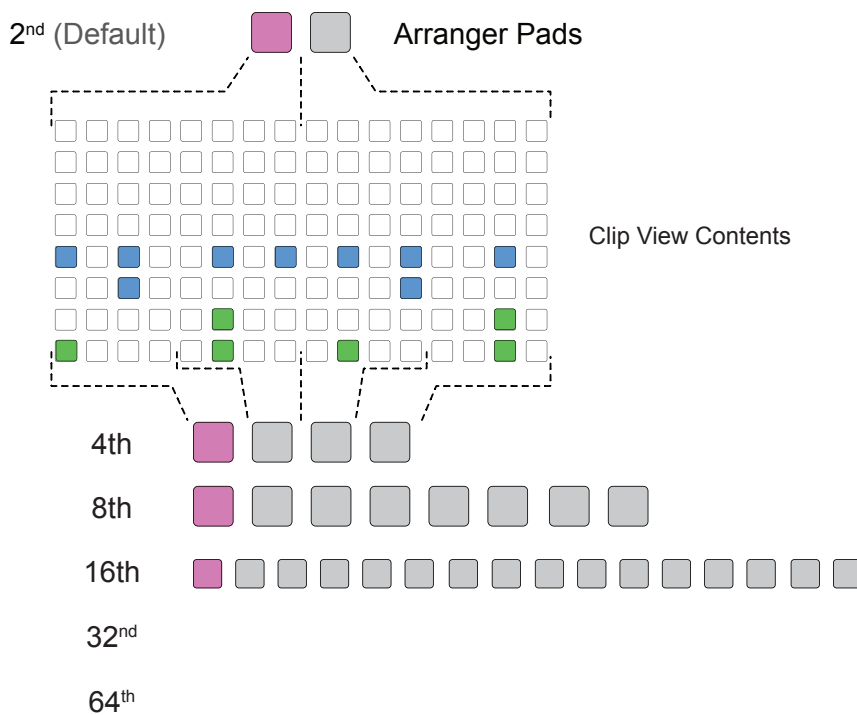

■ ADDING / CHANGING TRACK DIRECTLY IN ARRANGER

1. Press & hold [AUDITION] - unassigned audition pad + turn (SELECT) to select an available preset for the track row.
2. To change an existing preset:-
 - Press & hold [AUDITION] pad for the instrument / row to change + turn (SELECT) to scroll the presets.

or

 - Press & hold [AUDITION] pad for the instrument / row to change + track type [SYNTH], [KIT], [MIDI], [CV].

or

 - Press & hold [AUDITION] pad for the instrument / row to change + press (SELECT) for an audio track.

■ SOLOING TRACK IN ARRANGER

1. Press & hold (SCROLL ◀▶) + [MUTE] of the selected row to solo.
2. Mute button for the row illuminates blue. Other row tracks are dimmed.

■ REORDERING AN INSTRUMENT TRACK IN ARRANGER

1. Press & hold [AUDITION] pad of the selected row to move + turn (SCROLL ▼▲).

■ DELETING A TRACK IN ARRANGER

1. Press & hold [AUDITION] of the selected row to delete + [SAVE].
2. Instrument track will be deleted or display will show 'CANT' if the instrument cannot be deleted.

■ CLEARING ALL CLIP INSTANCE IN ARRANGER

1. Press & hold (SCROLL ▼▲) + [BACK / UNDO].

8 Arranger View

8.4 White Pads for Variations

NOTES

While arranger view generally uses existing, song section coloured clips to build up an arrangement, there is also a 'white' instance clip option. White clips are unique and special clips that can be edited independently and used to add one off fills and variations in an arrangement.

■ CREATING A BLANK WHITE CLIP

1. Press & hold [*PAD*], the clip instance to create + turn (SELECT).
2. The clip instance options available will be selected with the select control. The pad will change its colour based on its section colour in song mode.
3. Select a WHITE clip and then release the pad.
4. A new blank clip instance is created that is not connected to any other clip nor is it featured in the song view.
5. Pressing the clip 'tail', not the left most pad, will switch to clip view, where no notes or sound patterns exist.

■ CREATING A NEW WHITE CLIP VARIATION PATTERN

1. After creating a blank clip, pressing the dimly lit [*PAD*] clip 'tail', not the left most bright pad, will switch to clip view.
2. The clip will currently be a blank instrument clip.
3. The default preset and instrument will be as per the instrument row where the white clip resides in arranger view.
4. Create a new pattern that will form a variation from the other clip instances on the same instrument row. For example a crash cymbal or drum fill for the end of a sequence part.
5. Press [*SONG*] which will return back to the arranger view.
6. The white clip will now host a unique variation from the other clips by playing the one off pattern from the recently created clip.

NOTES

CONVERTING AN EXISTING CLIP INSTANCE TO A WHITE CLIP

1. Press [SHIFT] + [PAD] of an existing coloured clip instance. This will be a clip instance which instead of creating a new variation, will be edited from its existing pattern to form the variation.
2. The clip instance left most pad will turn white. Other 'tail' pads forming its length may be coloured dimly based on the clips event colours.
3. Pressing the dimly lit [PAD] clip 'tail', not the left most bright pad, will switch to clip view.
4. The clip will contain the existing note and sound events and pattern. These can be edited to form a unique variation from the original pattern.
5. Press [SONG] which will return back to the arranger view.
6. The white clip will now host a unique variation from the other clips by playing the one off pattern from the recently edited clip.

8 Arranger View

8.5 Arranger View - Advanced

NOTES

Arranger view is a powerful persona and view within Deluge. Understanding the basics is important to get started. More advanced functions also exist to integrate tightly with song view and align common functions such as song and clip playback.

■ OPENING CLIPS IN ARRANGER DIRECTLY FROM SONG VIEW

1. Select song view [SONG], button is lit solid blue.
2. Press & hold [PAD], the clip row to drag to arranger + press (SONG).
3. The view will switch to arranger.
4. While still holding the [PAD] in arranger view, turn (SCROLL ◀▶) to locate the position to a column across the instrument row.
5. Release [PAD] to drop the clip instance in the arranger grid.

■ OPENING CLIPS IN SONG VIEW DIRECTLY FROM ARRANGER

1. Select arranger view [SONG], [SONG]. Button flashes blue.
2. Press & hold [PAD], the clip instance to drag to song view + press (SONG). The typical use would be to drag over a white clip, which by default doesn't exist in song view.
3. The view will switch to song view.
4. While still holding the [PAD] in song view, turn (SCROLL ▼▲) to locate the position within the clip rows.
5. Release [PAD] to drop the clip into the song grid row position.
6. Once in song view, the clip will change from white to an assigned section and its associated colour. This colour will now be reflected in the clip instance in arrangement view.

SYNCHRONISING PLAYBACK BETWEEN VIEWS

1. In arranger view:-
 1. Press the dimly lit [PAD] clip 'tail', not the left most bright pad, which will switch to clip view.
 2. Pressing [PLAY] after entering clip view this way will start playback in the arranger from the beginning of this clip instance.
2. In arranger view:-
 1. Press [PLAY] to play back the arrangement.
 2. Switch to song view [SONG], button lit solid blue.
 3. The pads will be lit slightly dim while arranger controls the transport playback.
 4. Control can be regained within the song mode. Sections and clips can be triggered in song mode which override the arranger.
3. In song view:-
 1. Press [PLAY].
 2. Press [SONG] which will switch to the arranger view.
 3. Turn (SCROLL ◀▶) to set the playback start position in the arranger view.
 4. Press & hold (SCROLL ◀▶) + [PLAY] to start arranger playback from the new position once the song loop completes.

8 Arranger View

NOTES

■ CHANGING A TRACKS PRESET WHEN IN ARRANGER VIEW

1. Press [AUDITION] pad to hear the instrument / sound for the row.
2. Press & hold [AUDITION] pad for the instrument / row to change + (SELECT) to scroll the presets.

or

2. Press & hold [AUDITION] pad for the instrument / row to change + track type [SYNTH], [KIT], [MIDI], [CV].

or

2. Press & hold [AUDITION] pad for the instrument / row to change + press (SELECT) for an audio track.

8.6 Capturing an entire Song session into Arranger View

Triggering of clips, sections and changing parameters can be performed in song view. This in turn can be captured as clip instances within arranger view. This allows entire performances to be recorded either as a planned production or as an on-the-fly improvisation.

RECORDING INTO ARRANGER DIRECTLY FROM SONG VIEW

1. Select song view [SONG], button is lit solid blue.
2. Press [RECORD] + [SONG] to activate recording*. Both buttons will quickly flash indicating recording to arranger mode is active.
3. During recording:-
 - Switching to clip or arranger view is deactivated.
 - Clips cannot be deleted.
 - Parameters in song view can be changed by holding a clip [PAD] and changing the (UPPER) & (LOWER) controls for the selected parameter. These are recorded but will automatically create a cloned clip version.
 - Adjust external MIDI controllers to record associated parameter changes.
 - Instant-launch a clip by [SHIFT] + [LAUNCH] will be placed in the arrangement as if it had been played from the start of that loop.
 - Play clips of which its instance will be recorded into the arranger in relevant rows. The instances are directly linked to the original so changes later will reflect in the recorded instance. Clone clips later in the arranger to create unique versions.
 - Play an external MIDI controllers live to record notes. These are recorded but will automatically create a cloned clip version.
4. To end recording; press [RECORD] to end playback, or press [PLAY] or press [SONG].

* Arrangement recording will begin from wherever your current scroll-position is in arranger view. Default for new songs is 0. Anything which previously existed to the right of this start-point is immediately deleted to make way for the new recording. [BACK / UNDO] & [REDO] are available functions and can restore whatever arrangement existed previously.

— AUDIO —

9 Audio

9.1 Typical Sampling / Recording Workflow

NOTES

Deluge provides a number of audio recording, playback and editing functions. Audio clips can be recorded and aligned to the timing of other functions. Audio clips should not be mistaken for samples. Samples are raw sounds which can be used within kits and synths. Samples can also be created in other systems and imported for use in Deluge. Audio can be recorded in song and arranger views.

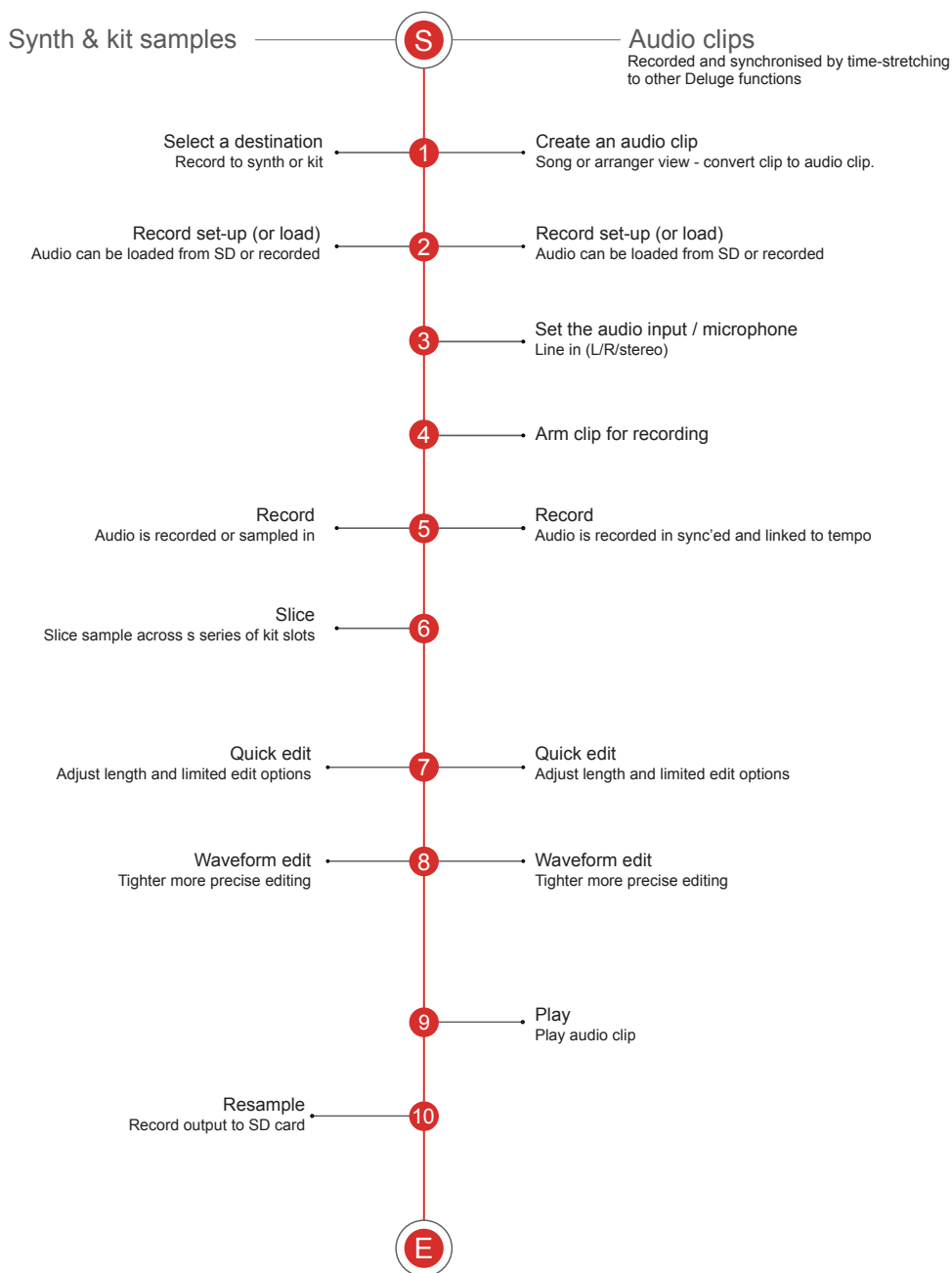

9.2 Getting Audio Into Deluge

There are three main ways to get audio into Deluge. Audio can be used in an oscillator as a source or sampled within kits. Many options exist when using audio.

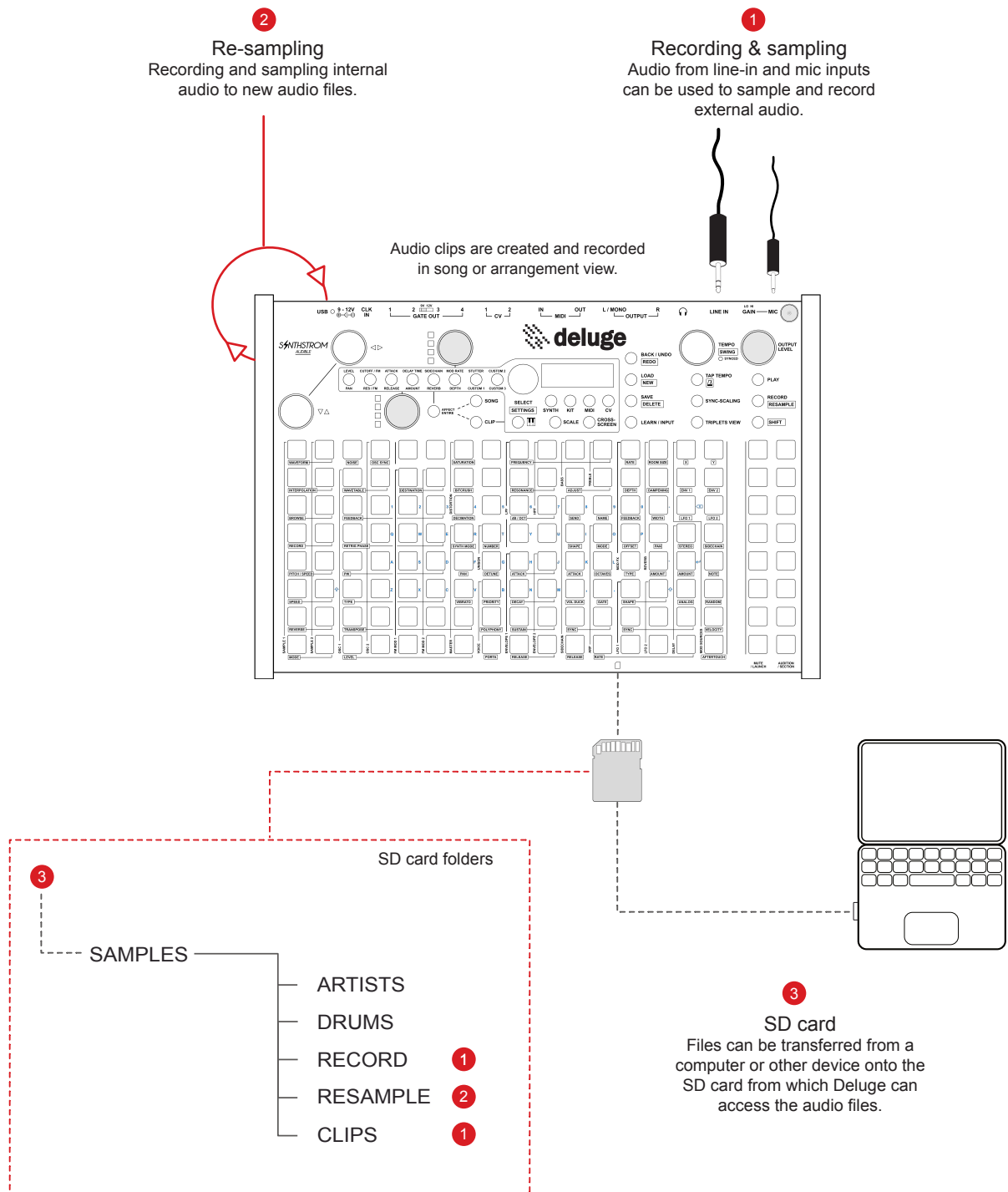

9 Audio

9.3 Loading Samples from SD Card into Audio Clips

NOTES

An audio clip must exist for a sample to be loaded into it from clip view. If an audio clip does not exist, section 9.6 / 9.7 explain how to create one.

LOADING A SAMPLE INTO THE CLIP USING BROWSE SHORTCUT

1. Select audio clip view by pressing any audio clip row [*PAD*] in song view or pressing an audio clip, right part / tail [*PAD*] in arranger view.
2. Within clip view, [*SHIFT*] + [*BROWSE*] from the shortcut grid pads opens the file browser.
3. Navigate to the desired folder on the SD card. The 'Artists' folder is the default location. Turn (*SELECT*) to navigate, press (*SELECT*) to drill into the menu. [*BACK / UNDO*] to back-up.
4. Navigate to highlight the desired sample / audio in-focus. Samples will be auditioned and displayed on the grid in white when in-focus.
5. Press (*SELECT*) to load the audio. This will show on the grid as coloured pads.
6. Press [*PLAY*] to hear the audio sample looping.

LOADING A SAMPLE INTO THE CLIP USING SOUND EDITOR

1. Select audio clip view by pressing any audio clip row [*PAD*] in song view or press an audio clips', right part / tail [*PAD*] in arranger view.
2. Within clip view, press (*SELECT*) from the shortcut grid pads opens the sound editor.
3. Within the sound editor or file browser, turn (*SELECT*) to navigate, press (*SELECT*) to drill into the menu. [*BACK / UNDO*] to back up.
4. Default position is 'SAmP' - sample option. Press (*SELECT*) to access 'FiLE' - file browser.
5. Navigate to the desired folder on the SD card.
6. Press (*SELECT*) when the sample required is in-focus. Samples will be auditioned and displayed on the grid in white when in-focus.
7. The sample selected will load show on the grid as coloured pads
8. Press [*PLAY*] to hear the audio sample looping.

9.4 Deleting Samples

While in the file browser, you can hold shift and press the save button to delete the selected sample - it'll prompt you with "DELE" first.

Remember, this deletes the sample even if it's used in songs, and the Deluge will not notify you whether it is or not being used, so be careful.

■ DELETING A SAMPLE

1. Press [SHIFT] + [*BROWSE*].
2. Navigate to the sample to delete.
3. Press [SHIFT] + [DELETE] to delete.
4. Display will indicate flashing, 'dELE' - delete.
5. Press [SAVE] to confirm.
6. Sample will be deleted.

9 Audio

9.5 Audio Inputs

Audio clips are recorded into Deluge from within song view or arranger View. Deluge records audio through the mic or stereo line-in.

Line In - TRS Connector

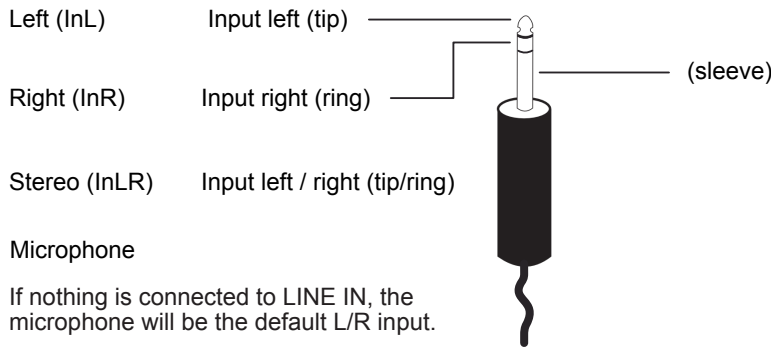

Audio Input Options

Several audio input options are available for recording.

Input	Input Options	Options
Left	LEFt (Default)	The left or mono channel of the Deluge's line or mic input. Use this if using the Deluge's internal mic, or recording a mono source with an unbalanced cable.
	LEFt.	Left dot, enables audio "thru" or "monitoring" on that input channel - echoing the audio that's fed in. The left or mono channel of the Deluge's line or mic input. Use this if using the Deluge's internal mic, or recording a mono source with an unbalanced cable.
Right	riGH	Used if the Deluge's stereo line input is connected as two separate mono inputs.
	riGH.	Right dot, enables audio "thru" or "monitoring" on that input channel - echoing the audio that's fed in. Used if the Deluge's stereo line input is connected as two separate mono inputs.
Stereo	StEr	Stereo line or mic input.
	StEr.	Stereo dot, enables audio "thru" or "monitoring" on that input channel - echoing the audio that's fed in. Stereo line or mic input.
Balanced	bALA	Used when running a mono signal via a TRS cable from a balanced output into the Deluge's line input socket.
	bALA.	Balanced dot, enables audio "thru" or "monitoring" on that input channel - echoing the audio that's fed in. Used when running a mono signal via a TRS cable from a balanced output into the Deluge's line input socket.
Mix	miX	Sources audio from the Deluge's output. Example, other playing tracks. Grabs the audio pre master FX and level adjustment, and without reverb applied. This is usually the best option for "resampling" or "bouncing" existing instrument clips down to a single new audio clip. (Not to be confused with the Deluge's resampling function for recording its output straight to a file.)
Output	oUTP	Deluge audio output post FX and with reverb - same as resampling. For recording audio clips MIX is recommended.
Off	oFF	No audio input, recording disabled.

9.6 Recording into Audio Clips in Song View

Audio can be recorded in song view, which also provides the functionality as a looper. Audio and MIDI looping are possible within song view both to record in and also as a live performance option. Audio clips are recorded and played in-sync with other Deluge functions, typically through time-stretching.

■ CREATING AN AUDIO CLIP IN SONG VIEW

1. Press [SONG] to switch to song view.
2. Press & hold a [PAD] within a clip row. This can be either an existing or blank row. The instrument button will flash indicating the type selected and display will show the preset or MIDI/CV Channel.
3. While still holding the pad, press (SELECT).
4. The track will be converted to an audio clip and the display will show the name, example: 'AUDIO1'. If converting an instrument track, 'CANT' is displayed if notes exist and the track wont be converted.
5. Selecting the audio clip by pressing the row [PAD] will then allow audio to be loaded, recorded, edited etc.

■ SELECTING THE AUDIO IN

1. Press [SONG] to switch to song view.
2. Press & hold [LEARN / INPUT] + [PAD] of a selected audio clip row to record into.
3. Turn (SELECT) to change to the input desired. This should match the physical connection. Example, a mono input would typically be the LEFT input, with LEFT. for input monitoring.
4. If input monitoring is required, a *dot . version* of the left, right, stereo, balanced inputs is available for thru audio monitoring.
5. Display will indicate the selected channel input for the track on which the clip sits.
6. Exit this setting before recording by pressing (SELECT), [BACK], or any [PAD]

■ ARMING AUDIO CLIPS FOR RECORDING IN SONG VIEW

1. Press [SONG] to switch to song view.
2. New blank clips created will automatically be armed by default.
3. Hold [RECORD] to check current status of [LAUNCH] pad associated with the clip row to record into:
 - Flashing coloured eg: magenta - clip is empty, armed and ready to record.
 - Flashing red - clip is armed, ready to record. It will playback as normal in loop but will mute when a new overdub is recorded.
 - Solid or dim colour - unarmed and will not record. Clip may have content already recorded in.
4. Hold [RECORD] + [LAUNCH] pad to arm or disarm any clip row.

■ RECORDING AN AUDIO CLIP IN SONG VIEW

1. Press [SONG] to switch to song view. Ensure audio input is set and clips are armed.
2. [RECORD], button should be on and illuminate red.
3. Press [PLAY]. Recording will start. Play and record buttons will be lit. All armed clips will record.
4. The red recording cursor will travel left to right across the clip rows being recorded. Audio clips must also be unmuted/green for recording to occur.
5. Recording will be continuous and not be limited by any length. Length is set only when previously recorded or existing audio exists when recording within a clip.
6. Press [LAUNCH] pad of any clip row to STOP recording. This clip will be armed to stop at the end of the 'loop' of the original clip length. The clip will then begin to PLAY back from the start.

For details on overdub recording see the details covered in the looper section.

9.7 Recording into Audio Clips in Arranger View

Audio can be also be recorded in arranger view, which provides more structure and arrangement functionality. Ensure audio clips have already been created.

■ CREATING AN AUDIO CLIP IN ARRANGER VIEW

1. Press [SONG] to switch to song view and press [SONG] again for arranger view. Button flashes blue.
2. Press & hold a [AUDITION] Pad. This can be either an existing or blank row. The instrument button will flash indicating the type selected and display will show the preset or MIDI/CV Channel.
3. While still holding the audition pad, press (SELECT).
4. The track will be converted to an audio clip and the display will show the name, example: 'AUDIO1'. If converting an instrument track, 'CANT' is displayed if notes exist and the track wont be converted.
5. Selecting the audio clip will then allow audio to be loaded, recorded, edited, etc.

■ SELECTING THE AUDIO IN

1. Press [SONG] and [SONG] to switch to arranger view.
2. Press & hold [LEARN / INPUT] + [AUDITION] pad of a selected audio clip row to record into.
3. Turn (SELECT) to change to the input desired. This should match the physical connection. Example, a mono input would typically be the LEFT input, with LEFT. for input monitoring.
4. If input monitoring is required a dot . version of the left, right, stereo, balanced inputs is available for thru audio monitoring.
5. Display will indicate the selected channel input for the track on which the clip sits.
6. Exit this setting before recording by pressing (SELECT), [BACK], or any [PAD]

■ ARMING AUDIO TRACKS FOR RECORDING IN ARRANGER MODE

1. Press [SONG] and [SONG] again to switch to arranger view.
2. Tracks will be disarmed by default.
3. Press & hold [RECORD] to see each tracks status.
 - Armed rows - [MUTE] pads illuminate flashing red. Tracks will record audio.
 - Semi-armed rows - [MUTE] pads flashes dim grey-red. Semi-armed meaning armed in theory but wont record as the tracks already contain audio
 - Unarmed clip rows - [MUTE] pads lit dimly coloured. Track is empty and can be recorded into but only when armed.
4. Press [RECORD] + [MUTE] pad to arm or disarm any track row.

■ RECORDING AN AUDIO CLIP IN ARRANGEMENT VIEW

1. Press [SONG] and [SONG] to switch to arranger view. Ensure audio input is set and tracks are armed. [RECORD] should be lit.
2. Press [PLAY]. Recording will start. Play and record buttons will be lit. All armed tracks will record.
3. The red recording cursor will travel left to right across the clips being recorded.
4. Recording will take place into newly created clip-instances, unless a clip already exists.
5. Recording will be continuous and not be limited by any length. Length is set only when previously recorded or existing audio exists when recording within a clip.
6. Press [RECORD] to stop recording, play continues to end of clip.

9.8 Quick Editing Audio in Clip View

Audio clips are displayed on the grid in clip view as a graphical waveforms. A number of basic editing options are available.

■ QUICK EDITING OF AUDIO LENGTH - TIME STRETCH

1. Within [CLIP] view and an audio clip selected. Select from SONG by pressing [PAD] for clip or in ARRANGER pressing the [PAD] tail.
2. Press [SHIFT] + turn (SCROLL ◀▶) Clockwise to 'stretch' the audio length longer.
3. Press [SHIFT] + Turn (SCROLL ◀▶) anti-clockwise to 'shrink' the audio length shorter.
4. Turn (SCROLL ◀▶) to navigate across the sample width.
5. The audio will be time stretched.
6. Press [PLAY] to hear the clip loop.

■ QUICK EDITING OF AUDIO LOOP LENGTH - TRIM / EXTEND

1. Within [CLIP] view and the audio clip selected.
2. Ensure the end of the waveform is in view. Turn (SCROLL ◀▶) to navigate across the sample width.
3. Press [PAD] of the last column showing the waveform. The column will illuminate flashing red which represents the loop point.
4. Press [PAD] of the column to where the loop point should be relocated.
5. To the right of the original 'end' position will add silence. To the left of the original 'end' point will trim the audio.
6. Turn (SCROLL ◀▶) to navigate across the sample width.
7. Pressing a red column pad will remove the red loop point cursor / editor.
8. The audio will NOT be time-stretched when changing loop end point.
9. Press [PLAY] to hear the clip loop.

9 Audio

Audio Clip View - Quick Editing

Audio clips are created in song or arrangement view. Once audio is recorded or loaded in they can be displayed on the grid as a graphical waveform with quick editing options available. Pressing a [PAD] for the clip row or 'tail' in song and arranger view respectively selects the audio clip in clip view. The waveform length on display matches the timing and synchronisation to the grid. Example, an audio waveform may fill one page as it is 1 bar in length. More precise options for editing are available in the waveform editor although this does not sync to grid timing.

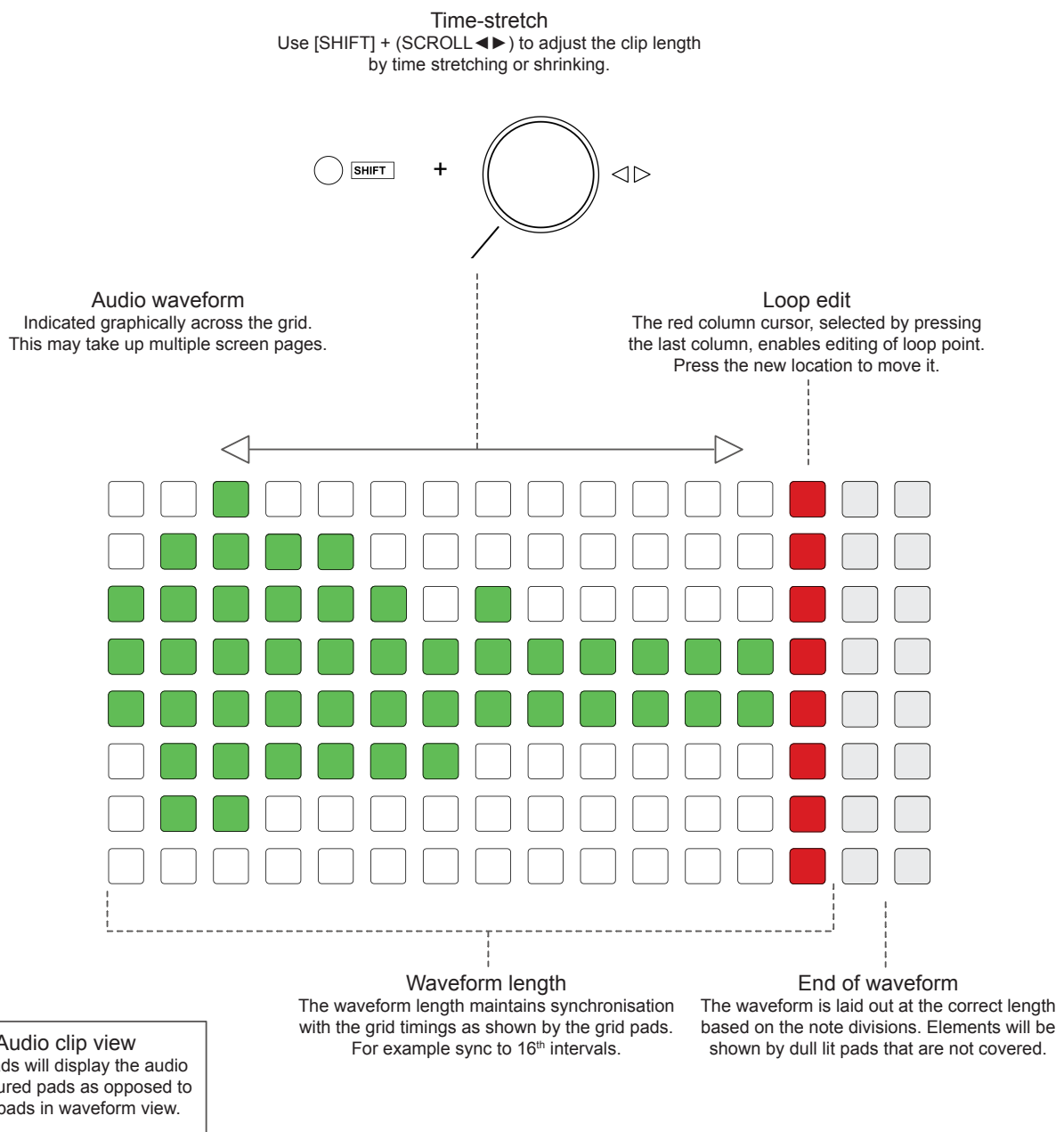

9.9 Sampling & Recording Audio within Kits

Kits are a great environment for sampling audio. Samples can be recorded and arranged into a kit. Kits can be combination of samples or synth sounds.

RECORDING AN AUDIO SAMPLE IN TO A NEW KIT

1. Input will be line-IN or mic (external or internal). The mic gain can be changed on the input switch.
2. Press [SHIFT] + [KIT] from clip view to create a blank a kit clip.
3. The browser will open to select a sample from the SD card or a previous last recent recording may by appear on the grid.
4. Press [RECORD]. Button illuminates flashing red and the display indicates 'rEC' to indicate that recording has started.
5. Press [RECORD] again to end recording. Recording ends and is normalised.
6. The recording is assigned to a row of pads indicated by a green [MUTE].
7. Press [AUDITION] to play back the sample.

RECORDING AN AUDIO SAMPLE INTO AN EXISTING KIT

1. Input will be line-IN or mic (external or internal). The mic gain can be changed on the input switch.
2. Press [KIT] from clip view and selected a kit to record into.
3. Press & hold [AUDITION] pad of blank or selected row + [RECORD].
4. Recording will start. Button illuminates flashing red and the display indicates 'rEC' to indicate that recording in progress.
5. Press [RECORD] again to end recording. Recording ends and is normalised.
6. The recording is assigned to a row of pads indicated by a green [MUTE].
7. Press [AUDITION] to play back the sample.

9 Audio

■ SETTING SAMPLING INPUT MONITORING

1. Press [SHIFT] + [SETTINGS] to open settings menu.
2. Turn (SELECT) to highlight 'rECo' - recording option.
3. Press (SELECT) to drill into the recording menu.
4. Turn (SELECT) to highlight 'moni' - monitoring.
5. Press (SELECT) to open monitoring options.
6. Turn (SELECT) to highlight:
 - ON - 'oN': switches monitoring when recording samples on.
 - OFF - 'oFF': switches monitoring when recording samples off.
 - COND - 'cond' (Default) : conditional monitoring. Recording from a microphone (internal or external) AND headphones connected, monitoring will occur. Recording using the LINE IN input, monitoring will always occur.

SLICING AUDIO ACROSS A NEW KIT

1. Press [SHIFT] + [KIT] from clip view to create a new kit clip.
2. The browser will open to select a sample from the SD card or a previous last recent recording may by appear on the grid.
3. To use a previous recorded samples use (SELECT) to scroll through files and folders. To select another file or folder from within the browser, press [BACK / UNDO] to back out of the recording files and navigate others. Selections may default to previously selected folder / file.
4. Press & hold (SELECT) while the desired sample is in view / in-focus to open the sampling context sub menu.
5. Turn (SELECT) to highlight 'SLiC' - slicer in-focus.
6. Press (SELECT). Number of slices is indicated at which to divide the sample. 16 is default. Turn (SELECT) to adjust, example, to 8.
7. Press (SELECT) to slice the sample across the elected number of pads.

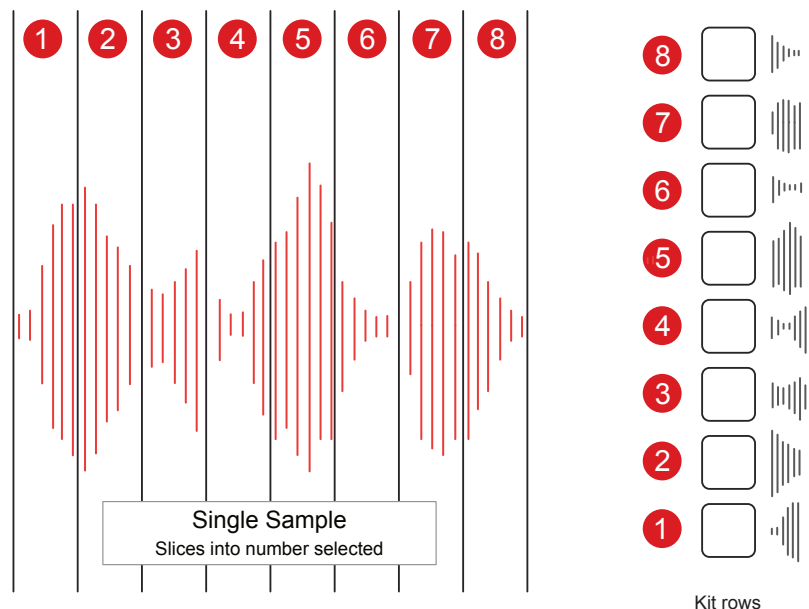

9 Audio

9.10 Sampling into a Synth Instrument

NOTES

Audio can be sampled directly or loaded into a synth as an oscillator source waveform thus enabling creation of melodic instruments. The recorder is accessible from within the sound editor or using grid shortcuts.

LOADING AN AUDIO SAMPLE INTO A SYNTH

1. [SHIFT] + [SYNTH] to create a new synth clip in [CLIP] view. Default is square wave, single oscillator with no filters or effects.
2. [AUDITION] + [LOAD].
3. The load options for note range will be offered:-
 - 'Bot-toP' - bottom-to-top. Audio will be mapped across all notes. This is the default setting and used where a single sample can authentically be mapped over a wide note range.
4. Press (SELECT) to confirm selection.
5. The file browser will open. The most recent recording will be offered or file options. Navigate to the selected audio file. Turn (SELECT) to navigate across folders and files and [BACK / UNDO] to back up, press (SELECT) to drill down into menus.
6. Select a single sample file to load.
7. Press (SELECT) when audio sample is in-focus to load.
8. The audio file replaces the synth oscillator waveform and will be mapped based on the range set. Pressing [AUDITION] pads or keyboard will play automatically tuned to the correct notes.

LOADING MULTI-SAMPLES INTO A SYNTH

1. [SHIFT] + [SYNTH] to create a new synth clip in [CLIP] view. Default is square wave, single oscillator with no filters or effects.
2. [AUDITION] + [LOAD].
3. The load options for note range will be offered:-
 - 'Bot-toP' - bottom-to-top. Audio will be mapped across all notes. This is the default setting and used where a single sample can authentically be mapped over a wide note range.
4. Press (SELECT) to confirm selection.
5. The file browser will open. The most recent recording will be offered or file options. Navigate to the selected audio file. Turn (SELECT) to navigate across folders and files and [BACK / UNDO] to back up, press (SELECT) to drill down into menu's.
6. Select the folder containing the multiple samples to load.
7. Press & hold (SELECT) when the folder is in-focus until the context sub-menu appears.
8. Turn (SELECT) to choose 'mULt' - multi-samples in-focus. Then press (SELECT).
9. The samples will be loaded and pitch automatically detected. They will be mapped across the note range, even filling in gaps if the sample set for the range isn't complete. Pressing [AUDITION] pads will play matched to the correct notes.
10. Range is displayed, example A.1 - 'toP.'

RECORDING AN AUDIO SAMPLE INTO A SYNTH

1. Input will be line-in or mic (external or Internal). The mic gain can be changed on the input switch.
2. Press [SHIFT] + [SYNTH] from clip view to create a blank synth.
3. Press (SELECT) to open synth settings.
4. Turn (SELECT) and with oscillator 1 or 2 (oSC1 / oSC2) selected press (SELECT).
5. Turn (SELECT) to choose 'rEC' and press (SELECT).
6. The recording options for note range will be offered:-
 - 'Bot-toP' - bottom-to-top. Audio will be mapped across all notes. This is the default setting and used where a single sample can authentically be mapped over a wide note range.
4. Press (SELECT) to confirm selection and start recording. Record button illuminates flashing red and the display indicates 'rEC' to indicate that recording has started.
5. Press [RECORD] to end recording. Recording ends and is normalised.
6. The recording is assigned to the oscillator.
7. Press [AUDITION] pads to play back the sample range.

ADJUSTING MULTI-SAMPLE NOTE RANGES

1. Select [SYNTH] in [CLIP] View where a multi-sampled range of samples have been loaded to the synth.
2. Press [SHIFT] + [BROWSE] shortcut to open browser.
3. The range will be displayed in the format “A2-D2”, meaning that the range covers the notes A2 to D2, inclusive of those notes. Sharps are represented with a “.”, and “BOT” and “TOP” are used to inform that the range applies all the way to the bottom or the top.
4. Turn (SCROLL ◀▶) to select the upper or lower note of the band. The selected note will flash.
5. Turn (SELECT) to adjust the note upper / lower band in focus. Neighbouring boundaries will change as needed to accommodate the change.
6. [SHIFT] + turn (SELECT) clockwise to insert a new range above the currently selected one. [SHIFT] + turn (SELECT) anti-clockwise to create a new range below the currently selected one. Band in-focus will indicate flashing.
7. [SHIFT] + [SAVE] to delete the currently selected range.

About sample pitch detection

The Deluge automatically detects the pitch of all samples loaded into “synth” instruments, using this information to set up multi-sample note-ranges and adjust transpose so that the correct pitches are played.

The Deluge’s pitch detection algorithm gets good results on its own, but will then also compare its results to the sample files’ names. If it realises that its pitch detection has got the samples in the wrong order, it will re-evaluate the pitches. For this reason, it’s a good idea to have your samples named alphabetically from low notes to high notes. Numbers and note names are taken into account when looking at the order - e.g. the Deluge knows that “B#2” comes before “A3”, and that “Eb comes before “E”. Only the ordering of the files is important though - the Deluge does not read the actual note names - just looks at the files’ ordering and then uses its pitch detection for the rest.

Some .wav and .aiff files contain tags explicitly stating what note the file contains a sample of. Where these tags are present, they will override the Deluge’s own pitch detection.

9.11 Resampling Deluge Output

Audio can be resampled, recording the output back onto the Deluge's SD card in the folder `SAMPLES / RESAMPLING` as WAV files. This is useful both as a sonic tool, where interesting sounds can be created and the user "resample" them for further use, or to allow the user to make high-quality recordings of compositions or performances. Reopening file browser will default to the last recording for easy access.

■ RE-SAMPLING INSTANTLY

1. Play a song, sound, pattern, audio.
2. `[SHIFT] + [RECORD]`. Record button will flash red.
3. Recording of the Deluge output will immediately be recorded.
4. `[RECORD]` again to stop recording.

■ RE-SAMPLING AT THE SAME TIME AS PLAY

1. Load a song, sound, pattern, audio.
2. `[RECORD] + [PLAY]`. Record button will flash red.
3. Deluge will start to play and at the same time recording of Deluge output will start.
4. `[RECORD] + [PLAY]` again to stop recording at the *loop end* or `[RECORD]` to stop recording instantly while play continues.

■ RE-SAMPLING AT THE SAME TIME AS A VOICE PLAYS

1. Play a song, sound, pattern, audio.
2. Hold `[RECORD] + [AUDITION]` pad or grid `[PAD]` in keyboard view. Record button will flash red.
3. Deluge will play the note and record the output.
4. `[RECORD]` again to stop recording.

Don't confuse resampling which writes to the SD card directly with recording MIX or OUTF outputs which follow Deluge standard recording process.

9 Audio

9.12 Waveform View & Detailed Audio Editing

NOTES

Audio samples and clips can be displayed and edited on the grid in clip view as a graphical waveform. Waveform editor [SHIFT] + [WAVEFORM] is a tool for more precise editing. Quick editing will be able to cover some basic functions but a more in depth precise method is provided within the waveform view. Editing functions are available from the shortcut or the nested menus.

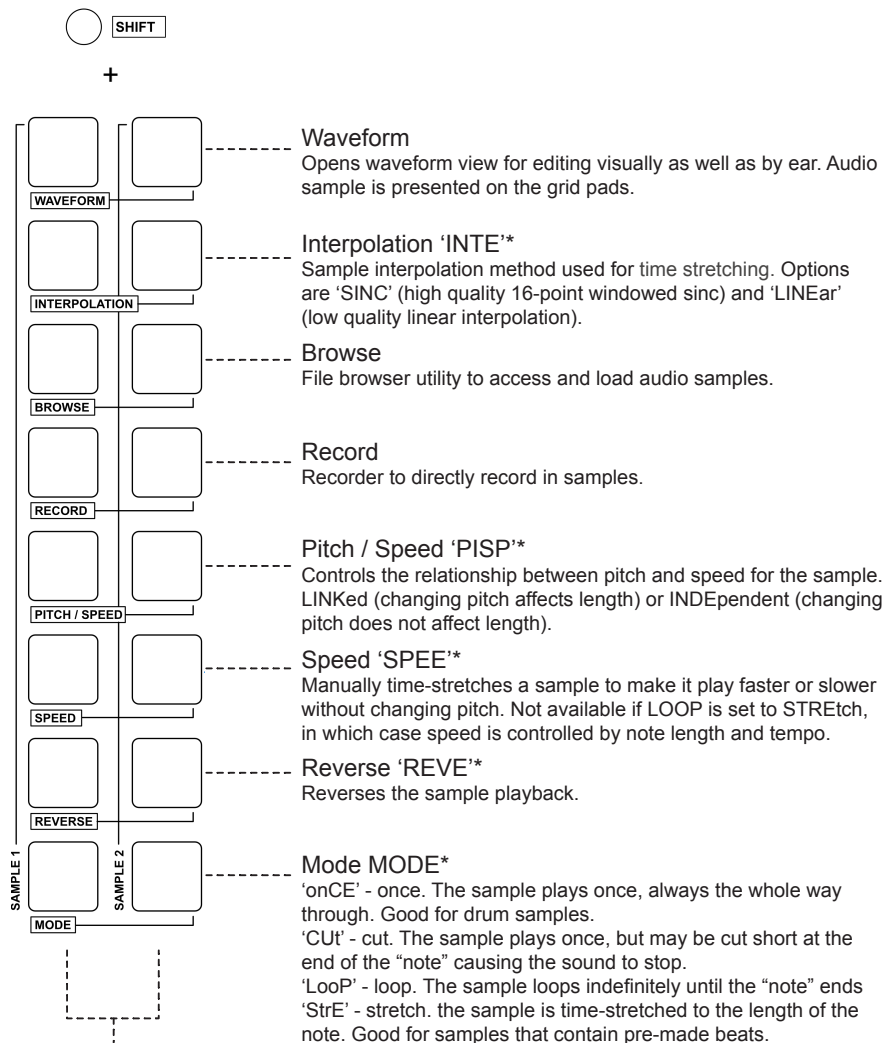

Sample 1 & 2

Representative of the synth engine and each of their oscillator's audio samples. Sample 1 is by default for general audio editing.

* Items exist in the sound editor menu as well as from the shortcut pads. Label shown in capitals indicates what is name used within the sound editor SAMPlE Menu.

Waveform Editor

Samples and audio clips can be displayed on the grid as a graphical waveform with editing options. The audio length, unlike the quick waveform editor, does not represent the timing of the sample with reference to the grid. Press [SHIFT] + [WAVEFORM]. Turn (SCROLL ◀▶) to scroll waveform and press & turn (SCROLL ◀▶) to zoom.

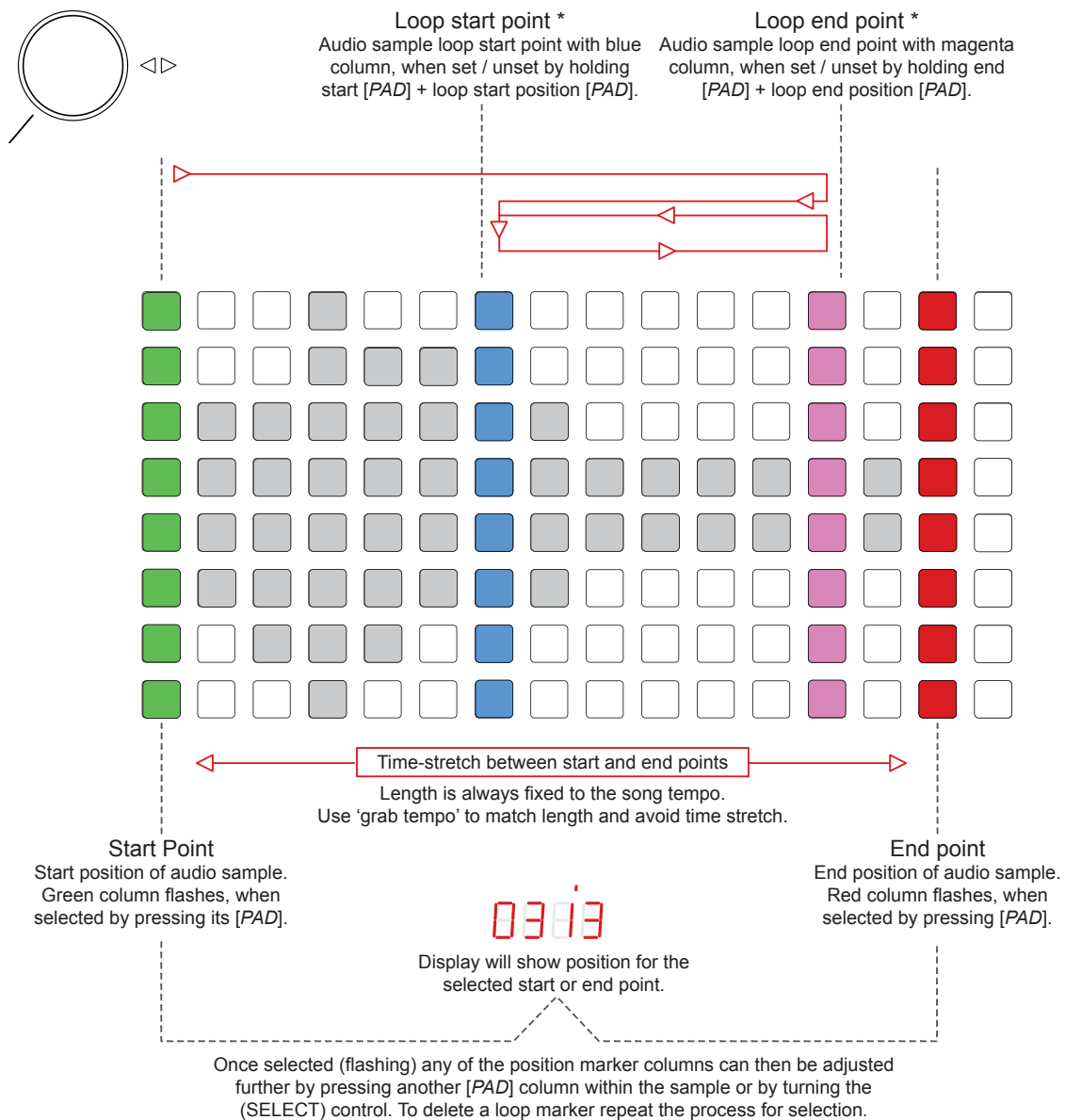

Waveform view
Grid pads will display the audio on white pads as opposed to coloured pads in quick audio clip edit view.

* Loop markers available for samples but not available for audio clips.

■ WAVEFORM EDITING LENGTH WITH START & END POINTS

Audio clip length is tied to the song's tempo - e.g. "1 bar long" - and will not change. So, changing these waveform start and end points or tempo is likely to cause the waveform to be time-stretched when played.

1. With the audio clip in-focus i.e. after recording or loading.
2. Press [SHIFT] + [WAVEFORM].
3. Grid will show audio in graphical form indicated by white pads.
4. The START position is indicated with a green column.
5. The END position is indicated with a red column.
6. To adjust start or end, press the START or END column [PAD] to select it - column flashes. Press a new location [PAD] to move the position to.
7. Display will indicate the position of the selected marker.
8. [BACK / UNDO] to exit waveform editor.

■ 'GRABBING TEMPO' TO AVOID TIME-STRETCHING

Audio clip length is tied to the song's tempo and as such will be time-stretched when adjusting markers. Grabbing the tempo of an audio clip will avoid time-stretching.

1. Within [CLIP] view, press (TEMPO) + [PAD] on the grid.
2. Within [SONG] view, press (TEMPO) + [PAD] on the clip's row.

This may be useful when loading an existing audio file into an audio clip and wishing to set the song to its tempo, or to return to the original tempo at which the clips were recorded if the tempo has since been changed, or after minor edits to an audio clip's waveform's start and end points (see previous section).

When working with the markers it is recommended to start with the end marker adjustment first. Zoom out to work at a wider level and zoom in as finer adjustments are needed.

■ ADDING / LOCATING WAVEFORM LOOP MARKERS

Loop markers can be set for samples but not audio clips.

1. With the sample in-focus i.e. kit sample.
2. Press [SHIFT] + [WAVEFORM].
3. Grid will show audio in graphical form indicated by white pads.
4. To create a LOOP START, press & hold [PAD] for the green start column + press [PAD] for column to locate the LOOP START marker. Marker for loop start is illuminated blue.
5. To create a LOOP END, press & hold [PAD] for the red end column + press [PAD] for column to locate the LOOP END marker. Marker for loop end is illuminated magenta.
6. Play sample, for example press [AUDITION] for the kit row sample in-focus.
7. Sample will play from START, then RESTART at LOOP END (or END if no loop exists) and then play a loop beginning at LOOP start.

■ DELETING WAVEFORM LOOP MARKERS

Loop markers can be set for samples but not audio clips.

1. With the sample in-focus i.e. kit sample.
2. Press [SHIFT] + [WAVEFORM].
3. Grid will show audio in graphical form indicated by white pads. Loop markers will be blue and magenta columns.
4. To delete LOOP START marker, press & hold [PAD] for the green start column + press [PAD] for LOOP START column.
5. To delete LOOP END, press & hold [PAD] for the red end column + press [PAD] for LOOP END column.

9 Audio

9.13 Sample Playback Modes

NOTES

Playback of audio can be reversed and also played back in several in several modes:-

- 'onCE' - once. The sample plays once, always the whole way through. Good for drum samples and short 'hits'. Samples shorter than two seconds will by default be set to ONCE, to behave as a one-shot sample: any time the sample is triggered, the whole sample will play.
- 'CUt' - cut. The sample plays once, but may be cut short at the end of the "note" triggering the sound. Samples longer than two seconds will be set to CUT mode, to play only as long as the user is holding down the row's audition pad - or as long as a sequenced note is sounding on that row.
- 'LooP' - loop. The sample loops indefinitely until the "note" ends.
- 'StrE' - stretch. The sample is time-stretched to the length of the note. Good for samples that contain pre-made beats.

Some .wav and .aiff files contain tags specifying sample loop points. The Deluge will read these if they are present. See waveform view for more info.

REVERSING PLAYBACK

1. With a synth type set to sample and a file loaded and in-focus use shortcuts [SHIFT] + [REVERSE] for sample 1 or sound editor - (SELECT) > OSC1 > REVE.
2. Turn (SELECT) to adjust 'rEVE' - reverse between on and off. On meaning the audio is reversed.

SETTING PLAYBACK MODE

1. With a synth type set to sample and a file loaded and in focus use shortcuts [SHIFT] + [MODE] for sample 1 or sound editor - (SELECT) > OSC1 > 'modE'.
2. Turn (SELECT) to adjust the 'modE' - mode. The options are 'onCE' - once, 'LooP' - loop, 'StrE' - stretch, 'CUt' - cut.

9.14 Live Audio Input

As well as using the audio inputs to capture and record audio, it may be utilised as a live sound source, and all other features of the Deluge's sound engine may be applied to it. This applies to either of Deluge's line input, external microphone input, or internal microphone.

■ USING A LIVE AUDIO INPUT SOURCE IN CLIP VIEW

1. [CLIP] view - examples using an synth oscillator.
2. [SHIFT] + [SYNTH] to create a blank new synth clip.
3. Press [SHIFT] + [TYPE] shortcut to access the waveform type for oscillator 1.
4. Turn (SELECT) to choose the waveform or source. In this example 'in' - in, is selected to capture the internal microphone input.
5. Press & hold an [AUDITION] pad to enable the oscillator to trigger and hence, hear the sound.
6. Speak into the mic. If other inputs are connected and set as the audio source these are applied the same way. The sound can be heard through the synth engine.
7. Playing [AUDITION] for middle 'C' - C3 will play the sound exactly as its input. Pitch will shift for the audio corresponding to any other note played.

■ MONITORING AUDIO THRU IN ARRANGER

1. In [ARRANGER] view, button flashes blue.
2. Press & hold [AUDITION] for an empty track + press (SELECT) to convert to an audio track.
3. Press [LEARN / INPUT] for the audio track + [AUDITION] + turn (SELECT) and choose an input with '.' after its name. This signifies monitored input.
4. Apply the same in SONG view but use a row [PAD] of the clip row instead of the [AUDITION] pad in arranger view.

9.15 Time-Stretching & Pitch Shifting

As well as using the audio inputs to capture and record audio, these may also be time-stretched and pitch shifted.

Time-stretch and pitch shift settings are found in the sound editor. Using audio and in particular using your own samples with the Deluge requires a more detailed understanding of time-stretching and pitch shifting.

By default, when you load a sample on the Deluge, its pitch and speed are linked. If you change its pitch up or down, the sample will become shorter or longer, respectively;-

- Time-stretching. To manually shorten or lengthen a sample within a synth without affecting the pitch, adjust the SPEED parameter - either under SAMPLE 1 in the shortcut grid, or under OSC1 in the sound editor's menu. Manually time-stretching a sample can make it play faster or slower without changing pitch. Not available if MODE is set to 'STREtch', in which case speed is controlled by note length and tempo.
- Independent pitch and speed control. The sample's pitch and speed can be treated completely independently, so that adjusting the pitch will not affect speed or length. Enter the "PITCH / SPEED" shortcut for "SAMPLE 1", or navigate to OSC1 -> PISP in the sound editor. The default option is 'LINKed'. It may be changed to 'INDEpendent'.
- Sample time-stretching to play in-sync with Deluge's current tempo. This works by selecting the mode to 'StrE' - stretch within in the MODE settings, under SAMPLE 1 in the shortcut grid, or under OSC1 in the sound editor's menu. Creating a "note" of the sample, will default to a long length (typically 1 bar, 2 bars, or 4, etc...). When playing, the sample will be time-stretched to occupy the entire length of its "note", at whatever tempo the Deluge is set to. This 'note' can be manually shortened or lengthened to stretch the sample to a shorter or longer time.
- In the previous step, setting sample MODE to 'STREtch' automatically makes pitch and speed independent, so that the resulting time stretching does not affect the sample's pitch, which is a common requirement. Another option, however is available that means that when the speed of the sample changes along with the Deluge's tempo, its pitch also goes up or down, just like speeding up or slowing down a record. This is set by by restoring the settings to PITCH / SPEED or PISP parameter and setting it to 'LINKed' again. Pitch and speed are again linked.

NOTES

TIME-STRETCHING

1. With a synth type set to sample and a file loaded and in-focus use shortcuts [SHIFT] + [*SPEED*] for sample 1 or sound editor - (SELECT) > OSC1 > SPEEd.
2. Turn (SELECT) to adjust the 'SPEE' - Speed setting. Range -48 to 0 to +48. Default is 0.

INDEPENDENT PITCH / SPEED CONTROL

1. With a synth type set to sample and a file loaded and in-focus use shortcuts [SHIFT] + [*PITCH / SPEED*] for sample 1 or sound editor - (SELECT) > OSC1 > PiSP.
2. Turn (SELECT) to adjust the 'PiSP' - pitch & speed setting to 'indE'. Options are 'LinK' - linked or 'indE' - independent.

TIME-STRETCHING TO MATCH CURRENT TEMPO

1. With a synth type set to sample and a file loaded and in-focus use shortcuts [SHIFT] + [*MODE*] for sample 1 or sound editor - (SELECT) > OSC1 > modE.
2. Turn (SELECT) to adjust the 'modE' - mode setting to 'StrE'. This automatically makes pitch and speed independent. Options are 'Loop' - loop, 'StrE' - stretch, 'CUt' - cut, 'onCE' - once.

— LOOPING —

10 Looping

10.1 Deluge Looping Overview

Looping is the process of recording, overdubbing and playing clips in order to layer up into a continuous and more complete arrangement. The Deluge has steps automated to simplify the looping process which manages the clip recording and playback in-sync. Deluge looping includes both audio and instruments to record sessions both for live improvisation and operates within song view.

External MIDI Foot Controller
An external MIDI foot switch or controller is an ideal accompaniment to operate the generic looper controls. Some Deluge controls are set to accept global commands from external sources including UNDO, REDO, LOOP & LAYER as well as PLAY/STOP, RECORD, TAP, RESTART.

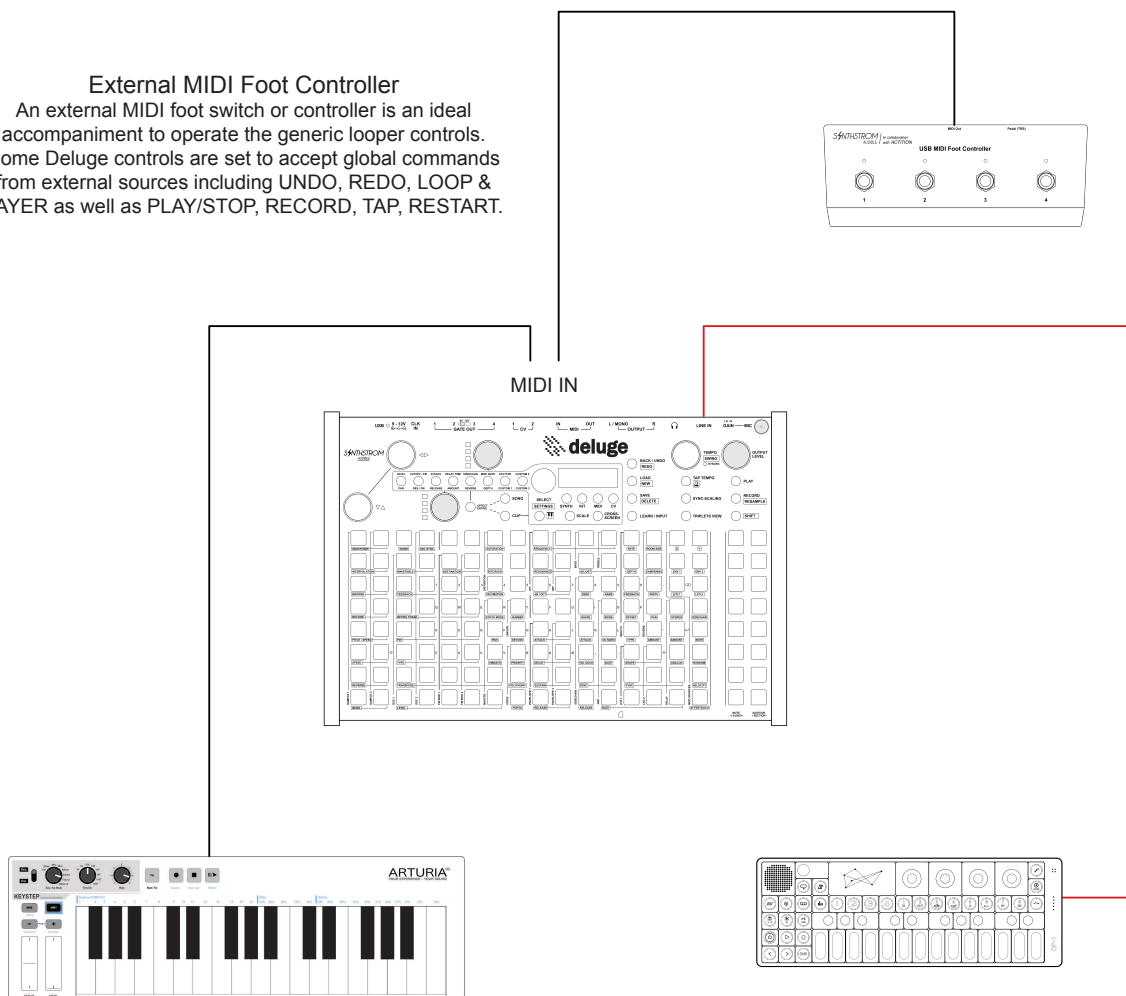
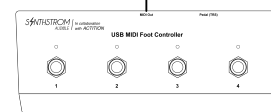

External MIDI Keyboard
With the MIDI input connected to an external keyboard or drum pad will allow sampling and looping of recorded MIDI in.

External Synth or Instrument
An external audio source can be sampled in and used to loop along side other Deluge instruments or other recorded or loaded samples.

Recording Instrument Clips
Recording can be made by using:-
1. Internal keyboard
2. Audition pads
3. External MIDI controller

Recording Audio Clips
Recording can be made by using:-
1. Line in and associated options
2. Internal microphone
3. External microphone

10.2 Looper Workflow

The workflow for looping is simple, but the techniques and your own process should be developed as part of the creative performance. This workflow is one way to use looping within Deluge. These are only the fundamental steps, shown for audio looping.

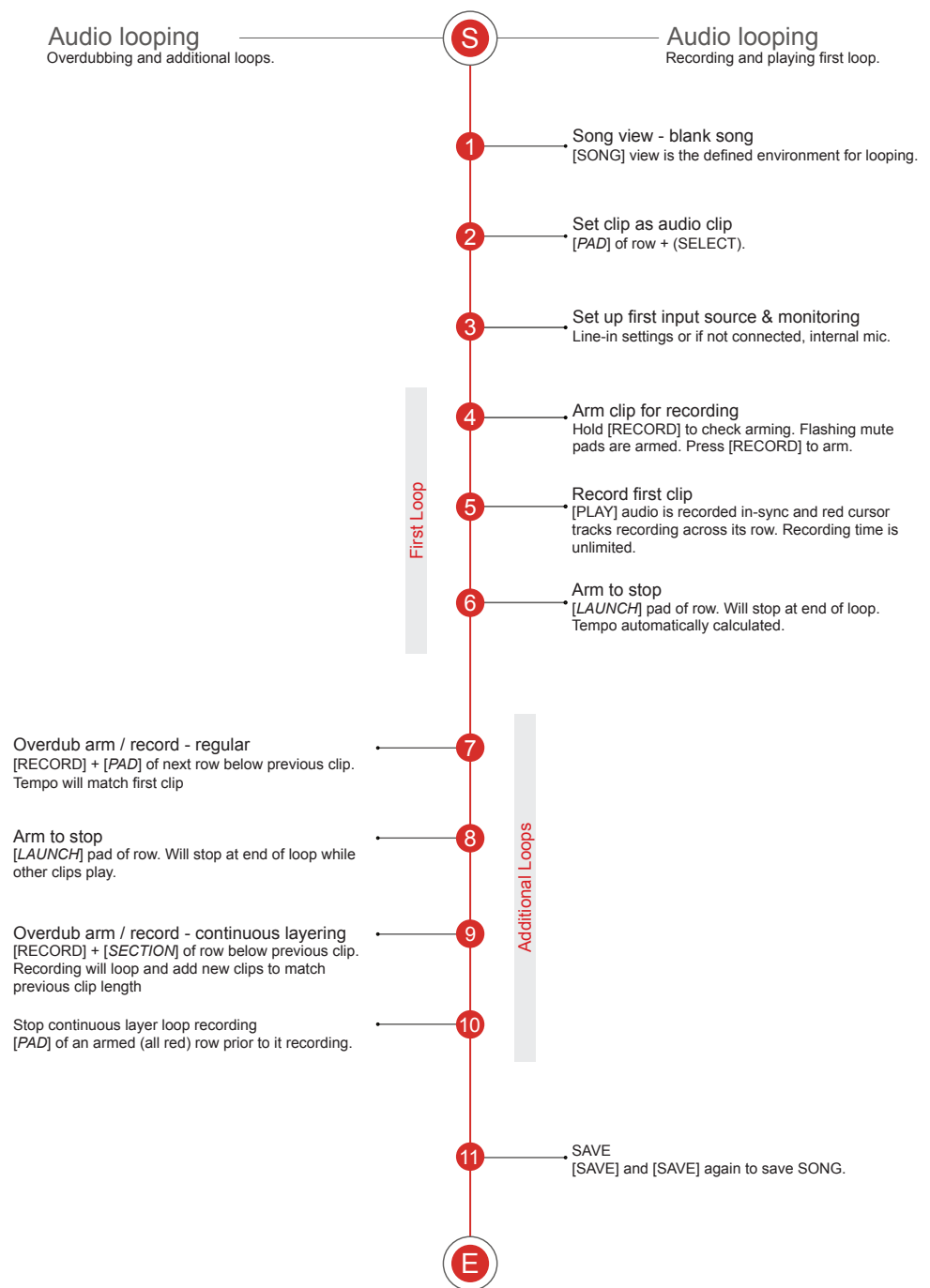

10 Looping

10.3 Basic Looping

NOTES

Loop recording follows a similar process to recording audio clips and samples. The looper environment is [SONG] view.

RECORDING A BASIC FIRST AUDIO LOOP

1. [SHIFT] + [NEW] to select a new song. [NEW] to confirm.
2. [SONG] to select song view. Button illuminates blue.
3. Hold [PAD] + press (SELECT) of the clip row to change to an *audio* clip.
4. Set the audio input channel
 - Hold [LEARN / INPUT] + press [PAD] of the clip row to set the input.
 - Example, LEFT for mono input from line-in or LEFT. (dot) for mono input from line-in, monitored.
 - Press [BACK / UNDO] when complete.
5. Set arming status
 - Hold [RECORD] to check current status of [LAUNCH] pad associated with the clip row to record into.
 - Flashing coloured eg: magenta - clip is empty, armed and ready to record.
 - Flashing red - clip is armed, ready to record. It will playback as normal in loop but will mute when a new overdub is recorded.
 - Solid dim colour - unarmed and will not record. Clip may have content already recorded in.
 - Press [RECORD] + [LAUNCH] pad to arm the clip.
6. Press [RECORD], button illuminates red. Ensure an audio input is present to record.
7. Press [PLAY] to start recording. Recording of the audio input will continue indefinitely until stopped.
8. Press [LAUNCH] to stop at the recording. Tempo of recording is automatically calculated and set.
9. Clip will stop recording and the record button will turn off. Playback of the recorded clip will continue to loop and to allow future overdubs.

Regular & Continuous Overdubbing

Use the global command 'LOOP' for regular overdub looping and 'LAYER' for continuous loop overdubs.



Audio Loop Recording

Audio is recorded into the clip continuously until the recording is stopped. When loop recording mute / launch stops recording.

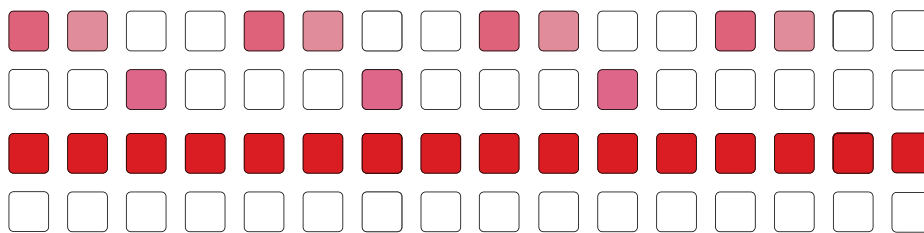

Loop

Audio is recorded into the clip which will loop on play when recording is complete.

Armed Pending Record

A clip row will be indicated red until the loop ends and recording starts.

Regular Overdubs

A new overdub can be recorded into a clip row below the existing clip, triggered by [RECORD] + [PAD]. Recording will be in-time with the original clip and end when launch pad is pressed.

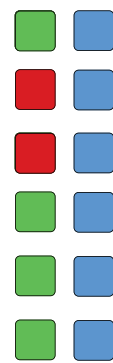

Arming Clip

Holding [RECORD] will indicate the arming status by the [LAUNCH] pad colour. [RECORD] + [MUTE] to change. Arming sets the row in ready to record state. Only empty rows will be armed and the mute / unmute status affects overdub automatic playback state.



Recording

Recording will be indicated by a red cursor tracking the recording position.

Continuous Overdubs

New continuous overdubs can be recorded into a series of new clips below the existing original clip, triggered by [RECORD] + [SECTION]. Recording will continue on subsequent rows and be in time with the original clip.

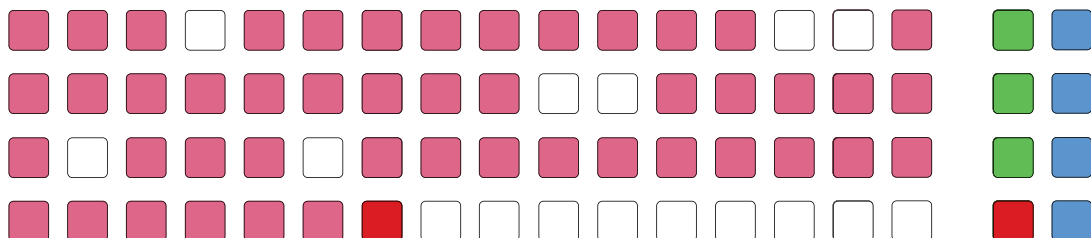

10 Looping

The first recorded clip sets the length and tempo. Subsequent overdubs will fall into line with the original first loop. Setting the arming state will dictate whether the overdubs automatically play all together or are muted. Overdubs create new clips underneath the 'original'.

RECORDING AUDIO CLIPS 'PEDAL STYLE'

1. [SONG] to select song view. Button illuminates blue.
2. Ensure no other clip rows are playing and metronome is off and Deluge is a sync leader.
3. Press [RECORD] + [PLAY] of the clip row to record
4. Ensure the audio is playing at the input which will be recorded.
5. Press [LAUNCH] pad of the grid row to stop recording.
6. Recording will end and playback will continue. Tempo will be calculated and will flash on the screen.

RECORDING A REGULAR AUDIO OVERDUB LOOP

1. [SONG] to select song view. Button illuminates blue.
2. The first audio loop is created as per the previous steps 1-6, 'Recording a Basic First Audio Loop'. Original first loop should be playing.
3. Press [RECORD] + [PAD] of the clip row below the original to arm it for recording - row lit red. Recording will automatically start when the original clip loop restarts. Red recording cursor tracks the position.
4. Ensure the audio is playing at the input which will be recorded.
5. Press [LAUNCH] to stop recording.
6. Recording will stop and playback will continue. Depending upon original clip arming status, new clip will either play alone (original muted) or play together in conjunction with the original.
7. Overdubbing can continue manually, one clip at a time by repeating steps 3-4.

RECORDING CONTINUOUS AUDIO OVERDUB LOOPS

1. [SONG] to select song view. Button illuminates blue.
2. The first audio loop is created as per the steps 1-6, 'Recording a Basic First Audio Loop'. Original first loop should be playing.
3. Press [RECORD] + [SECTION] of the clip row below the original to arm it for recording - row lit red.
 - Recording will automatically start when the original clip loop restarts. Red recording cursor tracks position.
 - Additional clip rows will automatically be created at a fixed length.
 - More layers will be built until stopped.
1. Ensure the audio is playing at the input which will be recorded.
2. Press [PAD] of the grid row currently armed to record - the red row.
3. Recording will end and playback will continue.

GRABBING TEMPO FROM A LOOPS AUDIO CLIP

1. [SONG] to select song view. Button illuminates blue.
 2. Press & hold [TEMPO] + [PAD] of the clip row
- Or
1. Within clip view, press & hold [TEMPO] + Any [PAD] of the clip.

Overdub loops are technically individual audio clips and as such they can be muted, deleted, and have effects applied. Undo / redo can also be applied to each overdub step.

10 Looping

10.4 Using a Foot Controller

NOTES

Loop recording carries a specific workflow and a foot controller when recording and playing loops especially live is a useful accessory. Guitarists for example can control the loop recording while concentrating hands-on with their guitar. Global MIDI commands provide an easy interface between Deluge and a MIDI foot switch.

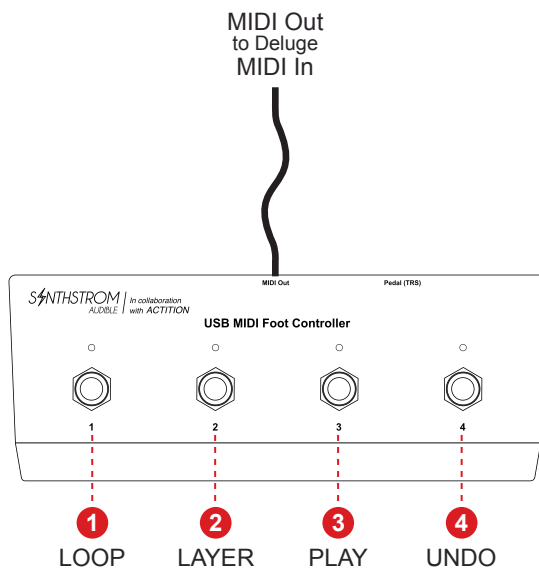

Menu	Command Option	Deluge Manual Control	Description
Global MIDI Commands	PLAY	[PLAY]	Play / stop playback.
	rEST	Press (SCROLL ◀▶) + [PLAY]	Restart playback, if already playing.
	rEC	[RECORD]	Record
	tAP	[TAP TEMPO]	Tap tempo to capture a tempo based on taps.
[SHIFT] + (SELECT)	Undo	[BACK / UNDO]	Reset the last state, undo the prior action.
MIDI > CMD	rEdo	[SHIFT] + [REDO]	Restore the last state, redo the prior action.
	LooP	<i>Triggers a process</i>	Triggers a process the same as performing regular looping and overdubs.
	LAYE	<i>Triggers a process</i>	Triggers a process the same as performing continuous looping and overdubs.

This is one example of a looper pedal set up. Many options exist. Note data must be sent for commands to work with other MIDI controllers.

SETTING UP AN EXTERNAL FOOT CONTROLLER FOR LOOPING

1. Connect the foot switch to the MIDI in connection of Deluge while Deluge is powered off.
2. Power up the Deluge.
3. Press [SHIFT] + press (SELECT) to open the settings menu.
4. Navigate to MIDI settings, turn (SELECT) and navigate to 'CMD'.
5. With 'CMD' in-focus, press (SELECT) to open the global MIDI command menu options.
6. Choose the option to map to the external switch: Example: switch 1 = loop, switch 2 = layer, switch 3 = play, switch 4 = undo. This will be dependant on the device connected and number of switches.
7. With the option in-focus press (SELECT) and the [LEARN / INPUT] button will blink indicating it is available for mapping. 'nOnE' - NONE displays if no MIDI note or channel is currently assigned.
8. Press & hold [LEARN / INPUT] and press the associated switch on the external MIDI foot controller.
9. The display will indicate 'SEt' - SET to show the setup is now complete and the switch is mapped to the specific function.
10. To unmap the command, turn (SELECT) when the function setting is in-focus or set it to a new input.

LOOP v LAYER Global Commands

Two main modes exist for loop recording with overdubs. *Regular*, which captures singular audio clip loops manually or *continuous* which automates the ongoing recording of additional fixed audio clips. Global commands enable single MIDI inputs to trigger the looping processes when using external gear such as a foot switch.

LOOP

Acts in the same way as regular loop recording and overdubbing. Steps triggered are:-

- If playback was not previously active, start playback and begin recording on any clip(s).
- If recording is in progress, will finish recording of a clip (or overdub) - either arming it to stop recording soon, or immediately "closing" a tempo-determine first loop.
- Create an overdub from the 'original' last clip / overdub that was recorded. This will overdub in a clip directly below If playback is active but no recording in progress. If you wish to manually select which clip the overdub will be created from, hold down one of its main 16 pads in song view and then send the LOOP command.
- Delete an overdub if one is pending to begin recording a clip - all red row in song view.

LAYER

Acts in the same way as continuous layer loop recording and overdubbing. Steps triggered are:-

- If playback was not previously active, start playback and begin recording on any clip(s).
- If recording is in progress, will finish recording of a clip (or overdub) - either arming it to stop recording soon, or immediately "closing" a tempo-determine first loop.
- Create overdubs from the 'original' last clip / overdub that was recorded. This will overdub in clips directly below If playback is active but no recording in progress. If you wish to manually select which clip the overdub will be created from, hold down one of its main 16 pads in song view and then send the 'LAYER' command.
- Delete an overdub if one is pending to begin recording a clip - all red row in song view.

10.5 Audio Loop Margins

The Deluge introduces a very short crossfade, beginning just before the loop-point on audio clips. This reduces any audio ‘click’, especially low frequency and / or mismatched audio loop point transitions. Time-stretched or pitch-shifted audio has the same algorithm applied to maximise sound quality. These margins can only be applied if the waveform extends slightly further back in time than the loop’s start-point and ideally extends slightly further forward than its end-point too.

Margins are enabled ON by default.

Setting menu: rEC - Record - Record > mArG - Margins. Option On/Off.

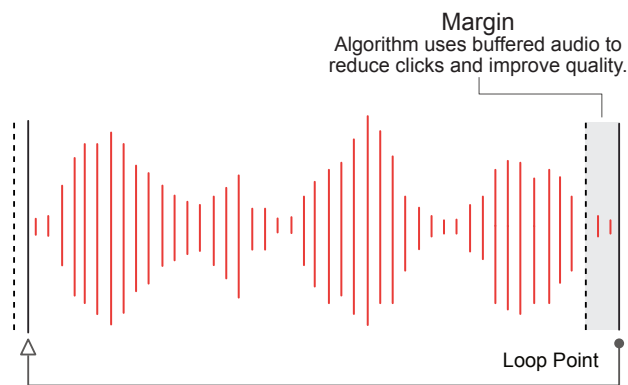

When margins are on, all audio clips recorded from external input sources (i.e. not MIX or OUTPUT), will have these extra short “margins” of audio recorded. The Deluge will even retrieve a few milliseconds of audio data from a buffer in order to have the waveform extend further back in time than the point at which the user pressed the button to begin the recording. This extra audio is simply written into the WAV file as part of the main waveform, along with tags indicating the intended actual start and end points - meaning that the file will be treated correctly if later loaded into another Deluge project. Other software / hardware may or may not know what to do with these tags; if you're intending to use your Deluge-recorded audio clips in other devices with maximum ease, you have the option of disabling the “margins” feature - but then of course the benefits described above would be lost.

The click-avoiding crossfade described above isn't applicable when an audio clip is played for the first time though, with no previous iteration to crossfade from - so a click may occur at its very start if the waveform doesn't have a zero-crossing right at that point. To help with this, audio clips have an attack setting which controls a short fade-in - defaulting to slightly on when margins are in use for a given recording, or off otherwise.

10 Looping

10.6 Instrument Loop Recording

NOTES

Instrument clips can also be loop recorded. As with audio looping an external controller is advised to get the maximum benefits from looping. In this case an external keyboard controller or drum pad controller assists in a good looping workflow, although it is possible to use grid pads, internal keyboard view and audition pads. The process in loop recording follows a similar process as recording audio. It is highly recommended to use the metronome feature when recording a first loop.

RECORDING A REGULAR INSTRUMENT FIRST LOOP

1. [SONG] to select song view. Button illuminates blue.
2. The first instrument clip is created by pressing a row in song view.
3. The clip can be set to [SYNTH] or [KIT].
4. [SONG] - control of looping is in song view.
5. Set arming status of instrument clip.
 - Hold [RECORD] to check current status of [LAUNCH] pad associated with the the clip row to record into.
 - Flashing red - clip is empty, armed and ready to record and will record with auto extend enabled.
 - Solid dim green - clip is armed, and ready to record fixed length.
 - Press [RECORD] + [LAUNCH] pad to toggle clip arming mode
6. If not selected, Press [RECORD], button illuminates red.
7. Press [PLAY] to start recording. First recording of the instrument will start.
8. Play the notes / kit to record. Switching between [SONG] view and [CLIP] view to use internal pads, internal keyboard is possible.
9. In [SONG] view, press [LAUNCH] pad of clip or [RECORD] to stop recording.
10. Clip will stop recording and the record button will turn off. Playback of the recorded clip will continue to loop and to allow future overdubs. Clips with the same instrument will be muted.

RECORDING A REGULAR INSTRUMENT OVERDUB LOOP

1. After recording the first loop and with PLAY and RECORD on / lit. Clips playing.
2. Play the notes / kit to record. Switching between [SONG] view and [CLIP] view to use internal pads, internal keyboard is possible.
3. In [SONG] view, press [RECORD] + [PAD] of the clip row below the original to arm it for recording - row lit red. Recording will automatically start when the original clip loop restarts. Red recording cursor tracks position.
4. Ensure the instrument is playing which will be recorded.
5. In [SONG] view press [LAUNCH] or [RECORD] to stop recording.
6. [RECORD] will stop and playback will continue. Instrument overdubs will always mute the original as they share the same instrument.
7. Overdubbing can continue manually, one clip at a time by repeating steps 3-5.

RECORDING CONTINUOUS INSTRUMENT OVERDUB LOOPS

1. [SONG] to select song view. Button illuminates blue.
2. The first instrument loop is created as per previous steps.
3. During playback, press [RECORD] + [SECTION] of the clip row below the original to arm it for recording - row lit red.
 - Recording will automatically start when the original clip loop restarts. Red recording cursor tracks position.
 - Additional clip rows will automatically be created at a fixed length.
 - More layers will be built until stopped.
4. Ensure the instrument is playing which will be recorded.
5. Press [PAD] of the grid row currently armed to record - the red row.
6. Recording will end and playback will continue.

— EFFECTS —

11 Effects

11.1 Effects Architecture

SD CARD
Audio samples streamed to Deluge

Deluge: Effects Architecture
64MB of internal working memory

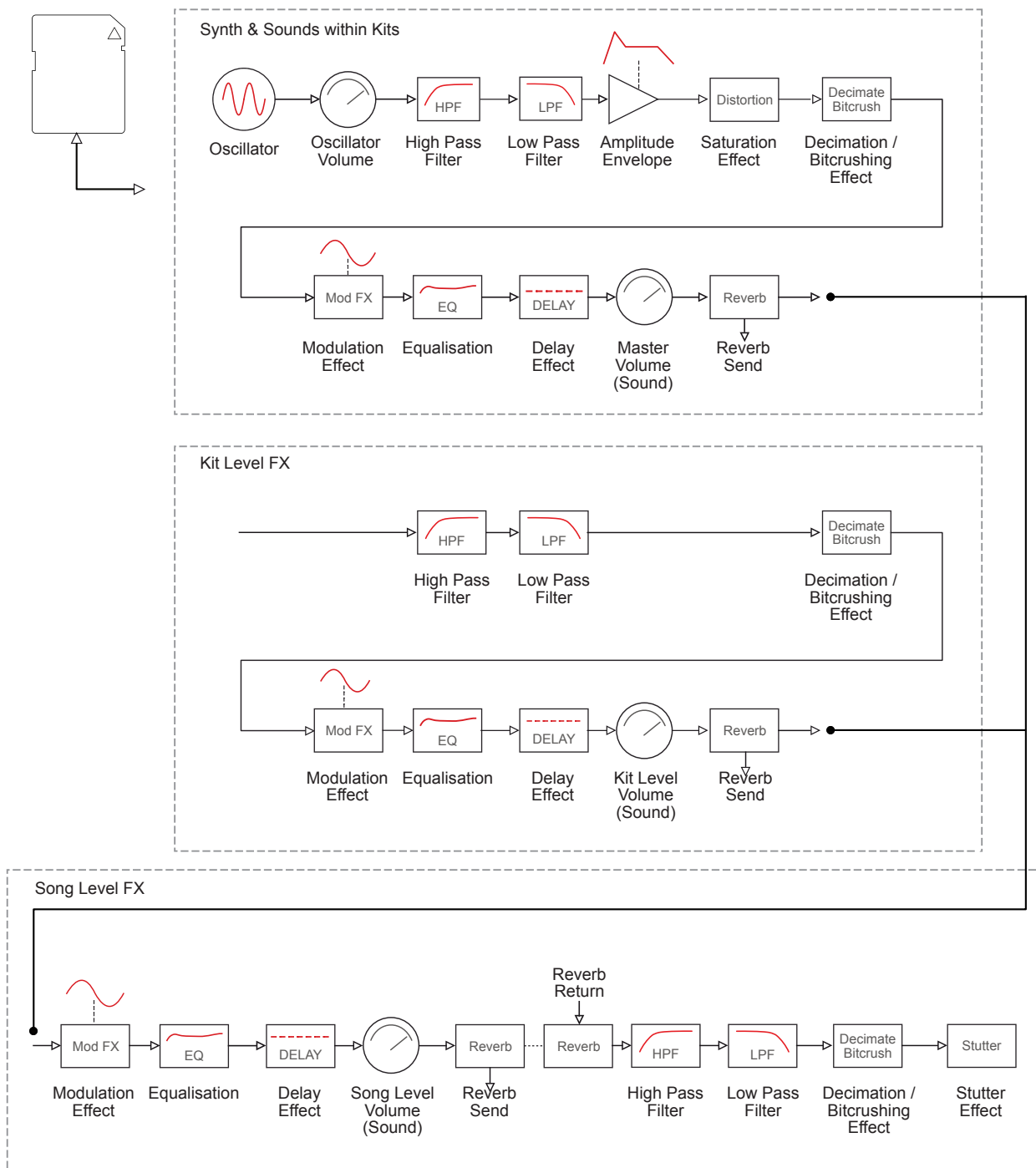

11.2 Effects Overview

Effects exist at both a sound level and also are available at a song level affecting all sounds collectively.

- Instrument effects are the effects that are specific to the sound design, for example the synthesizer engine filters.
- Modulation sources drive changes of other parameters, for example low frequency oscillators (LFO), envelopes and sidechain compressor.
- Modulation (Mod FX) and system effects: These are typically the effects used to change the overall sound or song within Deluge as insert or send effects. These include distortion, delay and reverb. This chapter concentrates on this group of effects which often are common to more than one function. So for example, reverb exists for kits, and for synthesizer engines.

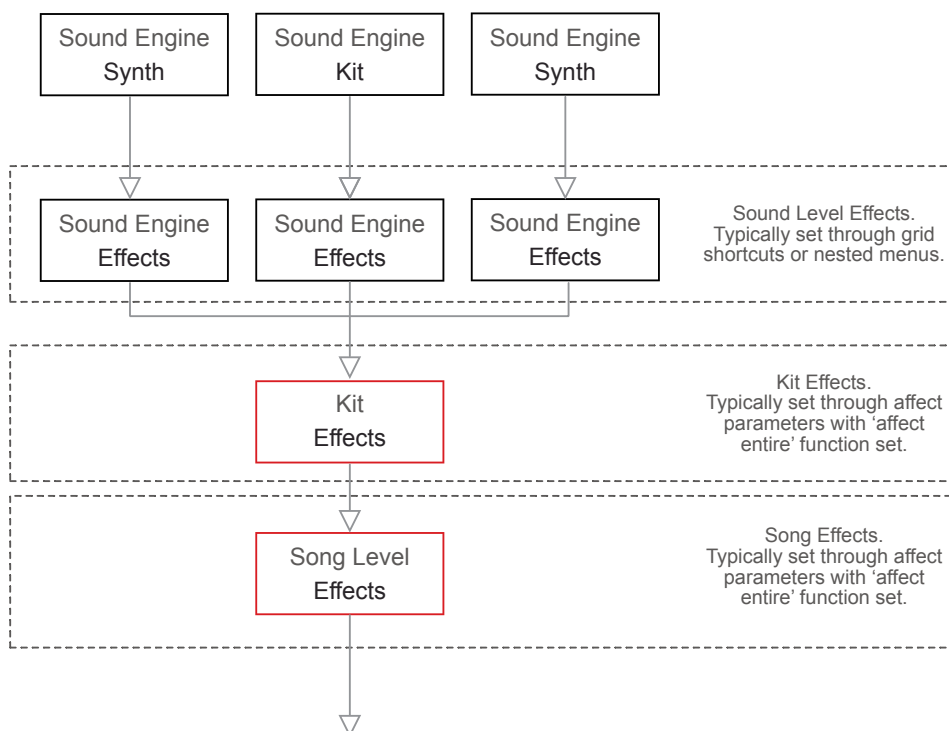

11 Effects

Effects and Parameters

Parameters are available via the grid shortcuts or menu options.

Effect	Quick Button Access	Options & Description
MODULATION FX	TYPE	Type of effect or OFF. Type includes FLANger, CHORus, PHASer.
	RATE	Speed/rate of effect
	FEEDback	Flanger & phaser feedback
	DEPTH	Depth of chorus and phaser
	OFFSet	Chorus offset
EQ	ADJUST (BASS)	Amount of bass at the frequency set
	ADJUST (TREBLE)	Amount of treble at the frequency set
	BFRQ	Frequency setting for bass
	TFRQ	Frequency setting for treble
DELAY	AMOUNT	Delay effect and combined feedback
	RATE	Rate of delay
	STEREO (PinG)	Switches to ping-pong stereo delay (on) & traditional delay (off)
	ANALOG (TYPE)	DIGital or ANALog delay
REVERb	SYNC	Time interval to sync the delay or OFF. Options 4 bar, 2 bar, 1 bar, 2 nd , 4 th , 8 th , 16 th , 32 nd , 64 th
	AMOUNT	Amount of reverb applied
	ROOM SIZE	Room size applied to the whole song
	DAMPENING	Dampening of the reverb effect
	WIDTH	Stereo width setting
	PAN	Enables panning to one side or the other.
		SIDE - sidechain compressor specific to the reverb but from the same side input as the other sidechain compressors. AUTO (default) setting means parameters come from sound with greatest reverb AMOUNT otherwise standard sub-menu options as per the general sidechain.
SATuration	SATURATION	Distortion effect - amount
DECimation	DECIMATION	Decimation distortion effect - amount
CRUSH	BITCRUSH	Distortion bitcrusher - amount
Stutter		Parameter control effect only, no menu options available

11.3 Distortion Effects

Deluge has a distortion effect with three variants which all introduce a gritty aggressive nature to the sound. The three effects are saturation, decimation and bitcrush.

Saturation

Reduces the amplitude of the highest points on a waveform, introducing harmonic content. Saturation is not available at kit level. The only saturation parameter available for adjustment is the amount parameter.

AMOUNT: OFF, 1-15.

Decimation

Reduces the audio's sample rate crudely without filtering, then linearly interpolates it back up to the Deluge's native sample rate. High frequency content is lost, and heavily aliased frequencies are introduced. Decimation is available at sound, kit and song level. The only decimation parameter available for adjustment is the *amount* parameter.

AMOUNT: 0-50.

Bitcrush

Reduces the bit-depth of the audio, introducing sharp corners to the waveform. High frequency content is introduced, and most quiet sounds will become louder. Bitcrush is available at sound, kit and song level. The only bitcrush parameter available for adjustment is the *amount* parameter.

AMOUNT: 0-50.

11 Effects

SETTING SOUND LEVEL DISTORTION EFFECT AMOUNT

1. [CLIP] view, ensure the clip is in-focus.
2. Press [SHIFT] + [DECIMATION] pad, This is also applicable with [BITCRUSH] or [SATURATION] effects.
3. Turn (SELECT) to adjust the amount of distortion. Be careful with volume levels when adding distortion.

or

1. [CLIP] view, ensure the clip is in-focus.
2. Access the effects within the menu. Press (SELECT).
3. Navigate in the menu to the FX section and press (SELECT).
4. Select either 'SATu' - saturation, 'dECi' - decimation, or 'CrUS' - bitcrusher and press (SELECT).
5. Adjust the amount, turn (SELECT) to change the parameter for the selected effect.

SETTING KIT AND SOUND LEVEL DISTORTION EFFECT AMOUNT

1. [CLIP] view, ensure the clip is in-focus.
2. Press [CUSTOM 1/2] button to select the affect parameter. Button lit orange.
3. Turn (UPPER) to change DECIMATION amount or turn (LOWER) to change BITCRUSH amount for the sound selected.
4. Press [AFFECT ENTIRE] to affect the entire kit. Button lit orange.
5. Turn (UPPER) to change DECIMATION amount or turn (LOWER) to change BITCRUSH amount for the entire kit selected.
6. The custom parameters are set in the factory presets by default. These can be assigned or reassigned if required.

11.4 EQ - Equalisation

Equalisation, known as EQ, affects the frequency balance of an audio signal. This can affect the timbre and sound or it can be used as an audio tool for example to reduce a specifically bad frequency. Deluge has a 2-band EQ covering bass and treble frequencies at a fixed Q width.

Frequency Range

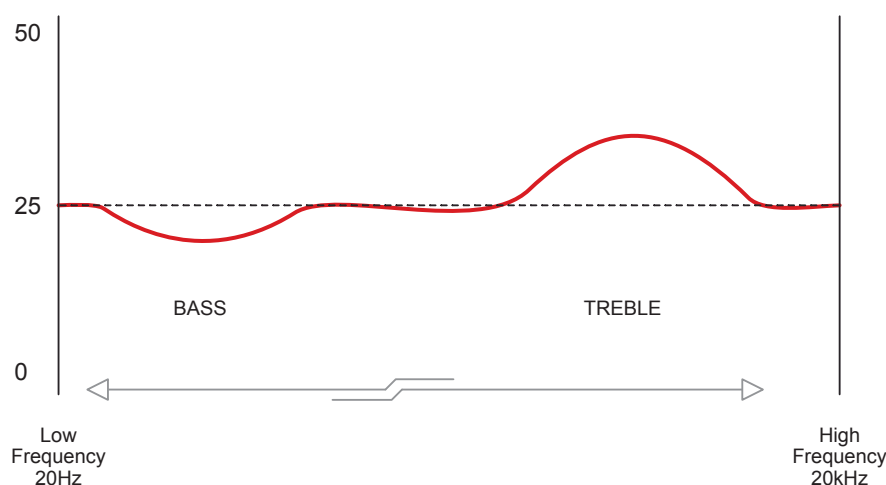

Bass

Low frequency range for adjustments. The bass frequency range is typically in the 0-300Hz region. The frequency position and the amount of boost or cut can be adjusted.

AMOUNT: 0-50. 25 neutral, > 25 to boost, < 25 to cut.
 FREQUENCY: 0-50 Position to boost / cut across the bass range.

Treble

Mid to higher frequency range for adjustments. The treble frequency range is typically in the 2kHz - 16kHz region. The frequency position and the amount of boost or cut can be adjusted.

AMOUNT: 0-50. 25 Neutral, > 25 to boost, < 25 to cut.
 FREQUENCY: 0-50 Position to boost / cut across the treble range.

SETTING EQ AT SOUND LEVEL

1. [CLIP] view, ensure the clip is in-focus, example: a synth.
2. Press [SHIFT] + BASS [ADJUST] pad or [SHIFT] + TREBLE [ADJUST] pad. This selects the EQ band to adjust
3. Turn (SELECT) to adjust the amount of EQ where 25 is central and 25-50 boosts the frequency at the set position and 25-0 attenuates the frequency at the set position.
4. Press [SHIFT] + BASS [FREQUENCY] pad or [SHIFT] + TREBLE [FREQUENCY] pad. This selects the EQ frequency at which to boost or cut.
5. Turn (SELECT) to adjust the frequency between 0-50 representing the treble or bass bands.
6. It is advised to adjust by ear iterating adjustments between step 2 - 5.

or

1. Ensure focus is clip view for a synth or kit.
2. Access the effects within the menu. Press (SELECT).
3. Navigate in the menu to the FX section and press (SELECT).
4. Navigate in the menu to the EQ section and press (SELECT).
5. Select either 'bASS' - bass, 'trEb' - treble to set the amount. Select 'bAFr' - bass , 'trFr' - treble for the frequency of each band.
6. Adjust the amount by turning (SELECT) to change the parameter for the selected effect.

NOTES

SETTING EQ AT KIT LEVEL OR SOUND LEVEL

1. [CLIP] view, ensure the clip is in-focus, example: a kit.
2. Press [CUTOFF / RES] affect button to select filter and - EQ parameters. Button illuminates orange.
3. Press (UPPER) to cycle between LPF, HPF & EQ. Release the control to select EQ.
4. Turn (UPPER) to change TREBLE band amount or turn (LOWER) to change BASS band amount for the sound selected.
5. Press [AFFECT ENTIRE] to affect the entire kit. Button lit orange.
6. Turn (UPPER) to change TREBLE band amount or turn (LOWER) to change BASS band amount for the entire kit selected.

11 Effects

11.5 Delay

NOTES

Delay adopts the standard principle of taking an audio input signal and delaying it at the output. By adding feedback the delay will echo and repeat.

Delay Principles

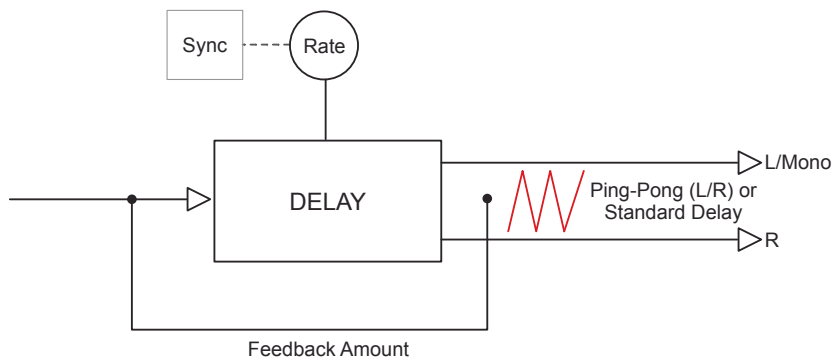

Delay Parameters

Amount

Sets the amount of feedback from the output back into the delay. Amount range 0 - 50.

Rate

Sets the rate at which to sync the delay. Range is 0-50.

Stereo

Sets the output mode to standard delay (off) or to a ping-pong style (on) where the delays are triggered across the stereo field. Ping-pong is disabled if only a single l/mono output is connected and operates only if headphones or stereo l/mono & r connections are connected.

Analog

Sets the style of the delay to give a classic analog style simulation or the digital style sound. Analog is higher in CPU usage and may lower voices.

Sync

The delay can be synchronised to a time interval with respect to the rate. Option to turn synchronisation off, having a free running delay time is available as OFF. Sync options are Off, 4 bar, 2 bar, 1 bar, 2nd, 4th, 8th, 16th, 32nd, 64th.

SETTING DELAY AT SOUND LEVEL

1. [CLIP] view, ensure the clip is in-focus, example: a kit.
2. Press [SHIFT] + DELAY pad, delay shortcuts are as below
 - [AMOUNT]
 - [RATE]
 - [SYNC]
 - [STEREO]
3. For the selected parameter, turn (SELECT) to adjust the value.

or

1. [CLIP] view, ensure the clip is in-focus, example: a kit.
2. Access the effects within the menu. Press (SELECT).
3. Navigate in the menu to the FX section and press (SELECT).
4. Navigate in the menu to the 'dELAY' section and press (SELECT).
5. Select either 'AmoU' - amount, 'rATE' - rate, 'PinG' - stereo, 'tYPE' - analog, 'SynC' - sync. Press (SELECT) for the parameter to select.
6. Adjust the value of the selected parameter by turning (SELECT).

SETTING DELAY AT KIT LEVEL OR SOUND LEVEL

1. [CLIP] view, ensure the clip is in-focus, example: a kit.
2. Press [DELAY TIME / AMOUNT] affect button. Button illuminates orange.
3. Turn (UPPER) to change delay-time RATE value or turn (LOWER) to change delay AMOUNT.
4. To toggle ping-pong or standard, Press (UPPER).
5. To toggle analog or digital, Press (LOWER).
6. Press [AFFECT ENTIRE] to affect the entire kit. Button lit orange. Changes will apply to the entire kit

11 Effects

11.6 Reverb

NOTES

Deluge's reverb applies to the entire song as a send / return effect. Only the amount for each individual part can be adjusted. Reverb emulates the characteristics of a room and its shape. In the real world, audio bounces and ricochets through the room and between walls. Different rooms therefore have different characteristics giving the sense of space and distance.

Reverb Principles

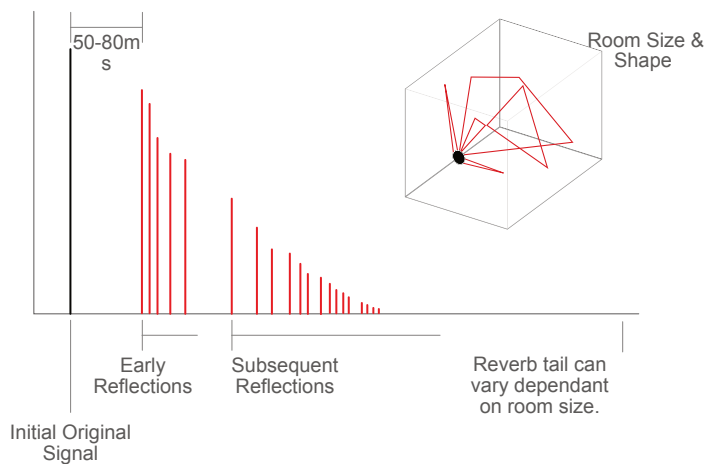

An emitted sound will be heard followed by the initial reflections, for example direct from the walls within approx 100ms. Subsequent reflections typically where sound bounces between walls will follow. The room size and shape will therefore affect the reverberant sound.

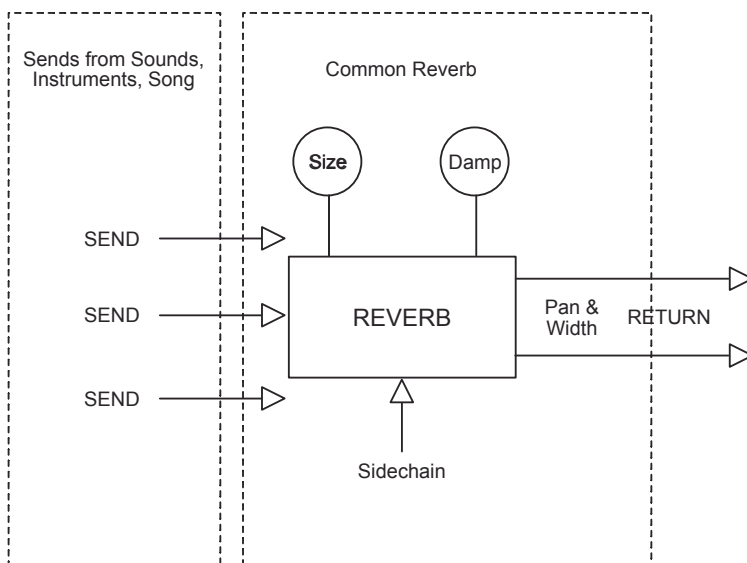

NOTES

Reverb Parameters**Amount**

Sets the amount of signal sent to the reverb. This is specific to each sound, synth, etc while all other parameters are common across sounds, instruments and song. Amount range: 0-50.

Pan

Pans the reverb signal left and right within the stereo-field. Range is 32L-0-32R.

Width

Sets the spread of the reverb giving a wider stereo effect. Range is: 0-50.

Dampening

Emulates the softer elements of a room. For example, a crowd of people, furniture, curtains all absorb rather than reflect sounds. Dampening gives a warmer feel, reducing higher frequencies from the reverb tail.

Size

Sets up the room size emulation. Larger rooms would provide longer delays on the reflections. Range: 0-50.

Side

Sidechain settings for reverb. This is a dedicated sidechain for the reverb output, but still utilises the same source as per the generic sidechain compressor.

11 Effects

NOTES

SETTING UP COMMON REVERB PARAMETERS

1. [CLIP] view, ensure the clip is in-focus, example: a kit.
 2. Press [SHIFT] + REVERB pad, reverb shortcuts are as below
 - [PAN]
 - [WIDTH]
 - [DAMPENING]
 - [ROOM SIZE]
 3. For the selected parameter, turn (SELECT) to adjust the value.
- or
1. Ensure focus is clip view for a synth or kit.
 2. Access the effects within the menu's. Press (SELECT).
 3. Navigate in the menu to the FX section and press (SELECT).
 4. Navigate in the menu to the 'rEVE' section and press (SELECT).
 5. Select either 'dAmP' - dampening, 'widt' - width, 'PAN' - pan, 'SidE' - sidechain. Press (SELECT) for the parameter to select.
 6. Adjust the value of the selected parameter by turning (SELECT).

NOTES

SETTING REVERB SEND AMOUNT

1. [CLIP] view, ensure the clip is in-focus, example: a kit.
2. Press [SHIFT] + REVERB [AMOUNT] pad.
3. For the selected parameter, turn (SELECT) to adjust the send value.

or

1. Ensure focus is clip view for a synth or kit for selected sound.
2. Access the effects within the menu's. Press (SELECT).
3. Navigate in the menu to the FX section and press (SELECT).
4. Navigate in the menu to the 'rEVE' - reverb section and press (SELECT).
5. Select 'AmoU' - amount. Press (SELECT) for the parameter to select.
6. Adjust the value of the send amount by turning (SELECT).

or

1. Ensure in clip view for a kit, synth.
2. Press [SIDECHAIN / REVERB] affect button. Button illuminates orange.
3. Turn (LOWER) to change reverb amount.

SELECTING A REVERB ROOM SIZE PRESET

1. Ensure in clip view for a kit, synth.
2. Press [SIDECHAIN / REVERB] affect button. Button illuminates orange.
3. Press (LOWER) to toggle reverb preset between: 'LArG' - large, 'SmAL' - small, 'mEdi' - medium.

SETTING THE REVERB SIDECCHAIN

1. [CLIP] view, ensure the clip is in-focus, example: a kit.
2. Access the effects within the menu's. Press (SELECT).
3. Navigate in the menu to the FX section and press (SELECT).
4. Navigate in the menu to the 'rEVE' section and press (SELECT).
5. Select 'SidE' - sidechain. Press (SELECT) for the parameter to select.
6. Select 'VoLU' - volume level. Press (SELECT) for the parameter to select.
7. Adjust the level by turning (SELECT).
8. Options are auto, 0-50.
 - AUTO takes its parameters from the sidechain compressor of the sound with the highest reverb.
 - 0-50 Takes parameters from as per the normal sidechain setting.

The reverb sidechain allows sidechain compression to be applied to the reverb trails. Deluge achieves this even with a common reverb, by using the sidechain compression parameters of the sound with the most reverb and applying them to the reverb itself. This is the auto setting and typically results in a pleasing and typical sound. Alternatively, the reverb's sidechain compression settings can be manually overridden in the sound editor if desired.

11.7 Modulation Effects

The Modulation Effects - MOD FX, includes 3 types. A chorus, flanger and a phaser. The Mod FX can also be switched off. Chorus operates similar to a delay which 'layers' one or multiple signals with the delay modulated to give a thicker more lush sound. Flangers are similar to chorus with the resonance creating the unique flanging effect. A phaser sits in between the chorus and flanger in sound characteristics where typically a modulated filter delivers its characteristic sound.

Mod FX Parameters

Type

Sets the modulation effect type between 'Off', 'FLAn' - flanger, 'Chor' - chorus or 'PHAS' - phaser. This setting will also designate which of the other parameters are accessible.

Rate

Rate of modulation: 0-50.

Feedback

Flanger and phaser only. Amount of output fed back to the input: 0-50

Depth

Chorus and phaser only. Amount of pitch modulation.

Offset

Chorus only. Time offset between signal and delay.

11 Effects

NOTES

SETTING MOD FX

1. [CLIP] view, ensure the clip is in-focus, example: a kit.
 2. Press [SHIFT] + MOD FX pad, Mod FX shortcuts are as below
 - [TYPE]
 - [RATE]
 - [OFFSET] chorus only
 - [FEEDBACK] - flanger & phaser only
 - [DEPTH] - chorus & phaser only
 3. For the selected parameter, turn (SELECT) to adjust the value.
- or
1. Ensure focus is clip view for a synth or kit.
 2. Access the effects within the menu's. Press (SELECT).
 3. Navigate in the menu to the FX section and press (SELECT).
 4. Navigate in the menu to the 'modU' - modulation FX section and press (SELECT).
 5. Select either 'tYPE' - type, 'rATE' - rate, 'dEPt' - depth, 'oFFS' - offset, 'FEEd' - feedback. Press (SELECT) for the parameter to select.
 6. Adjust the value of the selected parameter by turning (SELECT)

SETTING A KIT MOD FX WITH AFFECT PARAMETERS

1. Press [KIT] to select. Button lit orange.
2. Press [AFFECT ENTIRE]. Button lit orange.
3. Press [MOD RATE / DEPTH] affect button. Button illuminates orange.
4. Press (UPPER) to toggle between the chorus, flanger or phaser.
5. Press (LOWER) to toggle parameters for the lower control between;
 - DEPTH and OFFSET for chorus.
 - FEEDBACK and DEPTH for phaser.
 - FEEDBACK only for flanger.
6. Turn (UPPER) to adjust the rate. Will adjust LFO1 without 'AFFECT ENTIRE' selected.
7. Turn (LOWER) to adjust the selected parameter. Will adjust vibrato without 'AFFECT ENTIRE' selected.

SETTING A SONG MOD FX WITH AFFECT PARAMETERS

1. Select [SONG] view. Button lit blue.
2. Press [AFFECT ENTIRE]. Button lit orange.
3. Press [MOD RATE / DEPTH] button. Button illuminates orange.
4. Press (UPPER) to toggle between the chorus, flanger or phaser.
5. Press (LOWER) to toggle parameters for the lower control between;
 - DEPTH and OFFSET for chorus.
 - FEEDBACK and DEPTH for phaser.
 - FEEDBACK only for flanger.
6. Turn (UPPER) to adjust the rate. Will adjust LFO1 without 'AFFECT ENTIRE' selected.
7. Turn (LOWER) to adjust the selected parameter. Will adjust vibrato without 'AFFECT ENTIRE' selected.

11 Effects

11.8 Stutter Effect

NOTES

Stutter is a general system effect that is only available for control through the affect parameters and is not available in the nested parameter set nor by the shortcut grid.

SETTING UP STUTTER

1. Select [KIT], or [SYNTH], etc,
2. Press [STUTTER / CUSTOM 1]. Button lit orange.
3. Turn (UPPER) to select the stutter length and speed.
4. Press & turn (UPPER) to adjust a short stutter length and speed while triggering.

USING STUTTER

1. Select [KIT] or [SYNTH], etc...
2. [PLAY] the song.
3. Press [STUTTER / CUSTOM 1]. Button lit orange.
4. Press (UPPER) to trigger the stutter effect.
5. Release (UPPER) to stop the stutter effect.
6. Press & turn (UPPER) to adjust a short stutter length and speed while triggering.

11.9 Effects in Song View

Affect parameters are used for effect adjustments in song view. When selecting song [SONG] view it first appears that the affect parameters are not available. However they are accessible by pressing and holding [PAD] in SONG mode.

ACCESSING EFFECTS IN SONG MODE

1. Press [SONG]. Button illuminates solid blue.
2. Press & hold [PAD], where pad is any pad row with an active clip. This enables access to changing the parameters for the CLIP.
3. Press [AFFECT ENTIRE]. Button illuminates orange.
4. The affect parameters are now accessible for the entire SONG. The associated buttons and UPPER / LOWER controls can be adjusted.
5. Parameters available by default in song view are:
 - Mod FX
 - EQ
 - Delay
 - Reverb
 - Stutter
 - Bitcrush / decimation (custom 2 & 3)

— MIDI —

12 MIDI

12.1 MIDI Connections

NOTES

MIDI is a standard music protocol used to connect multiple devices in order to communicate and was first introduced in the early 1980's. Deluge uses the most common 5 Pin DIN connection as well as a USB connection.



Deluge has both a MIDI in and Out 5-pin DIN connection.



USB MIDI is also available via the Type-B USB connection.

MIDI DIN synchronises on PPQN pulses per quarter note. 24 and 48 pulses per quarter note (PPQN) are most common. This can be adjusted in the settings, trigger menu in Deluge and by default is set to 24.

Deluge uses MIDI CC (control change) messages while also providing *program change* and *bank change* options. This allows the presets and patches of other synths and gear to be changed and controlled as well as adjusting parameters remotely.

USB Host

When Deluge is powered up (external supply, not internal battery) it can be connected via the USB connection to other devices as a USB host. The USB MIDI device must be connected on starting / booting Deluge up. The connection can be disconnected / reconnected once it's booted in this set-up.

Deluge supports one USB MIDI 'hub' devices as a host. Powered USB Hubs are also useful in powering up Deluge as well as other connected USB devices. Deluge will blink "MIDI" for a working MIDI device, or "UNKNOWN" for anything else. Multiple hubs especially more than four connected may not operate correctly and "FULL" is displayed if more than four devices are connected. Deluge will blink "HUB" when a connected hub device is detected and working and "DETACH" when a device is detached. If your device doesn't work and you get no error message, it may be a power issue.

Hosted MIDI USB devices are supported for both MIDI input and output.

Differentiating MIDI Input devices

MIDI devices have 16 available MIDI channels all of which can be used to communicate with Deluge by USB or the MIDI DIN port. Multiple devices can also be connected to Deluge with the use of a USB hub and also through the MIDI port which would mean more than 16 channels are present simultaneously in the network, providing input to Deluge. These channels can be set to control different functions, for example synths. Deluge can be set to differentiate between the incoming MIDI from different devices. These need to have been 'learned' in Deluge to assign the input controls to the correct function.

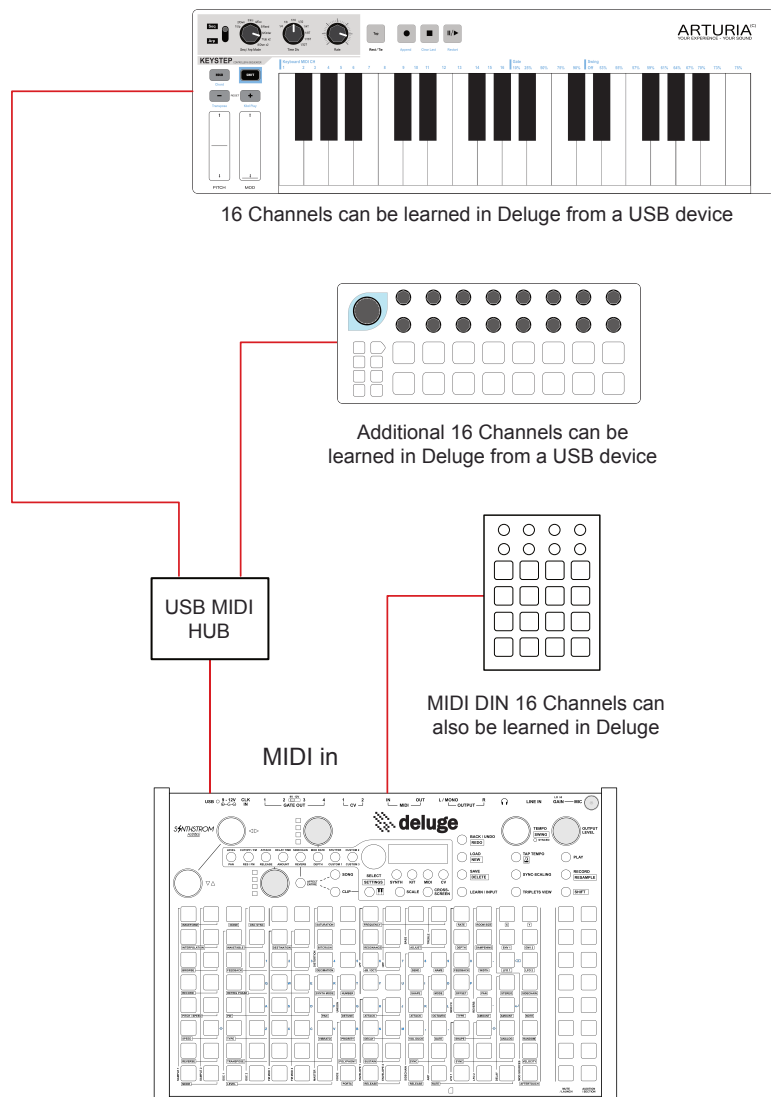

SETTING MIDI DIFFERENTIATION ON

1. Press [SHIFT] + press (SELECT) to access the configuration menu.
2. Turn (SELECT) and scroll to 'midi' - MIDI. Press (SELECT).
3. Turn (SELECT) and scroll to 'diFF' - differentiation. This enables Deluge to differentiate from different connected devices across multiple channels.
4. Press (SELECT) and then turn (SELECT) to set to ON. This allows multiple devices to be differentiated in Deluge.
5. Press (SELECT) and then turn (SELECT) to set to OFF. This turns differentiation off to revert to the more traditional setup.

MIDI Differentiation operates for standard MIDI and also MPE MIDI. It is advised to have differentiation on when using MPE devices.

12.2 MIDI Hardware Configuration

MIDI configuration requires the match up of both Deluge along with the external device. It is important to check out the manufacturers instructions when connecting other devices.

Typical MIDI Set Up

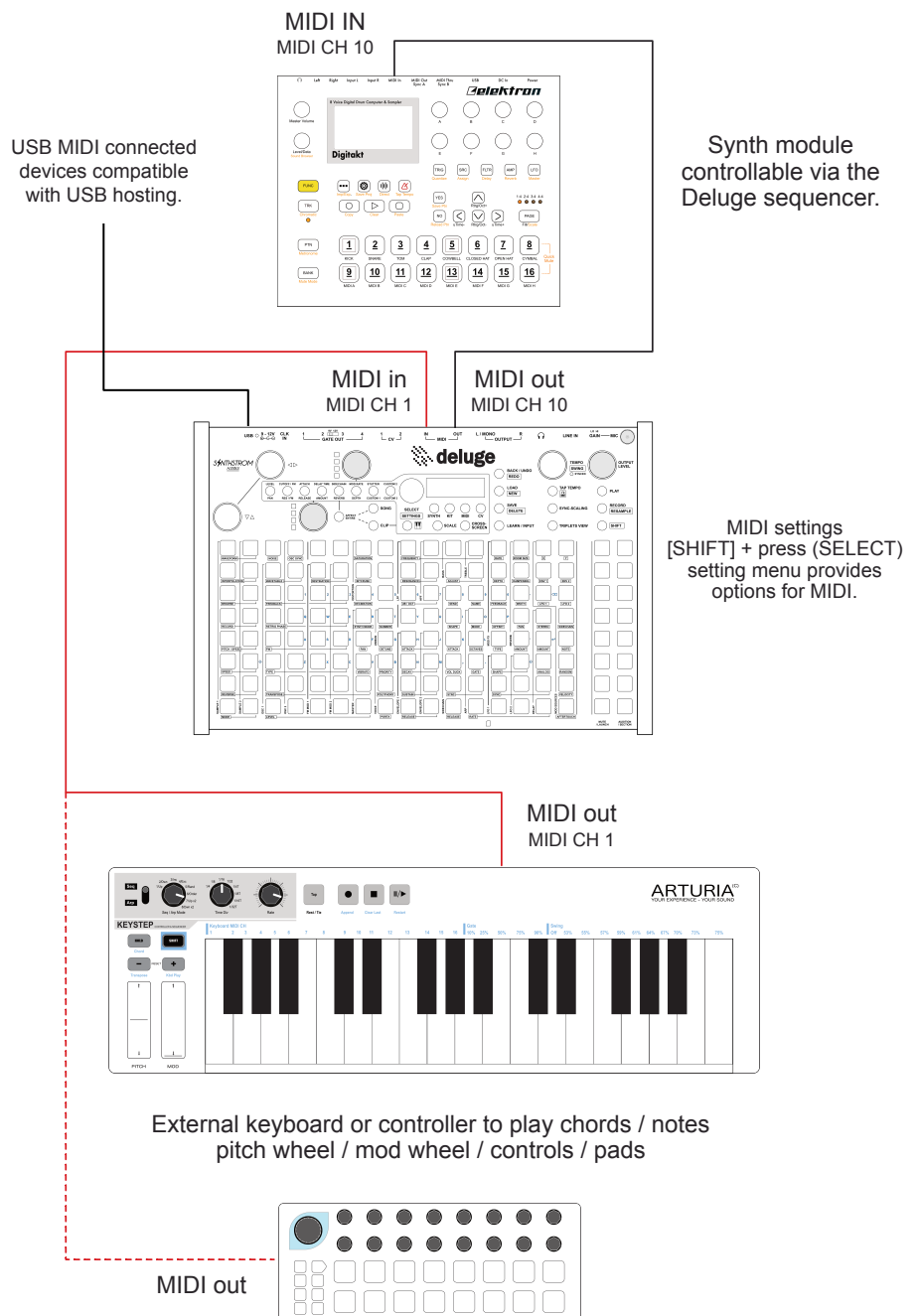

12 MIDI

NOTES

MIDI Settings

[SHIFT] + press (SELECT)

Function	Sub Category	Setting Options
TCLO Trigger Clock	INput	PPQN - sync pulses. Pulses per quarter note. 24 default. AUTO start on/off. Whether the presence of a trigger clock signal should start or stop playback automatically.
	OUTput	PPQN - sync pulses. Pulses per quarter note. 24 default.
MIDI MIDI Settings	CLOCK	IN - MIDI beat clock input ON or OFF.
		OUT - MIDI beat clock output ON or OFF.
		MAGN - tempo magnitude matching ON or OFF.
	THRU	MIDI thru, ON or OFF.
	CMD Global MIDI Command	PLAY
		REStart - restart playback if already playing.
		RECOrd
TAP tempo		
UNDO		
dEVI	REDO	
	LOOP	
	LAYER - same as loop but with overdubs.	
diFF	Sets MIDI differentiation ON or OFF.	
		MIDI Device setting options are available depending on the connected USB and MIDI devices e.g. din, computer etc:- - MPE. Sets MPE Zone configuration. - VElO. Default velocity sensitivity per MIDI device.

MIDI Implementation Chart

Message	Type	Transmitted	Recognised
Velocity	Note on	Yes	Yes
	Note off	No	No
Aftertouch / Pressure	Polyphonic	No	Yes
	Channel	Yes	Yes
Pitch bend		Yes	Yes
CC & general		Yes Numbers assigned by user	Yes Parameter must be 'learned' by user
Bank select	CC 0	Yes	No
	CC 32 (LSB)	Yes	No
PGM change		Yes	No
Channel mode	All sound off	No	No
	Reset all controller	No	No
	Local control	No	No
	All notes off	No	Yes
System common	System exclusive	No	No
	MIDI time code quarter frame	No	No
	Song position pointer	Yes	Yes
	Song select	No	No
	Tune request	No	No
System real time	Clock	Yes*	Yes
	Start	Yes*	Yes
	Continue	Yes*	Yes
	Stop	Yes*	Yes
	Active sensing	No	No
	Reset	No	No

*Only if MIDI Clock output is enabled

Settings for MIDI are contained in the general setting menu, accessed by pressing both [SHIFT] + (SELECT). External gear should be connected via MIDI or where a DAW or compatible software / hardware connection exists then USB is also possible.

■ FOLLOWER: MIDI SYNCHRONISATION FROM EXTERNAL GEAR

1. Press [SHIFT] + press (SELECT) to access the configuration menu.
2. Turn (SELECT) and scroll to 'midi' - MIDI. Press (SELECT).
3. Turn (SELECT) and scroll to 'CLOCK' - clock. This enables setting the clock sync to external gear where Deluge acts as leader or follower. Press (SELECT) to step into clock menu.
4. Turn (SELECT) to highlight 'in' - MIDI beat clock-in, in the clock menu.
5. Press (SELECT) and turn (SELECT) to set 'In' to ON. OFF ignores external commands. Trigger clock may also affect this function.
6. As a follower, tempo is governed by the external lead device and cannot be changed on Deluge when playing. Control commands such as play and stop will be triggered by the external device but can be triggered from Deluge when the external controls are not triggered. 'Synced' LED will indicate sync status.

■ LEADER: MIDI SYNCHRONISATION TO EXTERNAL GEAR

1. Press [SHIFT] + press (SELECT) to access the configuration menu.
2. Turn (SELECT) and scroll to 'midi' - MIDI. Press (SELECT).
3. Turn (SELECT) and scroll to 'CLOCK' - clock. This enables setting the clock sync to external gear where Deluge acts as leader or follower. Press (SELECT) to step into clock menu .
4. Turn (SELECT) to highlighting 'oUt' - MIDI beat clock output.
5. Press (SELECT) and turn (SELECT) to set 'oUt' to ON. OFF to disable sending commands.
6. Playing as a follower takes precedence. Beat clock outputs will be sent out only when set up with beat clock outputs on and when not playing as a follower. Setting THRU mode may satisfy situations where external signals are passed through Deluge to the MIDI output.

SETTING UP MIDI THRU

1. Press [SHIFT] + press (SELECT) to access the configuration menu.
2. Turn (SELECT) and scroll to 'midi' - MIDI. Press (SELECT).
3. Turn (SELECT) and scroll to 'tHrU' - THRU. This enables sending the incoming MIDI also straight to the MIDI output. Press (SELECT).
4. Turn (SELECT) to set 'tHrU' to ON. Set to OFF to prevent incoming MIDI to be transferred to the MIDI out.

NUDGING MIDI SYNC ADJUSTMENTS

1. Press (SCROLL ◀▶) + turn (TEMPO).
2. Each Tempo control 'click' will adjust by one MIDI clock message / one 96th note.
 - Deluge as follower: nudge Deluge's MIDI clock .
 - Deluge as leader: nudge MIDI beat clock output to align external device.
3. The display will indicate 'nUdG' - nudge, when making the adjustments.

12 MIDI

12.3 MIDI In

NOTES

The Deluge can be controlled by external MIDI keyboards, controllers or pads by mapping incoming MIDI to the desired notes, pads or parameters. Velocity is recorded with MIDI inputs.

SETTING UP AN EXTERNAL KEYBOARD OR PADS

1. Connect the keyboard MIDI-out to the MIDI-in connection of Deluge. Power both devices on.
2. Press [SYNTH], [KIT], [CV] or [MIDI] to select the instrument clip. Button selected illuminates red.
3. Press & hold [LEARN / INPUT] + [AUDITION] pad of a note / pad to map.
4. While holding [LEARN / INPUT] & [AUDITION] pad, press a keyboard note on the external keyboard or the pad on the external controller.
5. The audition pads will blink and turn pink or a brighter colour when a mapping input is set.
6. The MIDI channel plus the external keyboard notes will now be mapped to the Deluge. Pitch bend and mod wheel on the external midi controller keyboard will also function.
7. To unmap the keyboard press & hold [LEARN / INPUT] + [AUDITION] any pad.

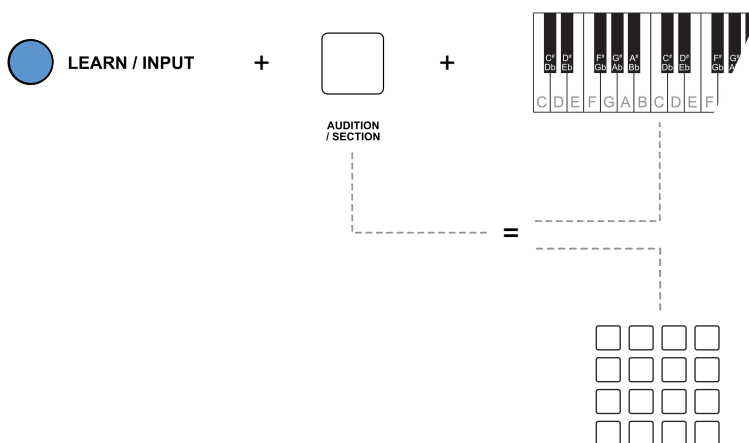

Keyboard is mapped across the notes. For pads ensure the exact pad is assigned to the audition pad required. MIDI foot switches can also be mapped into Deluge.

SETTING UP AN EXTERNAL CONTROLLER

1. Connect the controller MIDI-out to the MIDI-in connection of Deluge. Power both devices on.
2. Press [SYNTH], [KIT], [CV] or [MIDI] to select the instrument clip. Button selected illuminates red.
3. Select the parameter to map to. Press [SHIFT] + [PAD], where pad is the parameter to map. Example LPF frequency.
4. The pad will flash white indicating it is selected and the display reflects this parameter.
5. Press & hold [LEARN / INPUT]. Parameters that can't be mapped will display 'Cant'
6. While holding [LEARN / INPUT], adjust the control on the external device to map to the selected parameter.
7. Display will indicate mapping learn is complete by displaying 'LEAR'.
8. The MIDI channel plus the external control will now be mapped to the Deluge.
9. To unmap the keyboard press & hold [SHIFT] + [LEARN / INPUT] while the parameter is selected, indicated by its flashing pad.

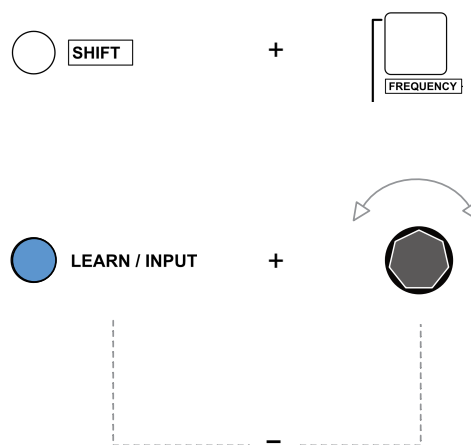

RECORDING AUTOMATION USING AN EXTERNAL CONTROLLER

1. Set up an external MIDI controller, whether a keyboard or pad or rotary / slider controls and map the incoming MIDI to the parameters desired.
2. Press [RECORD] to arm recording.
3. Press [PLAY] to start recording.
4. Any incoming MIDI that is relevant to the clip being recorded will be recorded in including automation of parameters and velocity. Example, changing a control mapped to frequency cutoff will record in as automation. Assignment of gold affect controls is irrelevant.
5. Parameters containing automation will display their name with a full stop / period / dot next to them when assigning a parameter knob's MIDI parameter. This indicates automation is present.
6. Press [PLAY] to stop.
7. To delete MIDI in recorded automation, re-start recording and press [SHIFT] and adjust the mapped external controller.
8. Parameters containing automation will display their name with a dot next to them when assigning a parameter knob's MIDI parameter - so it will be easy to see where automation exists.
9. Assigning a new MIDI parameter to a parameter knob does not move the knob's automation over to the new MIDI parameter. Automation can be manually copied and pasted using the normal manual process.

Any recorded data for pitch bend and aftertouch (channel pressure) MIDI inputs is captured in MIDI, Synth or CV clips and is retained with the clip even when changing presents or clip types. Also note-off velocity, if delivered by an external controller will be recorded.

12.4 Global MIDI Commands

The Deluge can be controlled at a system level for example *play* and *stop*, using external MIDI commands. Any external controller can be used including a keyboard, pads or a foot controller switch.

There are a number of global commands that are already available within the MIDI section of the settings menu under the CMD - command function.

These are:-

- 'PLAY' - play & stop playback. Same as pressing the [PLAY] button.
- 'REST' - restart playback. If already playing will restart from the beginning. Same as pressing the (SCROLL ◀▶) + [PLAY] buttons.
- 'REC' - record. Same as pressing [RECORD] button.
- 'TAP' - tap tempo. Will count and set tempo based on taps. Equivalent to tapping [TAP TEMPO] button.
- 'UNDO' - backup the last command's. This is the same as pressing the [BACK / UNDO] button.
- 'REDO' - restate the last command's. This is the same as pressing the [SHIFT] + [REDO] buttons.
- 'LOOP' - loop. Will record as a loop. Essentially this will automatically step through the process; 1. Start playback. 2. Begin recording on any clip(s). 3. Finish recording of clip.
- 'LAYE' - layer. Same as loop but overdubs as continuous layers.

Notes on other MIDI command use.

The common functions when using external MIDI is to control notes and parameters. Also the global commands can be controlled externally for overall control of deluge and when working with loops.. Other MIDI control functions are also available, for example, Song specific functions:-

- Launching of clips or sections.
- Muting / unmuting clip rows on song mode.
- Playing one sound in a kit clip.
- Playing a synth belonging to a clip.

12 MIDI

SETTING UP AN EXTERNAL MIDI FOOT SWITCH CONTROLLER

1. Connect the foot switch to the MIDI-in connection of Deluge.
2. Global commands are ideal for controlling with an external foot controller.
3. Press [SHIFT] + press (SELECT) to open the settings menu.
4. Navigate to MIDI settings, turn (SELECT) and select 'CMD' in-focus.
5. With 'CMD' in-focus, press (SELECT) to open the global MIDI command menu options.
6. Choose the option to map to the external switch: example; switch 1 = play / stop, switch 2 = record, switch 3 = undo, switch 4 = redo.
7. With the option in-focus press (SELECT) and the [LEARN / INPUT] button will blink indicating it is available for mapping. 'nOnE' - NONE displays if no MIDI note or channel is currently assigned.
8. Press & hold [LEARN / INPUT] and press the associated switch on the external MIDI foot controller.
9. The display will indicate 'SET' - SET to show the setup is now complete and the switch is mapped to the function.
10. To unmap the command turn (SELECT) when the function setting is in-focus or set it to a new input.

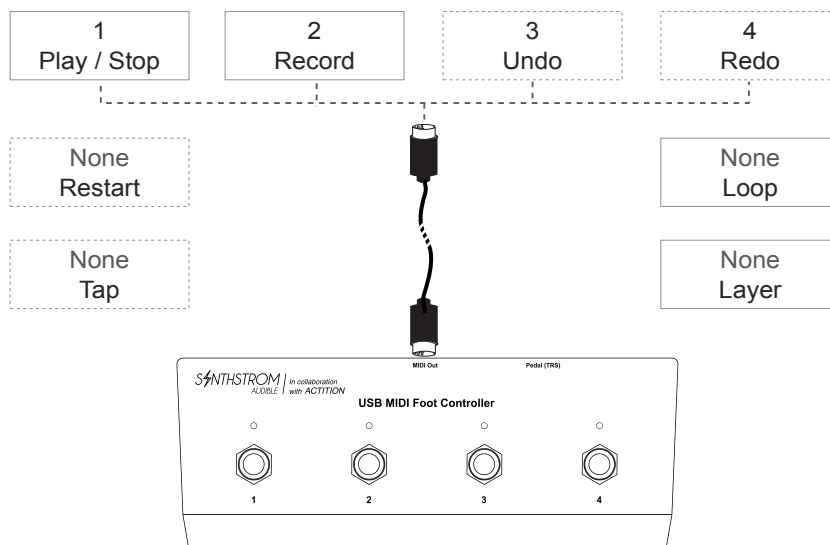

12.5 Tempo Magnitude Matching

When playing as a follower via MIDI beat clock (but not via trigger clock), if the incoming clock is around half or around double the tempo that the song was previously set to, then the Deluge will accordingly multiply or divide the tempo of the incoming clock so that the tempo at which the song on the Deluge plays is as close as possible to the tempo that it was set to.

This is useful in a couple of scenarios:

- Perhaps the user isn't concerned with the labelling of time divisions (8th-notes, 16th-notes, etc.) and nonetheless wants to sync the Deluge as a follower without worrying about whether their song will play at the intended tempo rather than twice / half as fast.
- Some loop pedals (although not common) have the ability to act as a syncing leader by outputting a MIDI beat clock whose exact tempo is determined on the fly according to the length of the loop that the user creates. The user may wish, for example, to record a guitar loop with their loop pedal (with no kind of metronome or anything determining the tempo in advance), and then have the Deluge play a drum beat along to it, perfectly in sync. With a compatible loop pedal, this works. However, the loop pedal would not necessarily know the difference, say, between a loop that the user intended to be at 160bpm, and one intended to be at 80bpm (160 being double 80), and may pick the wrong option. The Deluge, knowing what tempo to approximately expect, can automatically correct the incoming MIDI beat clock if it is around double or half the tempo expected, making it a certainty that the Deluge will begin playback at somewhere near the expected tempo.

SETTING TEMPO MAGNITUDE MATCHING

1. Press [SHIFT] + press (SELECT) to access the configuration menu.
2. Turn (SELECT) and scroll to 'midi' - MIDI. Press (SELECT).
3. Turn (SELECT) and scroll to 'CLOCK' - clock. Press (SELECT) to step into clock menu.
4. Turn (SELECT) to highlight 'mAGn' - MIDI beat clock input, from within the clock menu.
5. Press (SELECT) and turn (SELECT) to set 'mAGn' to ON or OFF.
 - ON - multiplies or divides incoming clock tempo if it is a figure close to double or half the current song tempo.
 - OFF - incoming tempo is applied unaffected.

MANUALLY SETTING TEMPO MAGNITUDE AS FOLLOWER / LEADER

If errors (too fast / too slow) occur after automatically matching the tempo or when controlling a follower device and its tempo is double / half, manual adjustments can be made. Adjustments to the relative speed can be applied.

1. Press & hold [LEARN / INPUT] + turn (TEMPO).
2. When Deluge is the leader, the display will show the tempo double / half while making manual changes.

12.6 Sync-scaling

For users syncing the Deluge as a follower and wanting to make use of unusual time signatures, sync-scaling is a fun and creative feature. A clip of an unusual time signature may be created by setting its length to an unusual number of beats, example; seven 8th-notes. Using sync-scaling, the Deluge, when synced as a follower, can make those seven 8th notes take up the same amount of time that the incoming MIDI beat clock says that eight 8th-notes are meant to take up.

There are a couple of applications for this:

- The user may wish to create polyrhythms by e.g. having an external device (the syncing leader) playing a sequence in 4:4 timing, while the Deluge (the follower) squeezes 7 notes into a bar instead of 8.
- Some loop pedals may act as a syncing leader. However, they are likely to assume that any loop created (e.g. with a guitar) is in 4:4 timing. If the user had in fact played a guitar loop in 7:8 timing, the loop pedal would still be outputting a 4:4 MIDI beat clock - dividing the entire loop into, say, fours rather than sevens. The solution is to tell the Deluge to scale the incoming 4:4 MIDI beat clock into a 7:8 one, so that a 7:8 sequence created on the Deluge would play perfectly synced to the 7:8 guitar loop, despite the incorrect 4:4 MIDI beat clock passing between the two devices.

Sync-scaling is tied to the length of one clip in a song, and tells the Deluge that that clip's length should be squeezed into 1 bar of incoming MIDI beat clock (or 2 bars, or 4 or 8 bars, depending on how long the clip is; the Deluge will use whatever magnitude of sync-scaling causes the smallest change in tempo).

Even while the Deluge is playing synced as a follower, sync-scaling may be switched on or off, and the sync-scaling clip may have its length changed. Despite any such changes, the Deluge will keep the sync-scaling clip playing in time to the syncing leader. It will also attempt to keep all other clips in time; this works best if the other clips are of the same time signature as the sync-scaling clip (that is, their lengths are the same, or half our double, or 4 times shorter or longer, etc.)

USING SYNC SCALING

1. [CLIP] to enter clip view on the selected clip where sync scaling will be applied.
2. Set its length to the beats required. This is typically an unusual length to get the best effect from sync-scaling and to fit it into the incoming sync timings.
3. Press [SYNC-SCALING] to set clip for sync scaling. Button will flash blue.
4. Leaving the clip in this mode the sync-scaling button will remain statically illuminated - not flashing. This indicates that sync-scaling is active but not on the selected clip.
5. Press [SYNC-SCALING] to switch it off. Button will be unlit.

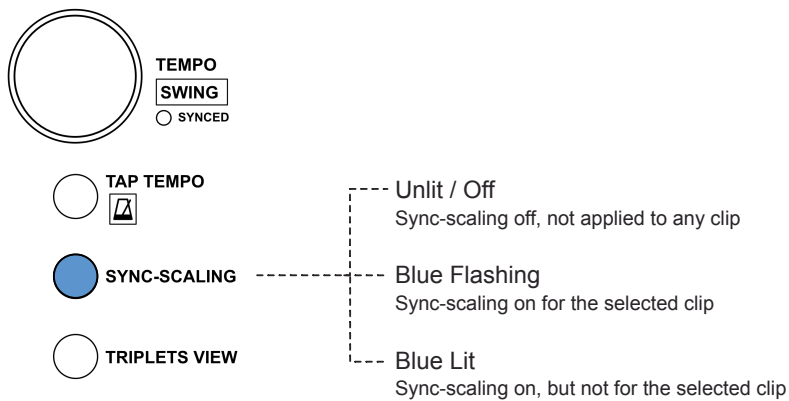

12.7 MIDI Out Settings

Deluge can be a controller for external MIDI devices for example sound modules and synthesizers. MIDI clips are configured in similar way to creating synth clips. MIDI clips even have an arpeggiator. Instead of the notes triggering the synth engine, the notes will trigger the external MIDI channel.

MIDI SETTINGS IN SOUND EDITOR

1. Select [CLIP] view.
2. Press [MIDI] on Deluge. Button illuminates red.
3. The display will indicate the existing MIDI channel.
4. Press (SELECT) to access the MIDI sound editor menu.
5. Turn (SELECT) to access the functions in the MIDI configuration through the sound editor.
6. Press (SELECT) to choose each function and select its parameters.
7. Turn (SELECT) to change settings.

Function	Sub Category Parameter	Quick Button Access	Options & Description
PGM Program	N/A	N/A	None, 1-128. Program change message.
BANK Select	N/A	N/A	None, 1-128 CC0 Bank select message.
SUB Bank	N/A	N/A	None, 1-128 CC32 - LSB Sub bank message.
	MODE	MODE	Option to set the arp to OFF, UP, DOWN, BOTH or RANDom.
	SYNC	SYNC	Time interval to sync the arp or OFF. Options 4 bar, 2 bar, 1 bar, 2 nd , 4 th , 8 th , 16 th , 32 nd , 64 th
ARPE Arpeggiator	OCTAVES	OCTAVES	Number of octave range of arpeggiator.1-8.
	GATE	GATE	Amount in % of the available time division which each arp note fills.
	RATE	RATE	Rate / speed of arpeggiator.

Some synths and devices may use the bank or sub bank to change the bank, They also may be set for NRPN instead of CC messages. It is always advised to check the documentation of any device to which Deluge will be connected and ensure matched compatibility in the MIDI communications protocol settings. The MIDI implementation data for the connected device is usually found in manufacturers documentation and in particular is a good place to start as a reference.

12 MIDI

12.8 MIDI Out Controls

NOTES

SETTING UP AN EXTERNAL MIDI CHANNEL

1. Connect an external device and ensure MIDI channels and setting are configured correctly.
2. Press [CLIP] to select clip view.
3. Press [MIDI] on Deluge. Button illuminates red.
4. The display will indicate the existing MIDI channel set for MIDI output.
5. Turn (SELECT) to change the channel to match the external device. Range is 1-16 channels.
6. The [AUDITION] pads should trigger the external synth when played manually.

CREATING A BASIC MIDI CLIP

1. Press [CLIP] to select clip view.
2. Press [MIDI], Button illuminates red.
3. The display will indicate the existing MIDI channel set for MIDI output or a suffix on the channel number. *
4. Program a pattern using the grid by pressing the [PAD]'s. Rows represent the note pitch while columns represent the note timing. The same features as programming a synth exist in navigating and editing on the grid for MIDI clips.
5. Press [PLAY] to play the pattern which in turn will trigger the connected device on the same MIDI channel.

* If you wish to have more than one clip outputting on the same MIDI channel simultaneously, additional clips will be set to the same MIDI channel but will contain a suffix after their channel number, e.g. "2A", "2B", and so on. This is to allow them to be treated as unique "instruments", in terms of which ones may play simultaneously, while still outputting on the same channel.

MAPPING DELUGE TO CONTROL EXTERNAL PARAMETERS

1. Select [CLIP] view.
2. Press [MIDI] on Deluge. Button illuminates red.
3. Ensure the destination device is set correctly to receive MIDI (channels, CC mapping etc).
4. Press affect parameter button to choose one of the 8 available parameter slots per control. Example, [LEVEL / PAN]. In total 16 parameters (8 upper, 8 lower) can be set for MIDI controls.
5. Press (UPPER) or (LOWER) to see the assigned MIDI CC message to each. 'nonE' - NONE indicates no assignment otherwise the CC number will be displayed.
6. Press & hold (UPPER) + turn (SELECT). Assign a CC number that matches the destination device CC for the parameter to control. Example, CC102 filter frequency on the external synth.
7. CC messages range from CC0 - CC119, bend and aftertouch. CC1 is typically mod wheel.
8. Turning (UPPER) will control the external parameter. Example filter frequency, with a range of 0-127 on Deluge as min and max values.
9. Repeat step 4 - 8 for the (LOWER) control.

RECORDING AUTOMATION FOR EXTERNAL PARAMETERS

1. Select [CLIP] view.
2. Press [MIDI] on Deluge. Button illuminates red.
3. Ensure the destination device is set correctly to receive MIDI (channels, CC mapping etc).
4. Map the UPPER & LOWER gold controls to the desired MIDI parameters on the external device.
5. Press [RECORD] to arm recording. Button illuminates red.
6. Press [PLAY] to start the sequencer and recording.
7. Turn (UPPER) or (LOWER) control as desired to record the MIDI CC changes into the pattern.
8. The MIDI CC number shown when pressing (UPPER) or (LOWER) will be tagged with a full stop / period / dot to indicate that it is automated.

DELETING AUTOMATION FOR AN EXTERNAL PARAMETERS

1. Select [CLIP] view.
2. Press [MIDI] on Deluge. Button illuminates red.
3. Press [SHIFT] + press (UPPER) or (LOWER) to delete the automation associated with the parameter selected by the button and the control pressed.
4. Automation will be cleared and the MIDI CC number shown when pressing (UPPER) or (LOWER) will no longer be tagged with a full stop / period / dot indicating no automation present.

12.9 MIDI Out within Kits & Songs

As well as samples, sounds, synths, MIDI can also be combined within a kit as a row providing a note or control output to a MIDI channel. MIDI sequencing can then take place alongside other kit sounds. Song specific MIDI commands are saved with the song. Global settings remain unchanged.

CREATING / CONVERTING TO MIDI WITHIN KIT CLIPS

1. Select [CLIP] view and select a [KIT].
2. Press & hold [AUDITION] pad for the row which will convert to MIDI + press [MIDI].
3. Hold [AUDITION] pad for the MIDI row to display the channel and note information, each separated by a dot.

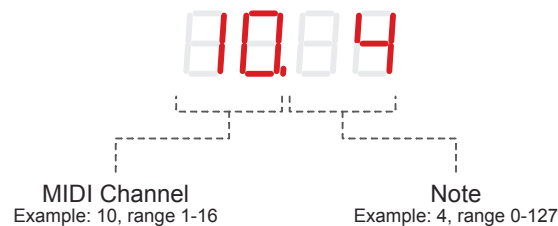

4. While holding the audition pad, turn (LOWER) control to change the MIDI channel.
5. While holding the audition pad, turn (UPPER) control to change the note value.
6. [KIT] + [SAVE] to save the kit and retain the MIDI setting in the kit.

CHANGING CLIP MIDI CHANNEL WITHIN SONG VIEW

1. Select [SONG] view.
2. Press & hold [PAD] for the MIDI clip row to change + turn (SELECT) to change channel 1-16.
3. MIDI button will flash while holding and display will show the current channel.

12 MIDI

12.10 Overview of MIDI MPE and Polyphonic Aftertouch

MIDI Polyphonic expression or MPE as its often called, is an enhanced part of the official MIDI standard and refers to the ability to control note in more expressive manner than the standard MIDI messages. Until the introduction of MPE, polyphonic aftertouch was the only MIDI message considered to have independent expressive control. This is still supported even with MPE.

In traditional MIDI a note message would be sent on the MIDI channel, along with any other note. In addition any controls such as pitch bend would also be applied on the same channel, meaning the pitch would affect all notes on the same channel.

With MPE a series of channels are set up, known as zones, to communicate not only multiple notes but also MIDI information for each individual note. For example a pitch changes could be applied to only one note in a chord.

The two zones that cluster the channels are defined in the official MIDI protocol as lower zone (most common default) and the upper zone. Each zone has a master channel which communicates all messages. The master channels are fixed as 1 for lower and at 16 for upper zones. Any subsequent member channels in the zone increment up or down from the master channel in consecutive order. Generally these can be set by a device MPE Configuration message, where the host device sends the MPE setup automatically at power on or start up. However not all devices adhere to this exact standard and manual configuration is usually possible for the devices.

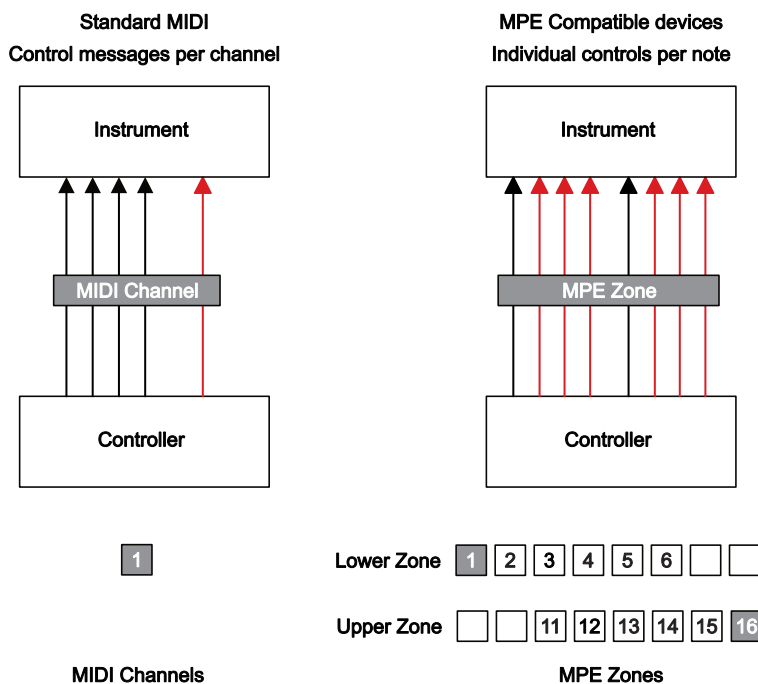

12.11 MPE Application for MIDI Input in Deluge

MIDI MPE is all about better control of expression which is applied through three dimensions which are typically recognised from how a note is played on a MPE compatible MIDI controller.

For the synthesizer engines.

- Dimension 'X' is typically horizontal movement across a note key. This is by default patched to pitch bend in Deluge. In addition to the hard coded patching, the 'X' dimension can be patched elsewhere using the Deluge 'X' parameter. Setting the pitch bend range to zero will negate the hard coded patching if required.
- Dimension 'Y' is typically vertical movement up and down a notes key. This may be patched within existing synths, for example to LPF cutoff frequency. The 'Y' dimension can be patched elsewhere using the Deluge 'X' parameter.
- Aftertouch is the pressure applied to a notes key after it is initially pressed (illustrated as Dimension 'A'). This may be patched within existing synths, for example to Master level. This is patched in Deluge using the 'Aftertouch' parameter and can be patched elsewhere.

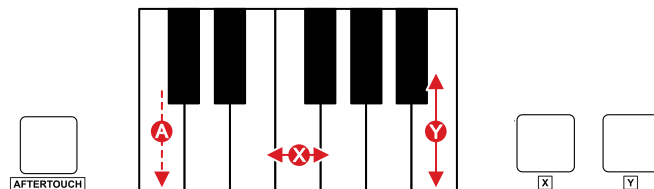

For kit rows.

- MPE can be set for kits by learning the controller note to the kit row.
- All three MPE dimensions are applicable per row including bend ranges per row.
- Non-MPE MIDI input can also allow pitch bend and aftertouch to be recorded to the row.
- Kits cannot output MPE MIDI and default, however aftertouch that has been recorded to the row will be output as polyphonic aftertouch for the rows note.

12 MIDI

12.13 Setting Up MIDI MPE

NOTES

The MPE MIDI devices can be connected to Deluge with the USB or MIDI DIN connections for inputs or outputs. Any MPE MIDI Controller would need to be 'learnt' by Deluge. Some MPE devices send MCM messages to ensure configuration is aligned between the controller and destination. This can be set manually also in Deluge.

MANUAL SET UP OF AN EXTERNAL MPE MIDI CONTROLLER

1. Connect the MPE compatible MIDI controller to Deluge using the MIDI DIN input or ideally the USB connection.
2. Select [SYNTH]
3. Press [SHIFT] + Press (SELECT) to open the settings menu.
4. Turn (SELECT) to navigate the menu and highlight MIDI, then press (SELECT).
5. In the MIDI sub menu, turn (SELECT) to highlight 'dEVIces'. Press (SELECT) to select.
6. The options will depend on the connected devices and may be represent the device by name or a generic name:-
 - DIN - MIDI DIN connected devices
 - COMPUTER - Deluge is a peripheral to a USB connected device.
7. Highlight the device to configure and press (SELECT) to open the device sub menu.
8. Highlight the 'MPE' option and press (SELECT).
9. Select the 'in' or 'out' option, typically for MIDI inputs select 'in' and press (SELECT) to choose. Controlling external gear from Deluge would use 'out'.
10. The option is presented for the 'LOWER' or the 'UPPER' Zone. It is good practice to start with the lower zone set up. Press (SELECT) to choose.
11. The number of member channels is presented. Channel 1 - Lower and Channel 16 - Upper are reserved as master channels. Set this to match the connected MPE controllers equivalent zones.
12. Optionally a VElO, Velocity setting allows a default velocity for MIDI devices to compensate for variable the MPE controller sensitivity.

Settings Options for MPE MIDI Zones

SETTINGS > MIDI > DEVICES Select the connected MPE device.

Sub Menu	Sub Menu	Sub Category	Setting Options
MPE	IN	LOWER	Member Channels OFF, 1, 2, 3, 4, 5, 6, 7, 8, 9, 10, 11,12, 13, 14, 15 (Master Channel is Channel 1)
		UPPER	Member Channels OFF, 1, 2, 3, 4, 5, 6, 7, 8, 9, 10, 11,12, 13, 14, 15 (Master Channel is Channel 16)
	OUT	LOWER	Member Channels OFF, 1, 2, 3, 4, 5, 6, 7, 8, 9, 10, 11,12, 13, 14, 15 (Master Channel is Channel 1)
		UPPER	Member Channels OFF, 1, 2, 3, 4, 5, 6, 7, 8, 9, 10, 11,12, 13, 14, 15 (Master Channel is Channel 16)

MPE Zone data is stored automatically as an MIDIDevices.xml file on the SD Card.

AUTOMATIC SET UP OF AN EXTERNAL MPE MIDI CONTROLLER

1. Connect the MPE compatible MIDI controller to Deluge using the MIDI DIN input or ideally the USB connection.
2. Select [SYNTH]
3. Press and hold [LEARN] + hold [AUDITION] + Play several notes (ideally 5 but more if possible) on the connected MPE controller. Keys will need to be simultaneous triggered. The actual number of notes pressed will aim to reflect the MPE channels in the zone set for the controller.
4. The MPE Zones and channels should now be learnt to match the connected controller.

Notes on Kits

When an MPE controller is set up as an input devices, the MPE dimensions can be recorded into individual rows of a kit. The controller note / key will need to be learnt to the kit row.

MOVING MPE NOTES

1. To change a note position, Hold Note [*PAD*] + Turn (SCROLL ◀▶).
2. The note will be relocated and the attached MPE data will move to the new location with the note.

ADJUSTING MPE NOTES VALUES

1. Ensure the MPE MIDI controller is connected and set up correctly.
2. Press and hold Note [*PAD*] for the note to adjust on Deluge.
3. While holding the Deluge note, apply the expression change on the same note on the connected MPE MIDI controller. For example apply more aftertouch key pressure.
4. Release the the Deluge and MIDI controller notes. The new MPE expression value will be recorded into the note.

12.13 MIDI MPE Output

Connecting MIDI with USB or MIDI DIN Output connections allows Deluge to control MIDI devices such as MPE compatible synths. The MPE MIDI outputs are set up in the same way as inputs within the configuration menu.

MIDI Clips that have recorded MPE MIDI from an external controller retain the expression values and therefore can play these back to the external MPE synth from the Deluge MIDI out.

Remember that MPE devices should be configured to match using the 'Upper' and 'Lower' Zones. Deluge sends MCM messages when changing the output zone or when powering up to a MPE compatible connected device. Standard MIDI channels will not be used when in this configuration.

CV

DISCLAIMER

Every effort has been made to research adequately the compatibility and safety of connecting the Deluge's CV and gate outputs to as many varieties of other equipment as possible. However, due to the nonstandard nature of CV and gate and the limitless ways in which users may choose to use these signals, Synthstrom Audible takes no responsibility for any ill effect caused by your use of these outputs. It is up to the user to verify whether a given connected piece of equipment will operate correctly and safely given the range of voltages that the Deluge may output.

In particular, if you intend to use one of the gate outputs as a trigger clock, see the warning about output voltage in the trigger clock section.

Deluge provides a variety of setting options to give as much flexibility as possible. However it's the user who decides what and how to apply these configurations and what to connect and how. Do not assume compatibility, check the connections and compatibility with all devices. Use of CV with other devices therefore is purely at the users risk.

13.1 CV Connections & Compatibility

CV

CV is a classic legacy technology used in the 1970's prior to the development of the MIDI standards. This uses a gate signal to trigger a note or event followed by a CV value to control the note pitch or value of the destination parameter although standards and compatibility for CV is less defined.



Deluge has 4 gate and 2 CV outputs which can be used to control external CV gear.

CV means 'control voltage' and typically controls pitch although other parameters can be controlled especially within modular setups.

Deluge CV output is 0v to 10v.

CV and gate are notoriously nonstandard. Different synthesizers expect to see pitch represented with voltage (CV) according to different standards, and their gate / trigger inputs may be either polarity.

The Deluge has been designed to support the widest range of CV / gate standards possible. A number of settings are available in the settings menu.

Each CV output may be set, in 0.01V increments, to any value between 0.01V and 2.00V per octave, or to "Hz per volt". Analog synthesizer manufacturers typically adopt one of several standards, examples are:

- Hz per volt - used by *Yamaha* and *Korg* (*).
- 1V per octave - used by *Moog*, *Roland*, *ARP* and *Doepfer* (*).
- 1.2V per octave - used by *Buchla* and *EML* (*).
- 0.32V per octave - used by *EMS* (*).
- 0.26V per octave - used on oscillator 3 of the *EMS VCS3* (*).

Gate

Gate is a control signal which accompanies CV control settings. Where CV controls pitch, gate controls the note on and off signals. Sometimes gate is also called trigger. Typically gate signals trigger an ADSR envelope but can also trigger a clock and other functions such as an LFO.

Deluge gate output can be switched between 5v and 12v. This switch is located on the top surface near the rear of Deluge. Each gate output may be set to either of:

- V-trig - represents a note being on by outputting a positive voltage (12V or 5V selectable), and outputs 0V the rest of the time. Used by *Roland*, *Sequential Circuits* and *ARP*.
- S-trig - represents a note being on by “shorting” out the output to ground. When the note is off, the the Deluge “pulls up” the output’s voltage to 12V or 5V (selectable) with a 10K resistor: this is not a strict part of the S-trig standard but many devices do this and it is believed to be fully compatible and safe (see disclaimer), and is in fact necessary (*) for *Yamaha* synthesizers. S-trig is used by *Yamaha*, *Korg* and *Moog*.

Trigger clock

The Deluge has a “trigger clock” input, allowing it to play as a follower to hardware which outputs a clock signal containing any number of “pulses per quarter-note” (PPQN). It can accept any voltage between 3.3V and 12V. Clock steps are read on the rising edge of the pulses. A device which has a DIN SYNC output could have pin 3 of this connector routed to the tip of the Deluge’s trigger clock input. PPQN can be set, along with an auto-start setting, in the settings menu. See MIDI section for more information about having the Deluge play as a follower to an external clock source (which could also be a MIDI beat clock). If you wish to use the Deluge as a syncing leader to send a trigger clock signal to other devices, gate output 4 can be set to output a trigger clock signal, and / or gate 3 can be set to output a “run” signal (goes high while playback is occurring; low otherwise). These output assignments are accessible via the settings menu, as is the trigger clock output PPQN setting.

IMPORTANT: many devices which receive a trigger clock signal, particularly those whose input is a DIN SYNC, aren’t happy to receive any more than 5V on these inputs.* If you wish to interface with such a device, you need to set the Deluge’s gate outputs to 5V rather than 12V.

13.2 CV Hardware Configuration

CV configuration requires the careful match up of both Deluge along with the external device for CV and gate. It is important to check the manufacturers instructions when connecting other devices. The only sound editor function available for CV is the arpeggiator.

Typical CV Set Up

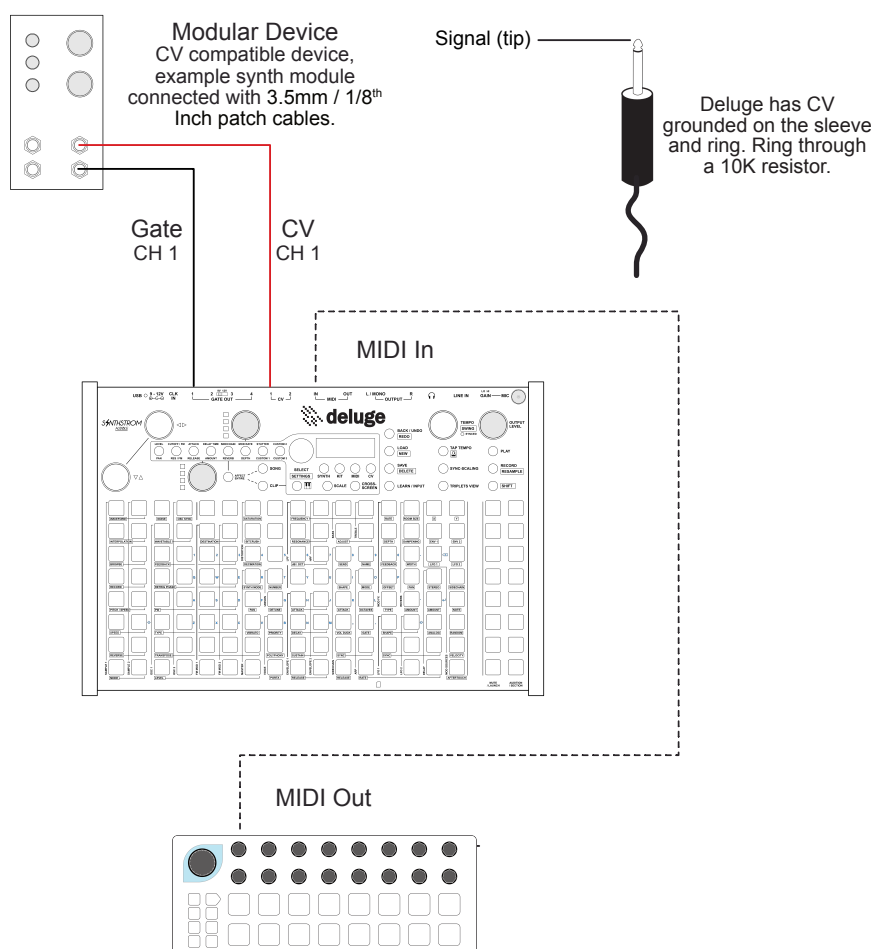

External controller providing control to Deluge. MIDI can be converted to CV within Deluge by creating a CV clip and mapping MIDI in to it.

13 CV

13.3 CV & Gate Out

NOTES

As well as samples, sounds, synths and MIDI, CV can also be combined within a kit as a row providing a note output to a CV output channel. CV sequencing can then take place alongside other kit sounds.

CREATING A BASIC CV CLIP

1. Select [CLIP] view.
2. Press [CV] to select a CV clip. Button illuminates red.
3. Turn (SELECT) to choose the CV channel 1 or 2.
4. CV will output voltage representing note pitch on this channel and also Gate will output voltage for note on/off on the same channel number.

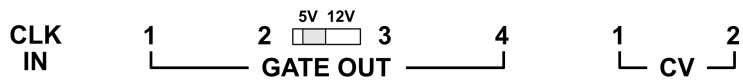

Deluge includes 2 CV outputs, 4 gate outputs (which may also be set individually to output a trigger clock and / or “run” signal), and also has a dedicated trigger clock input.

13.4 CV General Settings

The CV and gate outputs and trigger input set up is accessible in the general settings menu. When Deluge is a syncing leader and sending a trigger clock signal to other devices, the gate output 4 can be set to output a trigger clock signal, and / or gate 3 can be set to output a “run” signal (goes high while playback is occurring; low otherwise).

ACCESSING GENERAL CV SETTINGS

1. [SHIFT] + press (SELECT) to access the settings menu.
2. Turn (SELECT) to choose and highlight ‘CV’, ‘GatE’ or ‘tCLO’ - trigger clock, in-focus.
3. Press (SELECT) when the desired option is in-focus to access its parameters settings.
 - CV - options to set each output channel are provided.
 - Gate - options to set each output channel are provided plus a generic off time.
 - Trigger clock - settings for both input and output of trigger clock.

Function	Sub Category	Options	Setting Options
CV	Out 1 & Out 2	Volts per octave	Volts per octave between 0.01 to 2V can be set. Alternatively HZPV sets the CV for each output to Hz per Volt.
		Transpose	Pitch adjustment in semi-tones with cent adjustments
GATE	Out 1 - 2	Type	Sets gate output type between S-Trig or V-Trig. Gate 1-2 will automatically match to CV 1-2 when selected.
		Type	Sets gate output type between S-Trig or V-Trig
	Out 3 - 4	Run	Run, will not output notes.
		Clock	Clock, will not output notes.
	OFFtime		Minimum switching time. Time off between gate notes range 0.1-10mS
TCLO Trigger Clock	INput		PPQN - sync pulses. Pulses per quarter note. AUTO start on/off. On the presence of a trigger clock
	OUTput		PPQN - sync pulses. Pulses per quarter note

13 CV

13.5 CV Out within Kits & Songs

NOTES

As well as samples, sounds and synths, CV can also be combined within a kit as a row providing a note output to a CV channel. CV sequencing can then take place alongside other kit sounds. Also independent control of gate channels is possible within kits for CV.

CREATING / CONVERTING TO CV CLIPS WITHIN KITS

1. Select [CLIP] view and select [KIT].
2. Press & hold [AUDITION] pad for the row which will convert to CV + press [CV].
3. Hold [AUDITION] pad for the CV row to display the gate channel information.

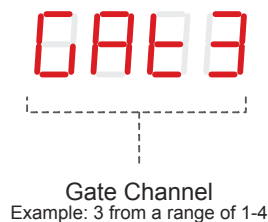

4. While holding the audition pad, turn (LOWER) control to change the gate channel. This process allows independent setting of gate channels.
5. [KIT] + [SAVE] to save the kit and retain the CV setting.

CHANGING CLIP CV CHANNEL WITHIN SONG VIEW

1. Select [SONG] view.
2. Press & hold [PAD] for the CV clip row to change + turn (SELECT) to change channel 1-2.
3. CV button will flash while holding and display will show the current channel.

— SYSTEM & GENERAL —

14 System & General

14.1 System Settings

NOTES

A number of parameter exist that are considered 'system' wide. These are accessible from the SETTINGS menu [SHIFT] + press (SELECT). Navigating the menu follows the same principle as the sound editor.

Function	Sub Category	Setting Options
CV	Out 1 & Out 2	Volts per octave.
		Transpose
GATE	Out 1 to Out 4	Sets gate output type.
	OFFtime	Minimum switching time between gate notes.
TCLO Trigger Clock	INput	PPQN - sync pulses. Pulses per quarter note.
		AUTO Start on/off. On the presence of a trigger clock.
	OUTput	PPQN - sync pulses. Pulses per quarter note.
	CLOCK	IN - MIDI beat clock input ON or OFF.
OUT - MIDI beat clock output ON or OFF.		
MAGN - tempo magnitude matching ON or OFF.		
MIDI MIDI Settings	THRU	MIDI Thru, ON or OFF.
	CMD Global MIDI Command	PLAY
		REStart - restart playback if already playing.
		RECOrd
		TAP tempo
		UNDO
		REDO
		LOOP
		LAYEr - Same as loop but with overdubs layers.
		Tempo
Swing		Applied to a new blank song upon creation.
DEFAults	KEY	Applied to a new blank song upon creation.
	SCALe	None, major, minor, Dorian, Phrygian, Lydian, Mixolydian, Locrian & rand - dedicated random setting
	VELocity	Sets the default velocity for newly entered notes between 1-127. Default is 64
	rESolution	Resolution for new songs. Options are 96, 192, 384, 768, 1536, 3072, 6144. Default is 384
	bEnd	Global pitch bend range in semitones. Range is 0-96 semitones (default 12).
	SWINg Interval	Sets the timing interval at which swing may be applied. This is song specific and saved with the song. New songs use this default - 16 th notes
	SHORtcuts	1.0 or 3.0 shortcut options to match the software version and Deluge overlay.
	KEYBoard	Style of alphanumeric keyboard, QWERTY, AZERTY, QWERTZ.
		Set mute / launch pad colours for rows as:-
PADs Shortcut / Alphanumeric layout		Active; Green, Blue, Yellow, Cyan, Purple, Amber, White, Pink, Red.
	COLOurs	Muted; Green, Blue, Yellow, Cyan, Purple, Amber, White, Pink, Red.
		Stopped; Green, Blue, Yellow, Cyan, Purple, Amber, White, Pink, Red.
		Soloed; Green, Blue, Yellow, Cyan, Purple, Amber, White, Pink, Red.

System Settings (Continued)

Function	Sub Category	Setting Options
PREView		ON / OFF/ CONDitional : Refers to the previewing of sounds from the SD card. Conditional is based on the playback mode.
CURSor		Controls appearance of the play cursor. FAST (short sharp blinks) or SLOW (solid white squares) or OFF
RECOrd	COUNt In	Turns RECORD count In ON or OFF.
	QUANtization	Sets the level at which recorded notes are quantized. OFF (192 nd notes),.
	MARGins	Sets a fade margin to avoid clicks at the loop point in an audio clip. Feature is set ON or OFF.
	MONItoring	Sampling options: ON / OFF/ CONDitional : monitor on = headphones in + mic recording. monitoring always on = line in.
FIRMWare		Indicates only the current firmware version of Deluge.

Note: Only the swing setting is saved with a song. Other parameters are not saved with song and are system specific.

CHANGING A SYSTEM PARAMETER SETTING

1. Press [SHIFT] + press (SELECT) to access the settings configuration menu.
2. Turn (SELECT) and scroll to the desired parameter. Press (SELECT)
3. Turn (SELECT) when the parameter is in-focus to change its value or setting.
4. Press [BACK / UNDO] to back up out of the menu at any time.

PERFORMING A FACTORY RESET

1. Ensure Deluge is switched OFF / powered down.
2. Press & hold (SELECT) and switch power ON to Deluge.
3. The display will blink 'RESE' to confirm reset is complete.

14 System & General

14.2 Updating Deluge Firmware

NOTES

Synthstrom are continuously developing the functionality and performance of Deluge. Firmware releases will become available at points in time that allow Deluge to be updated.

■ CHECKING THE CURRENT DELUGE FIRMWARE VERSION

1. Press [SHIFT] + press (SELECT) to access the settings configuration menu.
2. Turn (SELECT) and scroll to the 'Firm' - firmware option.
3. Press (SELECT).
4. The currently installed firmware version is displayed. No changes can be made in this menu option.
5. Press [BACK / UNDO] to back out of menu.



Firmware Option



Firmware Version

NOTES

Deluge firmware updates utilise the SD card to load the update .bin script. This needs to be prepared in advance. Ensure only one .bin file is present on the SD card when updating.

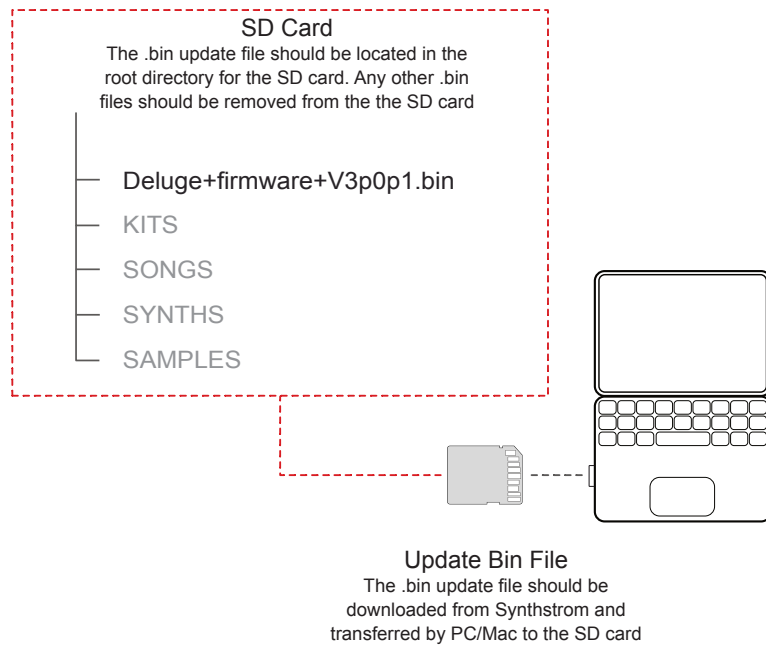

The SD card should be backed up by copying the entire content of the SD card to the PC/Mac while it is inserted.

Deluge should be powered off. Once complete the SD card with the .bin file should be inserted into the Deluge.

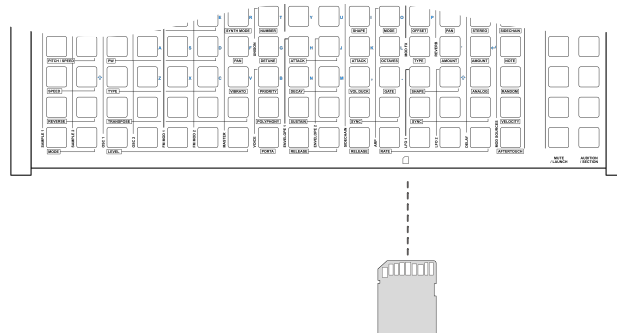

14 System & General

NOTES

PERFORMING A DELUGE UPDATE

1. Check and note the current firmware version from within the settings menu.
2. Download the latest version (a .bin file) and install onto the root directory of the SD card. This is typically performed with a PC or Mac.
3. Power Deluge OFF. Insert the SD card pins up into Deluge.
4. Ensure Deluge has enough power or is connected to a power supply. Do not switch off during the update.
5. Press & hold [SHIFT] on Deluge.
6. While holding SHIFT power up Deluge.
7. An 'UPdA' - update message is shown and then a spinning cursor will display while the update is being performed.

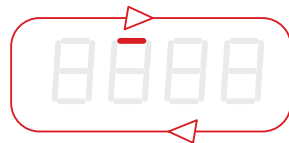

Firmware Update in Progress

8. Once complete, 'DonE' - done, is displayed.
9. Check the new version in the settings menu.
10. Deluge is ready to use.

14.3 Deluge Pad Colours

Deluge has options to change the pad illumination including colours, brightness and refresh rate. A predefined refresh rate is set for optimal user comfort. However there may be a requirement to film deluge with various devices such as smart-phones, tablets, cameras, etc. The refresh rate may be set to match your device and allow a higher quality recording of Deluge.

SETTING DELUGE USER INTERFACE REFRESH RATE

1. Press & hold [CLIP] + turn (SELECT).
2. Adjust until the flickering as observed through the camera or device has gone or been reduced. Settings above 200 and below 8 are NOT recommended as this may affect visual performance.
3. Settings are not saveable so this would need to be changed per filming session.

SETTING DELUGE PAD BRIGHTNESS

1. Press & hold [SHIFT] + [LEARN / INPUT] + turn (SCROLL ▼ ▲).
2. Adjust until the desired pad brightness.
3. Settings are not saveable.

SETTING DELUGE PAD COLOURS

1. In [CLIP] view.
2. Press & hold [SHIFT] + turn (SCROLL ▼ ▲).
3. Adjust until the desired pad colours are set. Colours will be reflected in other views. This may be particularly useful in SONG view.

Note: Default Mute / Launch pad rows colours for active, muted, stopped and soloed states can also be set in the pad menu within the settings options.

14 System & General

Quick Reference Commands

Context	Action	Command
All Views		
System	Adjust brightness	[SHIFT] + [LEARN / INPUT] + turn (SCROLL ▼▲)
System	Settings menu	[SHIFT] + (SELECT)
System	Undo	[BACK / UNDO]
System	Redo	[SHIFT] + [BACK / UNDO]
System	Tempo change	Turn (TEMPO)
System	Tempo change 1BPM inc	Push & turn (TEMPO)
System	Swing adjustment	[SHIFT] + turn (TEMPO)
System	Metronome on/off	[SHIFT] + [TAP TEMPO]
Navigation	Check current zoom level	Push (SCROLL ◀▶)
Navigation	Change current zoom level	Push & turn (SCROLL ◀▶)
Navigation	Scroll left or right	Turn (SCROLL ◀▶)
Navigation	Scroll up or down	Turn (SCROLL ▼▲)
Song	Load song (saved tempo)	[LOAD] + turn (SELECT), then [LOAD]
Song	Load song (current tempo)	[LOAD] + turn (SELECT), then push (TEMPO) + [LOAD]
Song	Delete song	[SHIFT] + [SAVE]
Song	New song	[SHIFT] + [LOAD], then [LOAD]
Song	Delay load	[LOAD], Then turn (SELECT)
Sampling	Loop resample	[RECORD] + [PLAY] then [RECORD] + [PLAY]
Sampling	Resample	[SHIFT] + [RECORD]
Sequencer	Nudge clock	Push (SCROLL ◀▶) + turn (TEMPO)
Parameter Control - Rotary Push Controls - Toggle Options		
FX	LP, HP, EQ option	[CUTOFF / RES] = on, press (UPPER)
FX	LPF slope type	[CUTOFF / RES] = on, press (LOWER)
FX	Ping-Pong on/off	[DELAY TIME / AMOUNT] = on, press (UPPER)
FX	Delay style digital / analog	[DELAY TIME / AMOUNT] = on, press (LOWER)
FX	Compressor sync 8 th - 32 nd	[SIDECHAIN / REVERB] = on, press (UPPER)
FX	Reverb room size preset	[SIDECHAIN / REVERB] = on, press (LOWER)
FX	Effect song or kit: chorus, flanger, phaser	[MOD RATE / DEPTH] & affect entire = on, press (UPPER)
FX	Effect song or kit: depth, offset, feedback	[MOD RATE / DEPTH] & affect entire = on, press (LOWER)
FX	Stutter	[STUTTER / CUSTOM 1] = on, press (UPPER)
FX	Stutter - ramp speed	[STUTTER / CUSTOM 1] = on, press & turn (UPPER)

Quick Reference Commands (Cont.)

Context	Action	Command
Song View		
Song	Clip parameter adjustment	Hold [PAD] on the grid + turn (UPPER) or (LOWER)
Song	Change section assignment / Colour	[SHIFT] + [SECTION]
Song	Section repeats / share status	Press [SECTION] + turn (SELECT)
Song	Move row	Hold [PAD] of row to move + turn (SCROLL ▼▲)
Song	Clone clip	Hold [PAD] of master clone clip + press [PAD] of another row
Song	Solo section	Tap [SECTION] pad
Song	Solo clip (arm)	Hold (SCROLL ◀▶) + press clip's [LAUNCH] pad
Song	Solo clip (Immediate)	Hold (SCROLL ◀▶) + [SHIFT] + press clip's [LAUNCH] pad
Song	Un-solo	Press clip's [MUTE] pad
Song	Instant mute / launch	[SHIFT] + [MUTE] pad
Song	Delete clip	Hold [PAD] of clip to delete + press [SAVE / DELETE]
Song	Drag clip instance to arranger	Hold [PAD] + press [SONG] + turn (SCROLL ◀▶) then release pad
Song	Record to arranger	Hold [RECORD] + press [SONG]
Looping	Create audio clip	Hold [PAD] of empty clip + press (SELECT)
Looping	Set input source for audio clip	Hold [LEARN/INPUT] + Press [PAD] of clip
Looping	Loop record	In record mode, press [PLAY] with armed, empty audio clip(s) present
Looping	Close loop recording	Press [LAUNCH] pad of clip
Looping	Close loop + immediate solo	Hold (SCROLL ◀▶) + press [LAUNCH] Pad to close loop.
Looping	Loop record during playback	In record mode, unmute armed, empty (audio) clip
Looping	Overdub	Hold [RECORD] + press [PAD] of clip row underneath
Looping	Continuous overdub layering	Hold [RECORD] + press [AUDITION] Pad of row underneath
Looping	'Loop pedal' record	Record loop while no other clip is playing / unmuted and metronome is off
Looping	Grab tempo from audio clip	Hold (TEMPO) + press [PAD] for clip row (song view) or any pad in clip view
Looping	Select MIDI switch LOOP target	Enter audio clip or hold clip row in song view + press switch
Looping	Auto extending instrument clip record	In record mode, unmute armed empty clip during playback

14 System & General

Quick Reference Commands (Cont.)

Context	Action	Command
Arranger View		
Clip	Place clip instance	[PAD]
Clip	Delete clip instance	[PAD] Leftmost start pad of an instance
Clip	Clip instance length	Hold [PAD] start + press [PAD] end on the same row
Clip	Move clip instance horizontally	Hold [PAD] + turn (SCROLL ◀▶)
Clip	Change instance clip	Hold [PAD] + turn (SELECT)
Clip	Make clip instance unique	[SHIFT] + [PAD] creates a 'white' clip instance
Clip	Adjust clip instance parameters	Hold [PAD] + turn (UPPER) or (LOWER) for the selected parameter
Clip	Enter clip view for a clip	[PAD] of any clip instance pad other than the first / leftmost
Clip	Drag 'unique' clip instance to song view	Hold [PAD] + [SONG] + turn (SCROLL ▼▲) then release pad
Row	Move track	Hold [AUDITION] pad + turn (SCROLL ▼▲)
Instrument	Mute / unmute track	[MUTE] pad for row
Instrument	Solo track	Press & hold (SCROLL ◀▶) + [MUTE] for instrument
Instrument	Change or Add new instrument	Hold [AUDITION] pad + turn (SELECT) or press [INSTRUMENT] type
Instrument	Delete track row	Hold [AUDITION] pad + [SAVE / DELETE]
Instrument	Audition instrument	[AUDITION] - Songs root note or snare drum in kit mode
Arrangement	Clear arrangement	Press & hold (SCROLL ◀▶) + [BACK / UNDO]
Audio	Create new audio track	Empty lane [AUDITION] + press (SELECT)
Audio	Set input source for audio track	[LEARN / INPUT] + [AUDITION] pad of audio track
Audio	Record audio from current position	[PLAY] while in [RECORD], with armed audio present
Clip View		
Clip	Change clip colour	[SHIFT] + turn (SCROLL ▼▲)
Clip	Change clip preset, MIDI Ch, CV out	Turn (SELECT)
Clip	Adjust clip length	[SHIFT] + turn (SCROLL ◀▶)
Clip	Duplicate / multiply and append clip content	[SHIFT] + press (SCROLL ◀▶)
Clip	Horizontal clip shift / nudge L-R	Press & hold (SCROLL ▼▲) + turn (SCROLL ◀▶)
Clip	Playback from current screen	Press & hold (SCROLL ◀▶) + [PLAY]
Clip	Clear clip	Push (SCROLL ◀▶) + [BACK / UNDO]
Clip	Change Clip Direction	[SHIFT] + [DIRECTION] Direction may not be labelled on the faceplate. Pad is located to the right of the OSC SYNC pad on the FM MOD 1 Column.

Quick Reference Commands (Cont.)

Context	Action	Command
Clip View (Cont)		
Note	Note length	Hold [PAD] start + press [PAD] end on the same row
Note	Note length - long	Press [PAD] start. Navigate grid - turn (SCROLL ◀▶). Hold (SCROLL ◀▶) + press [PAD] end on the same row
Note	Note velocity	Hold [PAD] on the grid + turn (SCROLL ◀▶)
Note	Note repeat	Hold [PAD] on the grid + hold and turn (SCROLL ▼▲)
Note	Note play probability %	Hold [PAD] of note + turn (SELECT) anticlockwise / left
Note	Set dependance on first note	Hold All [PAD]s together + turn (SELECT) anticlockwise / left
Note	Iteration dependance for a note	Hold [PAD] of note + turn (SELECT) clockwise / right
Note	Copy notes	Hold [LEARN / INPUT] + press (SCROLL ◀▶)
Note	Paste notes	Hold [LEARN / INPUT] + [SHIFT] + press (SCROLL ◀▶)
Note	Nudge individual notes horizontally	Hold [Pad] + press and turn (SCROLL ◀▶)
Parameter	Automate a parameter	While recording, LED on; turn (UPPER) or (LOWER) of selected parameter
Parameter	Per note parameter change	Hold [PAD] of note start + turn (UPPER) or (LOWER) of selected parameter
Parameter	Delete parameter automation	[SHIFT] + press (UPPER) or (LOWER) of selected parameter
Parameter	Copy automation	Hold [LEARN / INPUT] + press (UPPER) or (LOWER) of selected parameter
Parameter	Paste automation	Hold [LEARN / INPUT] + [SHIFT] + press (UPPER) or (LOWER) of selected parameter
Sample	Load sample	[AUDITION] + [LOAD]
Sound	Sound Editor	[SHIFT] + [PAD] of shortcut as labelled or press (SELECT)
Preset	Preset load interface	[LOAD] + [SYNTH] or [KIT]
Audio	Audio clip trim	Press [PAD] of rightmost column at the end of the waveform
Euclidian Seq	Number of events on the row	Hold [AUDITION] + press & turn (SCROLL ▼▲)
Euclidian Seq	Row length	Hold [AUDITION] + turn (SCROLL ◀▶)
Euclidian Seq	Rotate / Shift events or notes	Hold [AUDITION] + press & turn (SCROLL ◀▶)

14 System & General

Quick Reference Commands (Cont.)

Context	Action	Command
Sound Editor		
Sound Editor	Move cursor	Turn (SCROLL ◀▶) to navigate
Controls	Parameter knob assignment	Hold [LEARN / INPUT] + turn (UPPER) or (LOWER) parameter control
Controls	MIDI knob assignment	Hold [LEARN / INPUT] + turn (MIDI) Control of external device
Controls	Unassign MIDI control knob	[SHIFT] + [LEARN / INPUT]
Preset	Save preset	[SAVE]
Parameter	Apply a change to entire kit	Press & hold [AFFECT ENTIRE] while changing parameter i.e. Polyphony, mode, reverse, speed, pitch/speed)
Synth, Keyboard, MIDI, CV Clips		
Synth	Synth resample	[RECORD] + [AUDITION] or grid [PAD]
Synth	Load blank synth	[SHIFT] + [SYNTH]
Synth	Save synth preset	[SAVE / DELETE] + [SYNTH]
Synth		
Scales	Cycle through default scales	[SHIFT] + [SCALE]
Scales	Change root note	[SCALE] + [AUDITION] pad row of new note
Scales	Chromatic scale	[SCALE] to turn it OFF, LED unlit
Scales	Create scale	In chromatic mode - scale OFF; Select [PAD] notes, then press [SCALE]
Scales	Alter current scale	Hold [AUDITION] pad + press & turn (SELECT)
Transpose	Transpose current clip an octave	Press & turn (SCROLL ▼▲)
Transpose	Transpose current clip a semitone	In chromatic mode - Scale OFF; [SHIFT] + press & turn (SCROLL ▼▲)
Transpose	Transpose ALL clips a semitone	In scale mode - scale ON; [SHIFT] + press & turn (SCROLL ▼▲)
Note	Create full screen 'drone' note	Hold [PAD] first column + press [PAD] last column of grid
MIDI	Assign MIDI CC to parameter knob (MIDI Track)	Press & hold (UPPER) or (LOWER) + turn (SELECT)

Quick Reference Commands (Cont.)

Context	Action	Command
Kit Clips		
Kit	Change colour of specific row	[SHIFT] + [AUDITION] + turn (SCROLL▼▲)
Kit	Create new kit	[SHIFT] + [KIT]
Kit	Save kit preset	[SAVE / DELETE] + [KIT]
Kit	Move row	Hold for row [AUDITION] + [MUTE] + turn (SCROLL▼▲)
Kit	Delete row	[PAD] for row to delete + [SAVE / DELETE]
Sample	Slice a sample	[SHIFT] + [KIT], Turn (SELECT) to choose sample, [SHIFT] + Press (SELECT)
Sample	Record sample from input	[AUDITION] + [RECORD] to start recording. [RECORD] again to end
CV	Set kit row output to gate	[AUDITION] + press [CV]
CV	Set kit row CV gate	[AUDITION] + turn (LOWER) - must be set as a CV row
MIDI	Set kit row output to MIDI	[AUDITION] + press [MIDI]
MIDI	Set kit row MIDI channel	[AUDITION] + turn (LOWER) - must be set as a MIDI row
MIDI	Set kit row MIDI note	[AUDITION] + turn (UPPER) - must be set as a MIDI row

14 System & General

14.3 Deluge CPU Performance

NOTES

Processing power and CPU management

Deluge does not enforce firm limits on how many tracks or voices may sound at once thus allowing the user as many as they wish. The ultimate limitation will inevitably be based on Deluge's CPU loading especially from concurrent voices or effects. Under conditions of high CPU loading, Deluge will switch off a synth or sample voice to lower its load. Deluge will attempt to do this in the most subtle way possible, preferring to switch off voices which are "releasing", and those which have been sounding for the longest time.

Unaffected sample voices are very light on the CPU. This has been tested with a measure of up to 110 sounding at once. For synth voices, the most simple ones are light enough to allow around 64 to play.

The Deluge's analog-modelled oscillator types and drive filter consume a little more CPU than the other types, but not enormously more.

Considerations for CPU power :-

- Analog-simulated delay, time stretching, and pitch shifting (where pitch and time are treated independently - including live audio input) are the highest CPU users.
- All other effects and synth features, though lighter, will add to the CPU's load as well.
- Synths with unison switched on will multiply the amount of processing power that that synth consumes.
- Arpeggiation can generate a lot of CPU-eating voices very rapidly, which can add up if polyphony is on (is set to POLY) and if the release time is long. Try changing these parameters if you notice voices cutting out on your song.
- There is a slight CPU overhead for each sound present in the Deluge's currently loaded song - even if it is not sounding at a given moment. This may begin to affect CPU performance if you have more than 50 to 100 sounds loaded. For this reason, you may wish to refrain from importing large folders of samples as kits where these are not in-fact used. Multi-sampled instruments, count as just one sound regardless of how many separate samples they contain.
- Voice priority can be manually set for a sound, to tell the Deluge which voices to consider (or not) dropping first - see sound editor.
- See sample interpolation / pitch for some additional notes on CPU usage.

Sample interpolation / pitch

Whether or not actual “pitch shifting”, the process of treating pitch and speed independently, is applied, another process called interpolation is needed anytime a sample needs to be played back at a different pitch, or if its sample rate is different to the Deluge’s native 44.1kHz.

Since firmware V2.1, Deluge utilises 16-point windowed-sinc interpolation for high-quality sample pitch adjustment with minimal aliasing. If you prefer the more “bitcrushed” sound of linear interpolation, which was used prior to V2.1, see the INTERpolation setting in the sound editor.

Songs and presets created with pre-V2.1 firmware which include sample pitch adjustment will continue to default to linear interpolation, to keep your older projects sounding the same.

The 16-point windowed-sinc interpolation uses a little more CPU power than the lower-quality linear interpolation, but not very much more, thanks to the hardware acceleration features of the Deluge’s CPU. If the Deluge’s CPU becomes overloaded, it may revert to using linear interpolation in some cases. It is not recommended that you manually switch to linear interpolation purely for the purpose of saving CPU power - it won’t have this effect in all cases.

Sample and RAM management

The Deluge streams audio samples directly off the SD card, meaning there is no practical limit on the amount of sample content that may be used per song, and the user does not have to wait for all sample data to be read when loading a song.

You may eject the SD card at any time, the only adverse effect being that if the Deluge is playing any sample, it may stop, and samples may not play correctly until the card is reinserted.

The Deluge has 64MB of working RAM, which is mostly available to hold the currently loaded song’s synths, parameters, and sequenced notes. It’s unlikely that the 64MB limit would ever be reached - this would be enough to hold over 2 million notes.

There may be cases, if both songs contain a lot of samples (i.e. near to the Deluge’s 64MB RAM limit), where the newly loaded song may fail to play some sounds for the first couple of seconds. However, the Deluge does everything it can to avoid such a case, by first discarding any not-currently-playing samples in the old song, and if necessary delay the loading of any not-currently-playing samples in the new song until the old song has been discarded completely.

14 System & General

14.4 USB Host Mode for Devices

NOTES

The USB connection can also be used to host USB MIDI devices. In order to use this feature, you must power your Deluge via its DC power socket (centre-negative) - the feature is not available when running the Deluge on its battery.

The Deluge is able to deliver a little bit of power to connected devices, but this is very limited. More basic controllers without too many LEDs should work in many cases, but bigger controllers with advanced features may not. If your MIDI controller has the option to provide it with power externally, that will enable it to work in most cases.

Deluge supports one USB MIDI 'hub' devices as a host. Powered USB Hubs are also useful in powering up Deluge as well as other connected USB devices. Deluge will blink "MIDI" for a working MIDI device, or "UNKNown" for anything else. Multiple hubs especially more than four connected may not operate correctly and "FULL" is displayed if more than four devices are connected. Deluge will blink "HUB" when a connected hub device is detected and working and "DETACH" when a devices is detached. If your device doesn't work and you get no error message, it may be a power issue.

If your device doesn't work and you get no error message, it may be a power issue - see above.

MIDI USB devices are supported for MIDI input and output.

■ DELUGE AS USB HOST WITH A USB DEVICE

1. Connect the USB device to Deluge with the USB connection
2. Connect a DC power supply to Deluge. Host mode does not work when Deluge is operating from its battery
3. Power ON Deluge
4. USB Host mode will be activated.
5. The USB device can now be connected and reconnected. A reboot is required if a PC is to be connected.

14.5 Deluge Legacy Shortcuts 1.0

Version 1.0 Grid Shortcuts

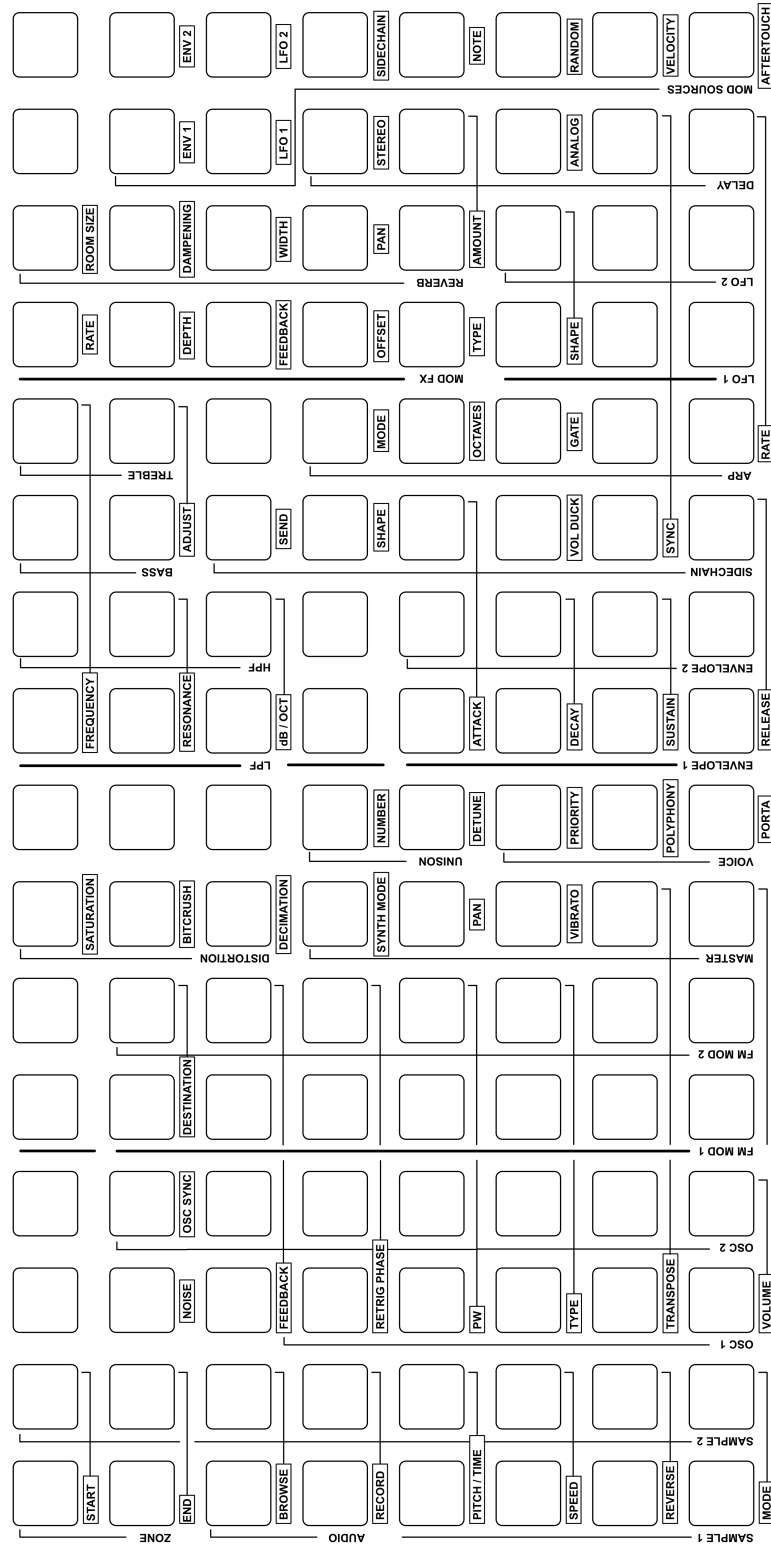

14 System & General

14.6 Acknowledgments

Thank you to those in our amazing community and to all users who have supported the Deluge. Thank you to our beta testers who have provided valuable feedback

Thank you to those who have generously donated synth presets for our official collection,

- Marcel Bellve, tinyurl.com/y73dozIt
- NJM, soundcloud.com/staysun
- Guilherme Gomes, ohdeo.com
- Steve Swisher, youtube.com/steveswisher
- Stephen Scofield
- Luke Rowell, disasteradio.org
- Ron Cavagnaro, youtube.com/channel/UCAuuJw6Au8-k1WDIqmvmnSA
- Jeremy Blake (Red Means Recording), youtube.com/jjbbllkk
- Joey Esposito - Moralz, soundcloud.com/moralz
- Travis Hampton, youtube.com/channel/UCItwiftFumcCro94jT5YA4Q
- Matt Bairstow, soundcloud.com/tactile-af
- Jani Hakala, soundcloud.com/moobius
- Pawel Czubak, soundcloud.com/dj-spyler
- Neil Baldwin, marmotaudio.co.uk
- Brad Antone
- Franz Keller, youtube.com/VJFranzK
- Daniel Stern
- Michael Bath, soundcloud.com/workergray
- Ron Rapprich, soundcloud.com/ron-rapprich
- Leonard Ludvigsen aka Icoustik
- Michael J. Bulaw - Too Mere, soundcloud.com/meremush

Thank you to those who have generously donated Kit presets for our official collection,

- Andrew Stirton (Frugal), soundcloud.com/frugaltunes Fairburg, fairburg.bandcamp.com
- Electronisounds <http://electronisounds.com>
- Leonard Ludvigsen aka Icoustik
- «hodeur» <https://soundcloud.com/hodeur>
- James R Closs, <http://redmeatrecords.uk>
- Amiga909, https://mixcloud.com/roman_hats/
- Reciprocal Sound, <https://reciprocalsound.com/>
- Danny Taurus, <https://meatbeats.com>

The Deluge official guidebook and producer guide

The Deluge guidebook is a collaboration between Synthdawg and Synthstrom Audible where Ian Jorgensen and Rohan Hill have provided essential information and guidance. In addition a special mention to Michael J Bulaw who has also been a valuable contributor throughout the development of the guide and has provided feedback and input as an integral member of the collaboration team.

— COMMUNITY GUIDE —

Deluge Unit

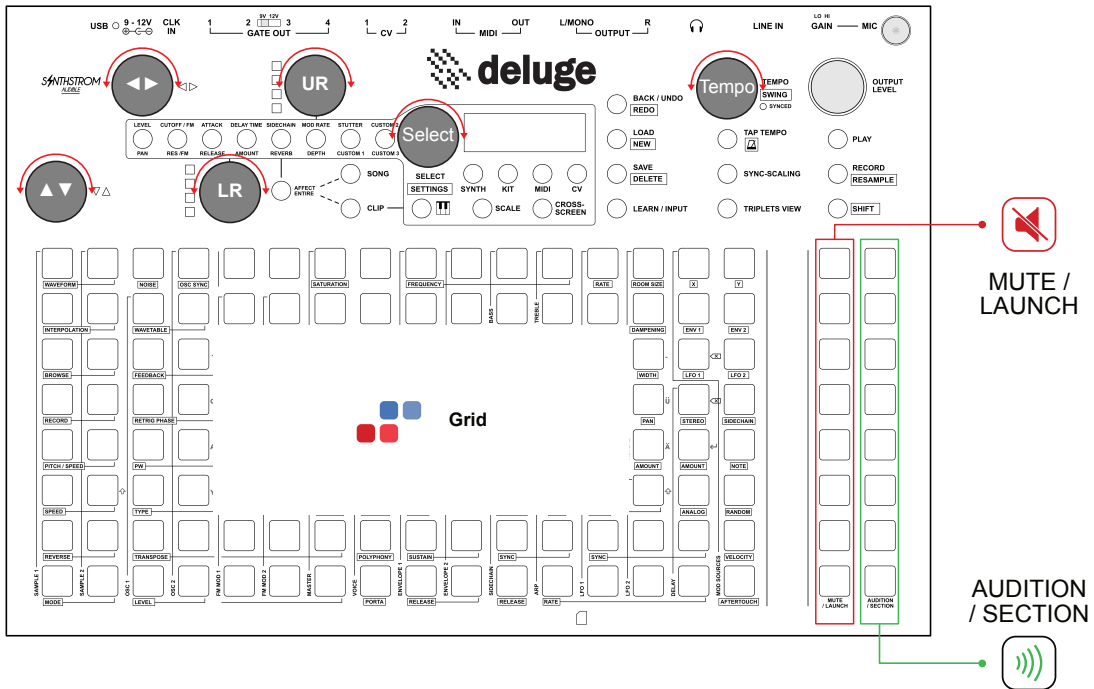

Deluge Screen Characters

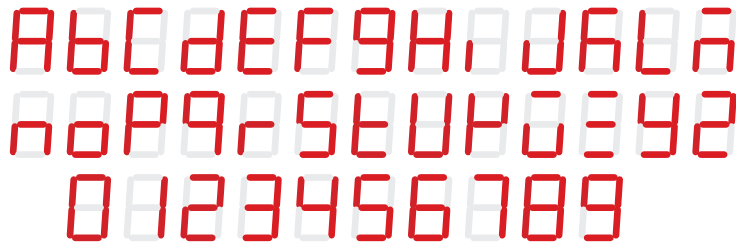

Description	Example
Symbols next to each other <i>Operate in order</i>	 Load Load Press Turn Press
Single '+' plus sign <i>Operate together</i>	+ Hold and Press
Multiple '+' signs <i>Operate together</i>	+ + Hold and Hold and Turn
Push & turn dials	 Red Arrow - Hold first, then turn

Description	Example
Long press dials	 'H' in the black hold arrow
Shortcut Locator	 Function Button Position on the 8x16 Grid where 1,1 in red starts top left pad. Black arrows start top right. Parameter
Prerequisites	PreReq MC01 For command to work, must follow the ref command first or be in same end-state
Context / Mode indicators	All Clip Types Arranger Mode Song Mode Global MIDI Kit Specific clip types

GL01		Zoom Level		To View		To Change	White notes in song and clip mode require zooming in to see exact position in the timeline	
GL02		Scroll Grid		Up/Down		Left/Right		
GL03		Undo Redo		Back / Undo Undo		Back / Undo + Shift Redo	If a preset is changed or you enter sound editor undo/redo history is cleared	
GL04		New Song		+ Shift				
GL05		Delete Song			+ Select	Scroll to song to delete		
GL06		Load Song			+ Select	For gapless play, hold to delay launch if large samples are included	Hold SHIFT & Turn SELECT to fast scroll songs on display	
GL07		Load Song Keep current tempo			+ Select			
GL08		Load Song Delay Song Change			+ Select			
GL09		Save Song			+ Select		Song slots with a '.' after its name means it already exists and 'OVERwrite' will flash when trying to save. A,B,C designate version iterations of same song.	
GL10		QWERTY Keyboard Searches					...In song loading where the keyboard is hidden to enable viewing scrolling content. Tap grid to bring up keyboard.	
GL11		Change Tempo		or			Press and turn for 1 BPM increments. See SQ10 for secret tempo power up.	
GL12		Metronome		+ Tap Tempo				

GL13		Swing	+	<i>Default 50% is no Swing</i>	Swing interval is 1/16 th notes by default but can be adjusted in the settings menu.
GL14		File System Up	Back / Undo / Redo 		Back UP one level from within the file system.
GL15		Adjust Brightness	+ +		
GL16		Firmware Update	+		Power on deluge from an off state whilst holding the SHIFT button. One firmware bin file must be in the SD Card root folder
GL17		Settings Menu	+		
GL18		Open Sound Editor	<i>To then scroll the file / directory names....</i>		The sound editor offers more setting options than available via the shift + grid shortcuts
GL19		Save Song Collect All Samples	Save / Delete 		This option saves the song and creates a folder with the same name and save all used sample files inside under / SONGS
GL20		Pad Refresh Rate	+		Used to change pad refresh rate which can help when video recording the pads.

SQ01		Make Long Notes			Select the two grid buttons on the same row of the grid	
SQ02		Make Long Notes Across the next screen		Move to next screen	Select the two grid buttons on the same row of the grid	
SQ03		Adjust Note Velocity		Multiple notes can be selected	New notes added will default to the last velocity setting. Default is 64, Range is 0-127.	
SQ04		Note Probability Set note iteration		Counter Clockwise = Probability Clockwise = Iteration		
SQ05		Note Probability Group			When probability is the same and all notes will follow action of first note in the sequence (sound or note). A ' ' Signifies probability group exists.	
SQ06		Copy Notes	Learn / Input		Copy / Paste applies to all notes in the vertical columns at the current zoom level, including those notes not visible, above and below the grid	
SQ07		Paste Notes	+ Learn / Input		Copy / Paste applies to all notes in the vertical columns at the current zoom level, including those notes not visible, above and below the grid	
SQ08		Cross Screen Editing Real-time note cloning	Cross - Screen		Cross-screen mode is linked to zoom level. Cross-screen mode on/off if wanting to apply changes at different zoom levels	
SQ09		Add Instrument / Row Add to a kit	Blank / Unused row + Kit		Scroll to sample, back to go up one level.	
SQ10		Note Zoom Level 128 th & 256 th Level	Learn / Input	Tempo Counter-Clockwise		
SQ11		Record Live Notes into Deluge sequencer	Play Record Resample	On, then or or		
SQ12		Duplicate Clip Content Double and append	+			

SQ13		Reduce Clip Length		Poly Rhythms	
SQ14		Shift All Clip Notes Horizontally Left / Right			
SQ15		Clear Clip			
SQ16		Change Clip Colour			
SQ17		Change Row Colour Instrument row in a kit clip			
SQ18		Re-order Kit Clip Row Up or Down			
SQ19		Note Nudge Individual Notes			
SQ20		Note Repeat			
SQ21		Clip Play Direction		Pad may not be labelled on the grid	
SQ22		Euclidian Seq Events Number of Events / Notes			
SQ23		Euclidian Seq Length Row Length			
SQ24		Euclidian Seq Rotate Shift / Rotate Events or Notes			





















































SONG VIEW

SV











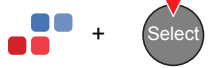

























Song		Song Mode ON, Button Lit (not flashing)	
SV01		Stop / Launch Clip	Stop / Start of next loop + Stop / Start instantly
SV02		Fast Scroll Song List	Load New + Shift +
SV03		Create New Clip	On A Blank / Unlit Row + Song To return to song mode <i>Will create and enter clip view. Can create unlimited clips. Scroll up/down in song mode to view more rows.</i>
SV04		Enter Clip To view / edit	On A Blank / Unlit Row + Song To return to song mode
SV05		Move Row Clip Up or Down	On A Blank / Unlit Row +
SV06		Clip Section Colour Change for section or create new	Load New + Section Colour <i>Will cycle through all existing colours. If the end is reached a new colour will be created. Maximum 12 sections / colour.</i>
SV07		Launch Section	Section Colour <i>All audition / section rows of the same colour will flash then launch</i> + Section Colour <i>Clip will begin in time when the current longest playing clip loops / starts again</i>
SV08		Section Repeat Share Status	Section Colour <i>Hold for 1 Sec</i> + Select <i>Change INFinite to # times for section to repeat. Display will countdown.</i> + Select <i>Press select to cancel section switch during countdown</i>
SV09		Clone Clip	On A Blank / Unlit Row <i>Source clip row</i> + On A Blank / Unlit Row <i>Destination clip row</i> + On A Blank / Unlit Row <i>Destination row can be another existing clip - clones clip will be inserted.</i>
SV10		Delete Clip	On A Blank / Unlit Row + Save Delete <i>Cannot undo delete.</i>
SV11		Solo Clip Arm	Solo + Mute <i>Clip turns blue, other mute pads dim</i> + Mute <i>Can solo >1 clip. Press Mute/Launch to unsolo</i>
SV12		Solo Clip Immediate	Load New + Solo + Mute + Mute <i>Can immediately solo >1 clip.</i>

	Song						
		Song View ON, Button Lit (not flashing)					
SV13		Clip Parameter Change Per Clip (Song View)		+		Or	
SV14		Song Parameter Change Per Song (Song View)				Or	
SV15		Change Existing Clip PRESET or Clip Type		+		Or Clip Type ...	Or Or
SV16		Check Name Of a Clip or Instrument name and type on clip row			<i>Hold row button</i>		<i>LED will flash with the name of the clip and clip-type LEDs will light up (eg MIDI)</i>

All samples must be preloaded onto the SD Card in the /Samples folder (or a sub folder) only

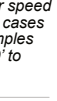
RS01	 Resample / Record All audio output	 +  Resample + ...  Resample <i>To Stop</i>	
RS02	 Loop Resample	 Resample +  + ...  Resample + 	<i>Repeat Rec + Play before end of loop. If playing already, Hold Rec + Play to Quantize Rec to start loop.</i>
RS03	 Record Sample Into a kit	 +  +  Resample	<i>Better for offline recording instead of using Audio Clip or Live Looper Recording.</i>
RS04	 Load Sample Into a kit row	 +  New +  	<i>Scroll to sample and press select. Also, Shift+ Browse grid shortcut on an existing row to open browser.</i> 
RS05	 Load Sample Into a kit or synth silently	 +  +  New +  	 
RS06	 Synth Resample	 Resample +  or  +  Resample + 	<i>Rec to Stop.</i> 
RS07	 Load All Samples From SD Card folder to a kit	 +  +    <i>Choose 'ALL'</i>	<i>Scroll to parent folder of the samples wanted, or a sample within the folder.</i> <i>Beware of CPU/Mem overhead when loading large amounts of samples into kits. Best to keep KIT files minimal for best performance. Note: Does not apply to multi-sampled synths.</i> 
RS08	 Slice Sample	 +  +      <i>Choose 'SLICE' Select # of slices 2-256</i>	<i>Scroll to sample.</i> <i>Note: can add more samples to the sliced kits (SQ09) but not slices to existing kits. Only 1 sliced sample per kit possible</i> 
RS12	 Rename Kit row or instrument	 + 	

After recording samples into a kit, the Deluge digitally normalises the volume level of a recorded sample to make it as loud as possible without clipping. Note: Recorded audio clips are not normalised in this way.

AC01		Create New Audio Clip In Song View		On an empty row	
AC02		Input Source Audio clip in Song View *	Learn  + 	 	
AC03		Create New Audio Track In Arranger View	 + 		
AC04		Input Source Audio Thru Monitoring in Arranger View *	Learn  + 	 	Choose a '!' Input source. Pre-requisite (AC03) for this feature. 
AC05		Clear Audio Clip Recording	 + 	Must be in Clip Mode, not Song or Arranger, to delete current Audio Recording.	
AC06		Change Colour Of Audio Wave	 + 	Must be in Clip Mode	
AC07		End Point / Loop Length Change Audio Clip End / Loop		Right most column	 Tap new position on the grid to shorten or lengthen. 
AC08		Waveform Start / End Point Change Audio Clip Waveform	 + 	Clip is still time-stretched and shortened clips in waveform view play at slower speed to fit same time window. Limited use cases for this - may be better to record samples (RS03). Then may need to run 'LO09' to apply original tempo again.	
AC09		Adjust Length Audio Clip Waveform	 + 	May need to run 'LO09' to apply original tempo again.	

* AC02 / AC04
Input Sources & Monitoring

- LEFT: Default. Left or Mono input (line or mic). Use for internal Mic too and disconnect any cable from the line in port
- RIGHT: Second mono input if using left already
- STEReo: Stereo line or mic input
- BALAnced: For mono signal via TRS cable - but balanced output into Deluge line in.
- MIX: Deluge audio output, minus master FX, level adjustment and reverb
- OUTPut: Deluge audio output, with post FX and reverb. Same output as when resampling. Normally not the best option for recording or bouncing audio clips though - use MIX instead.
- OFF - No audio input, recording disabled.

‘!’ After the input source enables audio monitoring. Applies to LEFT, RIGH, STER and BALA Options only.

MS01		New Synth / New Kit	+ <i>or</i>	
MS02		Save as New Preset	+ <i>or</i>	
MS03		Note Keyboard View	<i>Does not work in kit view</i>	<i>Can still change presets and parameters in keyboard view.</i>
MS04		Clear Notes & Automation	+	
MS05		Choke Group Setting Up	+ <i>Select 'CHOke'</i>	
MS06		Cycle Default Scales	+	
MS07		Change Root Note Of current scale	+ <i>New root note</i>	
MS08		Chromatic Scale	<i>Unlit</i>	<i>All note rows in this mode are a semitone apart</i>
MS09		Alter Current Scale	+	<i>To sharpen or flatten a note. Scale must be lit or else all notes / semitones present. Prepend Shift + to do so silently</i>
MS10			<i>ON</i> <i>Row: Grey / Unassigned</i> +	<i>Can now setup kit sounds from the synth engines, e.g. using FM Drums</i>
MS11		Clone Preset For Synth or Kit	+ <i>Scroll to preset you want to clone</i> <i>CLONe</i> <i>Hold</i>	<i>A single preset can only appear in one active clip so need to CLONE the original preset for multiple instances in same song. Good practice is to Clone first if tweaking and to avoid affects on inter-dependant songs.</i>

MS12		Kit Clip Affect All			<p>Limited to Polyphony, Mode, Reverse, Speed, Pitch/Speed. Applies to all rows in a kit.</p>
MS13		Select Kit / Instrument Row Silently		<p>Row is selected, instrument or sample name flashed in LCD screen but no note sounds. Can then modify parameters, change presets etc</p>	
MS14		Change Clip Preset			
MS15		Transpose Clip Current Clip by Octave			
MS16		Transpose Clip Current Clip by Semitone			
MS17		Transpose Clip All Clips by Semitone			

Loading Samples & Multi-samples as Synths

WF01

Step 1 Create New Synth and open file browser
 + + Or... Shift + Browse or Audition + Browse

Step 2 Choose Range and browse to sample
 BOT-TOP Shown. See (WF02) prior to selecting. Scroll through folders to select a sample, or a parent folder for multis

Step 3 Select Sample Type and browse to sample
 A. Press once to load as a chromatic sample - same sample, different pitches.
 B. Hold and turn to select BASic to load a sample with no pitch detection
 C. Hold and turn to select MULTi for multi-sampling. See (RS14)
 D. Hold and turn to select SINGle for single cycle waveforms. See (RS11)

Deluge detects the pitch of provided samples regardless of filename, though best to order multi-samples on SD card Low to High where possible.

WF02

BOT-TOP Range Option Sound Test or Sound test when 'BOT-TOP' edit mode is active.

BOT-TOP Range Option Adjust Range Select Upper or Lower Range Counter-Clockwise = Lower Clockwise = Higher Adjust Selected Range

Select range of notes / keys to load into when following (WF01)
 Default range 'BOT-TOP' is active and used typically for single samples and can be retained or changed for multi samples.

+ Insert new range

+ Delete selected range. Can keep deleting until back at 'BOT-TOP'

WF03

Single Cycle Waveforms

- Sample <20ms. Follow (WF01), Option A. Deluge will automatically transpose to a C and set loop mode.
- To force samples to same mode. Follow (WF01) Option D. Deluge will auto transpose to a C and set to loop mode.

WF04

External Sound Source as an oscillator

+ and / or OSC 2 IN*

Can pitch shift around source by changing from C3 to hi or lo notes or play chords with several notes in seq at once.

Syn

Create Drone note on C3 to match pitch.

Play

Use a stereo to mono adapter and get one sound source on OSC1, INL and another on OSC2, INR

Record to Arranger

WF05

Record to Arranger Mode

Resample + Resample

Song Mode Both record and song buttons flash

In this mode..... + &

Live record parameter changes. Also record MIDI notes and parameter changes on pre-existing and MIDI learned clips

Play or song stops recording. While this mode is active you cannot change to clip or arranger modes. If you unmute a clip after its start point, the arranger will record place the whole instance into arranger

Syn

Record to Arranger (Cont)

WF06

Append Recording
Live recording to existing arrangement

Song (flashing) **Record** (flashing) *Flashing Arranger Mode*

Move play bar to point where you want to append new live recording to arranger

Song (flashing) **Record** (flashing) **Resample** + **Song** (flashing) **Record** (flashing) **Resample**

Everything to the right of the play bar in arranger is deleted and new recording appended. Can UNDO if a mistake is made.

S **A**

Waveform

WF07

Waveform View
To edit; Start, End and Loop points

Shift + **SAMPLE 1** **WAVEFORM** or **SAMPLE 2** **WAVEFORM**

WF08

Zoom In and Out
And move along the waveform

+ **↔** & **↔**

WF09

Change Start / End
Points of the sample

Click anywhere on the green or red bar until they flash. Then click on the target column to move to.

WF10

Loop Start Point
Create and move loop start

Hold GREEN bar and click on the grid to the right to create.....

... Loop START. Bar can be moved same way as start / end bar.

WF11

Loop End Point
Create and move loop end

Hold RED bar and click on the grid to the left to create.....

... Loop END. Bar can be moved same way as start / end bar.

WF12



Delete Loop Points
Delete loop start and / or end

























































For start, hold anywhere on the blue start loop-bar and press the start green bar. For end, hold anywhere on the purple end loop-bar and press the end red bar. Loop points will disappear.

ARRANGER VIEW



Song		Arranger View ON, Button flashing	
AV01	Add Clip Into arranger		
AV02	Change / Select Instance's clip		<i>This command is fundamental to arranger principles</i>
AV03	Delete Clip Instance From arranger	<i>Fully lit left-most grid button will delete instance from arranger only</i>	<i>This command can be undone and redone.</i>
AV04	Clear Arranger Clips All clip instances	+	
AV05	Move Clip Instances Horizontally across grid		
AV06	Move Row Up / Down		
AV07	Change Instance Length of clip	<i>Start</i> <i>End</i>	<i>Used to shorten as well as lengthen clip instances.</i>
AV08	Mute / Unmute or audition instrument	<i>To mute</i> or <i>To audition</i>	<i>Audition will sound a synths root note or a kit row instance</i>
AV09	Solo Instrument	+ <i>Mute pads turns blue. Can solo >1 instrument at same time</i> <i>Unsolo press blue</i>	
AV10	Enter Clip to view or edit	<i>Click on instance tail only</i>	<i>Pressing play after entering a clip in this way will continue arranger from the start of this clip</i>
AV11	Scroll Timeline with progress bar		<i>Only works when play is on and progress bar is visible</i>
AV12	Start Playback From current screen	+	<i>Play will begin from the left most column visible</i>

 **Song**
 Arranger Mode ON, Button flashing

AV13		Make Clip Unique Instance made unique (white)	 +  <i>Left most grid button.</i>	<i>The coloured instance will turn white to indicate unique, but contains all note and parameter data too.</i>	
AV14		Adjust Clip Parameter Of clip instance.	 +  Or  <i>Chosen</i>		
AV15		Copy Clip From Arranger to Song Mode	 <i>Grid button of clip instance.</i> +  	<i>E.g. to save white instance as its own clip. Can scroll before releasing to place instance.</i>	
AV16		Copy Clip From Song to Arranger Mode	 <i>Grid button of clip instance.</i> +  	<i>Can scroll before releasing to place instance.</i>	
AV17		Insert / Delete Time 88 BPM Not Required	 +  <i>Counter Clockwise = Delete Time Clockwise = Insert Time</i>	<i>Applies to currently visible screen. Notes 'falling off' left side deleted. Press back to undo</i>	
AV18		Switch Loop Play Mode From arranger to song mode	 or 	<i>Playing instruments will be indicated by coloured lit audition buttons. Once a button is pressed all the audition buttons are lit showing loop mode active.</i>	
AV19		Switch Loop Play Mode From song loop to play in arranger	 <i>Until flashes</i>  + 	<i>Play will switch from clip loop mode to arranger at left most column visible. Will change at end of loop, in time with seq.</i>	
AV20		Change Instrument Preset Change existing preset or clip type	 +  Or  Or  Or  <i>Not for Audio Clips</i>		
AV21		Add New Instrument Clip From within arranger view	 <i>Greyed out button, unused row.</i> +  Or  Or  Or 		
AV22		Delete Instrument & Row From arranger	 +  	<i>If row contains unique / white instances they will be lost completely.</i>	
AV23		Rename Track	 +  	<i>Only way to rename tracks is in arranger mode.</i>	

PARAMETER DIALS

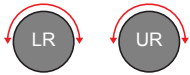

		Parameter Indicator		
-	Pan Left & Right		Level	-
LPF* Options <u>24db</u> , Drive, 12db	Resonance / FM		Cutoff / FM	<u>LPF*</u> , HPF, EQ
-	Release		Attack	-
Delay Type <u>Digital</u> , Analog	Delay Amount		Delay Time	Delay Output <u>Normal</u> , Ping Pong
Reverb Room Size <u>Medium</u> , Large, Small	Reverb		Sidechain	Compressor Sync <u>Slow</u> (8 th Notes) Fast (32 nd Notes)
Affect Entire <i>ON</i> Modulation <u>Depth</u> , Feedback, Offset	Mod Depth		Mod Rate	Affect Entire <i>ON</i> Modulation Type <u>Flanger</u> , Chorus, Phaser
-	Custom 1 (Pitch)		Stutter Rate	 Stutter Enable
-	Custom 2 (Bitcrush)		Custom 3 (Sample Rate)	-

Underlined parameters identify the default setting

PARAMETER DIALS

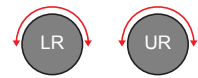





















PD01	<p>Assign Gold Dial Control Of Deluge parameters</p>	<p>Grid Shortcut</p> <p>Parameter Grid flashes</p>	<p>Learn / Input</p> <p>Chosen</p>	<p>More assignable options via sound editor. Ensure parameter (not just category) is selected.</p>
PD02	<p>Check Gold Dial Control Check parameters assigned.</p>	<p>Grid Shortcut</p> <p>Parameter Grid flashes</p>	<p>Chosen</p>	<p>Check LCD screen for parameter variation when selected and adjusted. Also check XML file.</p>
PD03	<p>Record Automation Of parameters</p>	<p>Record</p> <p>Play</p> <p>Resample</p>	<p>or</p>	<p>Can also use external MIDI from a controller that has been LEARNed</p>
PD04	<p>Delete Automation Of recorded parameters.</p>	<p>or</p>		<p>Deleting clip notes does not delete automation. They exist independently. Use (MS03) to delete both.</p>
PD05	<p>Copy Automation Of parameters</p>	<p>Learn / Input</p> <p>or</p>		<p>Can copy between different parameters, clips and song files. Automation is copied one parameter at a time at current zoom level</p>
PD06	<p>Paste Automation Of copied parameters</p>	<p>Learn / Input</p> <p>or</p>		
PD07	<p>Parameter Change / Lock Per note in clip view</p>	<p>or</p>		<p>Notes set using this method will remain set until the next sequence note starts</p>
PD08	<p>Parameter Change / Lock Per clip in song view</p>	<p>or</p>		<p>(S)</p>



































MIDI Out from Deluge to External Synths, Drums etc

MC01		Setup MIDI Sequencing Of notes			Select MIDI Channel 1-16		
MC02		MIDI Sequencing Of parameters. Pre-Req (MC01)	 Select Parameter Deluge labels do not apply. Use any button to map function.	or	+	or	
MC03		Record Automation Of MIDI parameters	Record Resample	Play 	or	CC with a '.' Indicated in the LCD screen shows that automation is already recorded.	
MC04		Change Dial Control Change MIDI Parameter but keep automation.	or	+	Parameters with automation recorded '.' are not shown with this command so no automation can be written in error.		
MC05		MIDI Note Output In a kit clip.			+	Multiple MIDI Channels / Notes on each row of a kit can be set	
					Select MIDI Channel		Select MIDI Note Value
							MIDI Channel 12 MIDI Note 60 (C3)
		+	Settings Menu contains several MIDI, CV and Gate parameters which are not specified above. These include MIDI Thru, PPQN etc. These settings apply to all songs.				











MIDI In from External Controller to Deluge (to Synths, Drums etc)

MC06	 External Controller To play Deluge Synth or Kit	Learn / Input ○ +  +  Ext Controller	<i>In Synth; any audition / row pressed will assign all. In kit, just instrument / row pressed is learned. Deluge will learn any incoming MIDI note data and map it to the clip</i>	C
MC07	 Trigger Deluge Song Via external MIDI Controller	Song ○ <i>On</i> Learn / Input ○ +  +  <i>or Rec, Play etc</i> Ext Controller	<i>Can trigger Play/Rec, Clip Mutes etc from Song Mode with ext controller. Deluge uses MIDI notes not CC values for mapping.</i>	S
MC08	 Un-Learn Ext Controller	○ Shift Learn / Input ○ +  <i>or Rec, Play etc</i>	<i>Applies to (MC06) and (MC07)</i> <i>Any already learned MIDI functions will flash when learn button alone is held.</i>	C S
MC09	 External Control Of Deluge parameter	Grid Shortcut ○ +  Shift <i>Parameter Grid flashes</i> Learn / Input ○ +  Ext Controller		C
MC10	 Un-Learn Ext Controller Of Deluge parameters	Grid Shortcut ○ +  Shift <i>Parameter Grid flashes</i> Learn / Input Shift + ○ <i>Applies to (MC09)</i>		C
MC11	 Nudge MIDI Clock	 + 		G
MC12	 Record External Notes MIDI Notes into Deluge grid Pre-requisite (MC06)	Record ○ Resample Play ○  <i>Play Sequence</i> Ext Controller	<i>Once learned, Clip does not need to be visible to report into.</i>	
MC13	4/4 Sync Scaling For unusual time signatures	Sync-scaling ○	<i>Press on 'load' clip and will flash to show enabled. On all other clips sync-scaling button will be LIT but not flash.</i>	
MC14	 Mute By External MIDI Individual kit instrument / rows	Kit On ○ Learn / Input ○ +  +  Ext Controller		

Song
 In Song Mode

<p>LO01</p>		<p>Toggle Record Arm Set arm status for clips</p>	<p>Record  Resample</p> <p>+</p> 	<p>By default audio clips are already armed with purple flashing mode.</p>	
<p>Armed clips explained</p>			<p>Record  Resample <i>Hold</i></p> <p>↓</p>  <i>Red</i> <i>Clip will not play when recording loops</i>  <i>Green</i> <i>Clip will play when recording loops</i>  <i>Red Flash</i> <i>Armed to record. Overdub will record on this audio track. Will then be the only one audible.</i>  <i>Purple Flash</i> <i>Armed to record. Overdub will record automatically on new audio track. All will be audible.</i>		
<p>LO02</p>		<p>Start Loop Record</p>	<p>Record  Resample</p> <p><i>On</i></p> <p>Play </p>	<p>Initial loop recording requires Armed & Empty Audio clips (LO01). To close loop recording but keep playing use (LO03) or (LO04)</p>	
<p>LO03</p>		<p>Close Loop Recording</p>	 <i>Of recording clip row</i>		
<p>LO04</p>		<p>Close Loop Recording And immediately play in solo</p>	<p> + </p>	<p>Useful for MIX/OUTP Loops</p>	
<p>LO05</p>		<p>Record Loop During playback</p>	<p>Record  Resample</p> <p><i>On</i></p> <p>Play </p>	 <i>(RED) Press to unmute</i>	<p>Initial loop recording requires Armed & Empty Audio clips (LO01)</p>
<p>LO06</p>		<p>Record Overdub</p>	<p>Record  Resample</p> <p><i>On</i></p> <p>Play </p> <p>Record  Resample</p> <p>+</p> 	<p>Of row directly underneath the existing audio clip. Will auto insert if already there.</p>	
<p>LO07</p>		<p>Record Overdub With continuous layering</p>	<p>Record  Resample</p> <p><i>On</i></p> <p>Play </p> <p>Record  Resample</p> <p>+</p> 	<p>Of row directly underneath the existing audio clip. End of loop, new loop row will automatically be added</p>	
<p>LO08</p>		<p>Save Loops To SD Card</p>	<p>Loop recordings are not saved by default anywhere. To save them to SD, first save song (GL09) and / or save + collect all samples (GL19).</p>		
<p>LO09</p>		<p>Tempo Detection For 'loop pedal' recording</p>	<p> + </p> <p><i>To toggle metronome OFF</i></p>	<p>Start with a blank song. Deluge will estimate and set the BPM for loop recording based on the audio received and loop close point.</p>	

Song
 In Song Mode

LO10	 Preset Tempo For Loop Recording	 <i>New Row</i>	 <i>Set Clip as Synth or Kit</i>	 Once created no note data is required. New audio clip loops will be based around this set tempo.
LO11	 Grab Tempo From existing audio clip	 +  Of Audio Clip row. Will detect and set tempo.		Can also detect tempo from the audio clip view. Tempo + Any Grid Pad.
LO12	 1.2.3 Enable Count-In Before audio recording	 +  RECOrd → COUNT in		

FM Modulation Ratios

Common FM Ratios and how to set them in Deluge. Deluge uses semitones and cents instead of ratios.

Ratio	Semitones & Cents
1:2	12
1:3	19,02
1:4	24
1:5	27,86
1:6	31,02
1:7	33,69
1:8	36
1:9	38,04
1:10	39,86
1:11	41,51
1:12	43,02

SHORTCUTS

Version 3.0

Example Shortcut symbols used in the guide

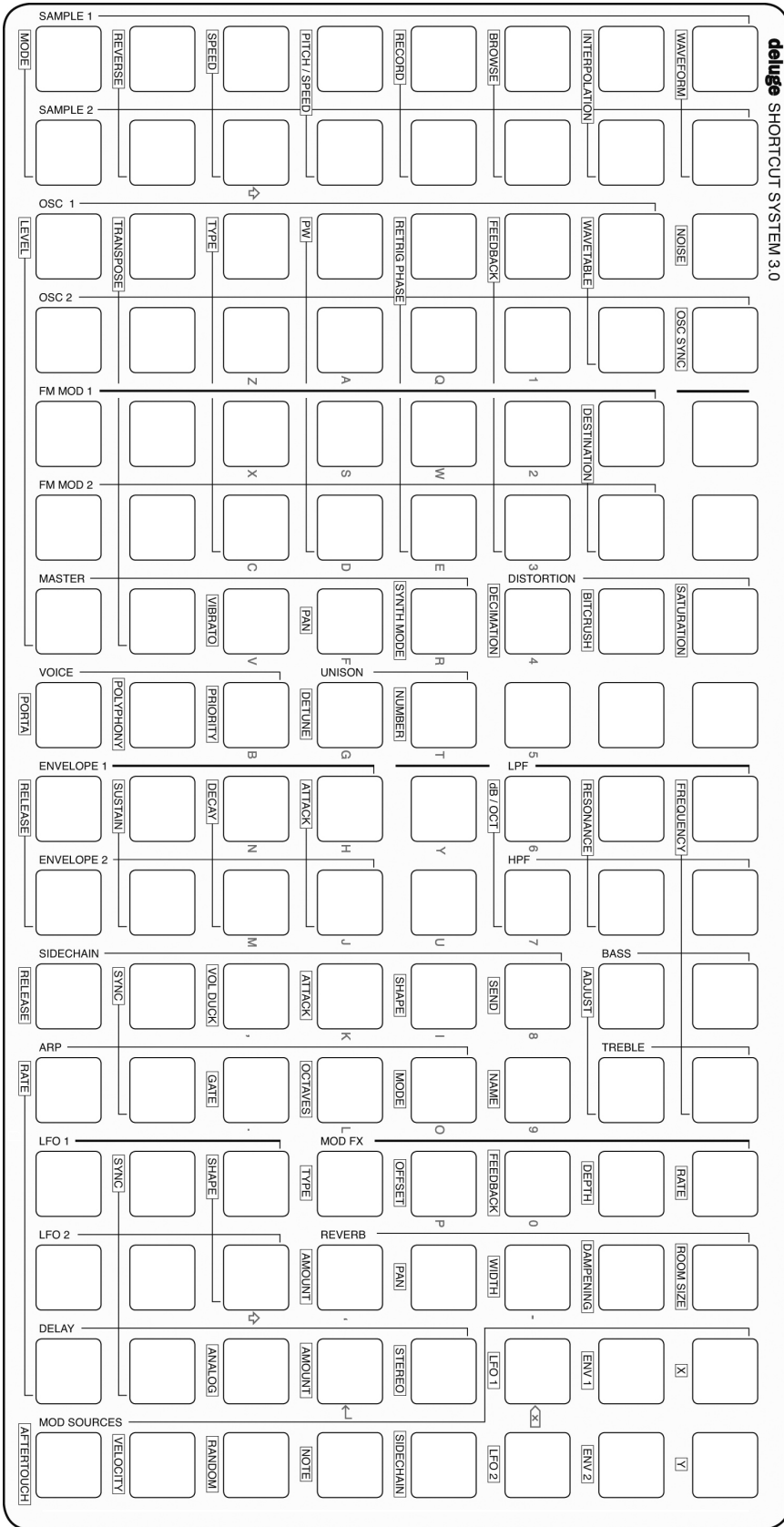

SHORTCUTS

Version 3.0

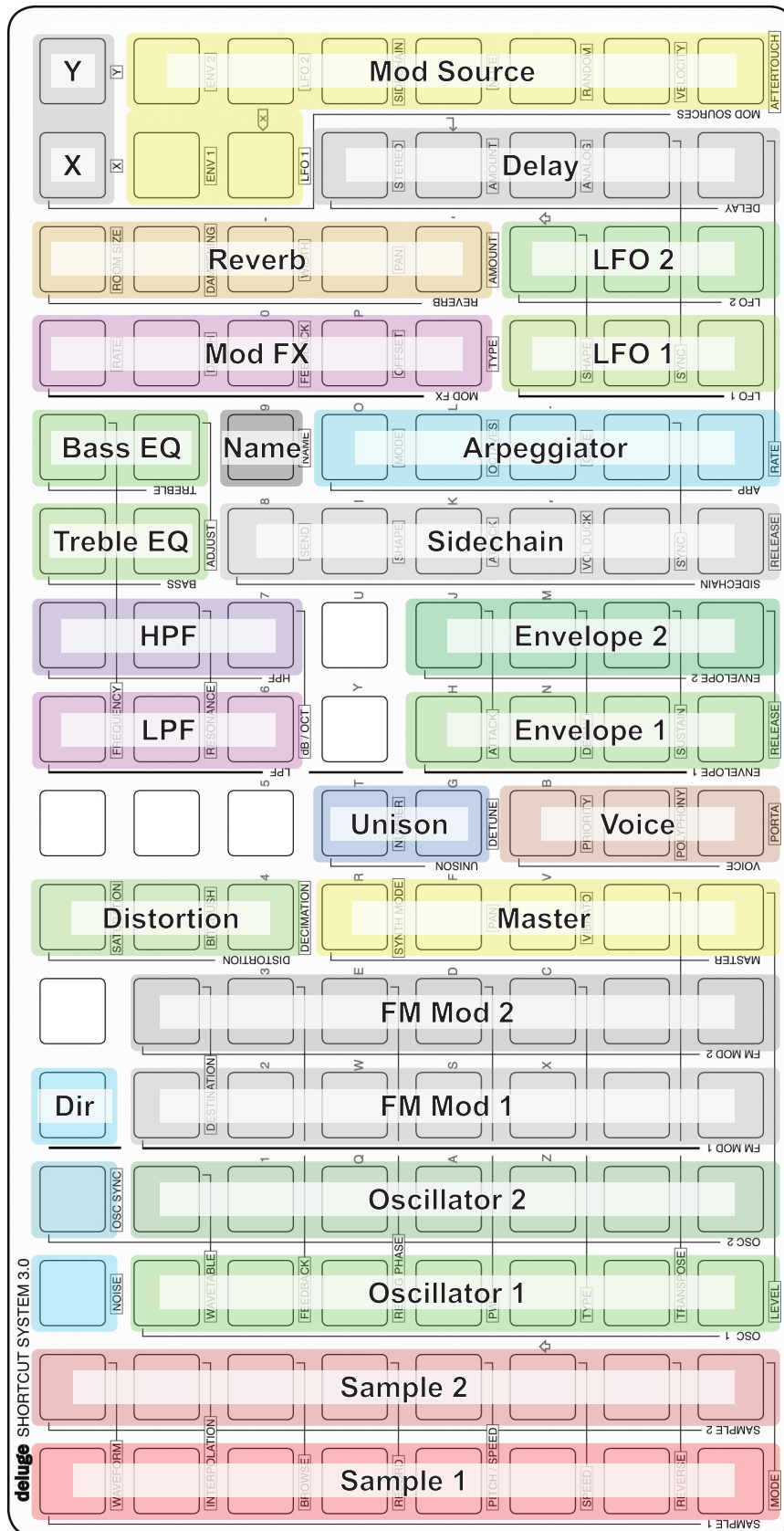

ISOMORPHIC CHORDS

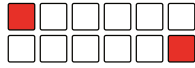

Same Note Unison

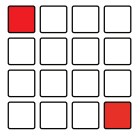

Octave

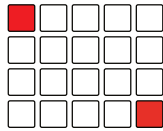
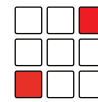

Major Seventh



Minor Seventh

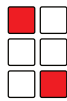
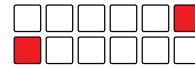

Major Sixth

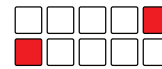

Minor Sixth

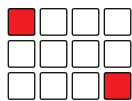
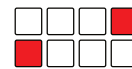

Perfect Fifth

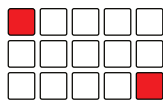

Tritone



Perfect Fourth



Major Third



ISOMORPHIC CHORDS



Left



Right

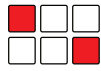

Minor Third

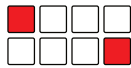

Major Second

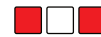

Minor Second

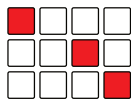

Major Triad

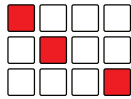
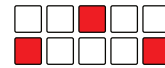

Minor Triad

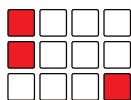
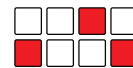

Suspended 2

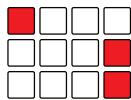
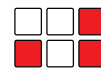

Suspended 4

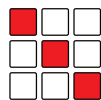
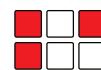

Augmented

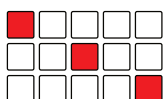
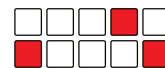

Diminished

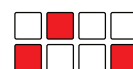

The Following people have contributed to the making of this community guide:-

- Jon Hutton. Author and developer of the original and first community guide. The inspiration and core design for this refresh.
- Adam Robertson. Contributor to the original display guide.
- AdventureKid: Resource and guide for single cycle waveforms. [Link](#)
- Mikhail Sladkomedov. Contributor to the FM Ratios.
- Flutehead. Contributor to the original guide faceplate shortcuts graphic overview.
- Manycyber. Contributor to the original guide isomorphic chord illustration.

INDEX

Index

A

Acknowledgments 292
Affect Entire 27, 29
Alpha Numeric Keyboard 30
Arming Audio Clips 176
Arpeggiator 102
Arranger 154
Arranger View 18
Audio Clip 143, 175, 180
Audio Inputs 174
Audio Playback Modes 194
Audition / Section 5
Auto Extend Mode 43

B

Battery 7
Bitcrush 217
BPM 17

C

Chords 54
Clip Length 60
Clip View 18, 20
Cloned Clips 144
Collect Media Function 151
Continuous Overdubs 203
Count In 44

CPU Performance 288
Cross Screen 62
Custom Parameter Affect Controls 131
CV 6, 18, 265, 267

D

Decimation 217
Delay 222
Distortion 217

E

Envelopes 125
EQ 219
Euclidean sequencing 70
External Microphone 6

F

File Structure 12
Filters 98
Firmware 278
Fixed Length Mode 43
FM Synthesis 75
Foot Controller 206

G

Gate 6, 268
Global MIDI Commands 206, 247–248
Grid 4
Grid Shortcuts 92

Index

H

Headphone Output 6

I

Internal Microphone 5

Isomorphic Chord Shapes 55

Iteration Dependence 64

K

Keyboard Mode 4

Kit 18

Kit Presets 15, 23, 112

Kits 107

L

Layer 208

Legacy Shortcuts 291

Loading 147, 172

Loop 191, 193, 203, 208, 210

Loop Margins 209

Looping 202

Low Frequency Oscillators 125

M

MIDI 18, 206, 235, 241

MIDI Differentiation 237–238

MIDI Thru 243

Mod FX 229

Mode 190

Modulation 5, 117

Modulation Routing Advanced 123

Monitoring 195

MPE 258–259, 261

Multi-Samples 185

Multiple Samples 114

Multiply Clip Length 61

Mute / Launch 5, 21

N

Note length 48

Nudge 243

O

On/Off 6

P

Pad Colours 281

Pan 68

Parameter Affect Controls 4

Parameter Affect Group 27

Parameter Automation 66, 70

Pitch 188

Pitch Shifting 196

Play direction 36

Polyphony 99

Power 4, 7, 16

Probability 64

Index

PSU 3, 6

R

Re-Sampling 171, 189

Recording 171, 190

Recording Pattern 40

Regular overdub 203

Reverb 224

Reverse 190, 194

Root note 52

S

Samples 173

Sampling 181, 184

Saturation 217

Saving 147

Scale 5, 50

Scroll 56

SD Card 3, 5, 8–9, 12, 171

Sections 145

Sequence 20

Sequencing 34, 56

Sidechain Compressor 127

Single Cycle Waveforms 104

Slicer 183

Song view 18, 137

Sound Editor 90

Stutter Effect 232

Subtractive Synthesis 74, 76

Swing 38

Sync-scaling 251

SYNTH 18

Synth Presets 13, 22

System Architecture 9

System Settings 276

T

Tempo 5, 17, 38, 192, 249

Tempo Magnitude Matching 250

Time Stretching 196

Transferring Presets 26

Transpose 52

Trigger clock 268

Triplets view 47

U

Undo / Redo 21

Unique Clips 162

Unison Mode 100

USB 4, 6–7

USB Host 290

V

Velocity 45

Voices 99

Index

W

Waveform Editor 191

Waveform View 190

Wavetable Synthesis 76, 79, 89

Compliance information

FCC compliance for United States

This equipment has been tested and found to comply with the limits for a Class B digital device, pursuant to Part 15 of the FCC rules. These limits are designed to provide reasonable protection against harmful interference in a residential installation. This equipment generates, uses and can radiate radio frequency energy and, if not installed and used in accordance with the instructions, may cause harmful interference to radio communications. However, there is no guarantee that interference will not occur in a particular installation. If this equipment does cause harmful interference to radio or television reception, which can be determined by turning the equipment off and on, the user is encouraged to try to correct the interference by one or more of the following measures:

- Reorient or relocate the receiving antenna.
- Increase the separation between the equipment and the receiver.
- Connect the equipment into an outlet on a circuit different from that to which the receiver is connected.
- Consult the dealer or an experienced radio/TV technician for help.

You may also find helpful the following booklet, prepared by the FCC: "How to Identify and Resolve Radio-TV Interference Problems." This booklet is available from the U.S. Government Printing Office, Washington D.C. 20402.

Changes and Modifications not expressly approved by the manufacturer or registrant of this equipment can void your authority to operate this equipment under Federal Communications Commissions rules.

In order to maintain compliance with FCC regulations shielded cables must be used with this equipment. Operation with non-approved equipment or unshielded cables is likely to result in interference to radio & television reception.

CE compliance



This product is CE marked to denote conformity with Directives 2014/30/EU (Electromagnetic Compatibility) and 2014/35/EU (Low Voltage), as amended.

Environmental Protection

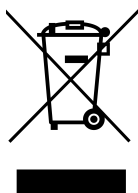

Waste electrical products should not be disposed of with household waste. Please recycle where facilities exist. Check with your local authority or retailer for recycling advice.

© Synthstrom Audible 2022

The Deluge Manual

Fourth Edition v4.0 OS

www.synthstrom.com

www.facebook.com/synthstromaudible

All rights reserved. This book or any portion thereof may not be reproduced or used in any manner whatsoever without the express written permission of the publisher except for the use of brief quotations in a book review. This book and its contents are the property of Synthstrom Audible.

Produced in partnership with Synthdawg.

www.synthdawg.com

3v2ed4

SYNTHSTROM AUDIBLE

